

Dell PowerEdge C4130 Owner's Manual

Regulatory Model: E32S Series
Regulatory Type: E32S001



Notes, cautions, and warnings

 **NOTE:** A NOTE indicates important information that helps you make better use of your computer.

 **CAUTION:** A CAUTION indicates either potential damage to hardware or loss of data and tells you how to avoid the problem.

 **WARNING:** A WARNING indicates a potential for property damage, personal injury, or death.

Copyright © 2015 Dell Inc. All rights reserved. This product is protected by U.S. and international copyright and intellectual property laws. Dell™ and the Dell logo are trademarks of Dell Inc. in the United States and/or other jurisdictions. All other marks and names mentioned herein may be trademarks of their respective companies.

2015 - 04

Rev. A01

Contents

1 About the PowerEdge C4130 system.....	8
Supported configurations on PowerEdge C4130 systems.....	8
Customer and field replaceable units.....	9
Front panel features and indicators.....	10
Back panel features and indicators.....	11
NIC indicator codes.....	13
uSATA SSD indicator codes.....	14
Redundant power supply indicator codes.....	14
Documentation matrix.....	16
Quick Resource Locator	17
2 Performing initial system configuration	18
Setting up your system.....	18
Methods of setting up and configuring the iDRAC IP address	18
Logging in to iDRAC.....	19
Methods of installing the operating system.....	19
Managing your system remotely.....	19
Downloading drivers and firmware.....	19
3 Pre-operating system management applications.....	21
Navigation keys.....	21
About System Setup.....	22
Enabling Console Redirection.....	22
Entering System Setup.....	22
System Setup Main Menu.....	22
System BIOS screen.....	22
System Information screen.....	23
Memory Settings screen.....	24
Processor Settings screen	24
SATA Settings screen	26
Boot Settings screen.....	28
Network Settings screen.....	28
Integrated Devices screen	29
Serial Communication screen.....	30
System Profile Settings screen.....	31
System Security Settings screen.....	32
Miscellaneous Settings screen.....	34
About Boot Manager.....	35

Entering Boot Manager	35
Boot Manager main menu.....	35
Changing the boot order.....	36
Choosing the system boot mode.....	36
Assigning a system and setup password.....	37
Deleting or changing an existing system password or setup password.....	37
4 Installing and removing system components.....	39
Safety instructions.....	39
Before working inside your system.....	39
After working inside your system.....	39
Recommended tools.....	40
System covers.....	40
Removing the system top cover (front).....	40
Installing the system top cover (front).....	41
Removing the system top cover (back).....	41
Installing the system top cover (back).....	42
Inside the system.....	43
Intrusion switch.....	44
Removing the intrusion switch.....	44
Installing the intrusion switch.....	45
Internal dual SD module (optional).....	46
Removing an internal SD card.....	46
Installing an internal SD card.....	46
Removing the internal dual SD module	47
Installing the internal dual SD module	49
Cooling shroud.....	49
Removing the cooling shroud.....	50
Installing the cooling shroud.....	51
Processor blank.....	51
Removing a processor blank.....	51
Installing a processor blank.....	52
System memory.....	53
General memory module installation guidelines.....	55
Mode-specific guidelines.....	55
Sample memory configurations.....	57
Removing memory modules.....	60
Installing memory modules.....	61
Processors.....	63
Removing a heat sink.....	64
Removing a processor.....	65
Installing a processor.....	69

Installing a heat sink.....	70
System battery.....	72
Replacing the system battery.....	72
PCIe shroud.....	74
Removing the PCIe shroud.....	74
Installing the PCIe shroud.....	75
Expansion card riser and expansion cards.....	76
Expansion card installation guidelines.....	76
Removing the expansion card riser.....	78
Installing the expansion card riser.....	79
Removing expansion cards.....	80
Installing expansion cards.....	81
Expansion card cabling diagrams.....	83
Power supply units.....	85
Hot Spare feature.....	85
Removing the power supply unit blank.....	86
Installing the power supply unit blank.....	87
Removing an AC power supply unit.....	87
Installing an AC power supply unit.....	88
Hard drives.....	89
Removing the optional 2.5 inch hard drive cage.....	89
Installing the optional 2.5 inch hard drive cage.....	90
Removing the optional 2.5 inch hard drive cage cover.....	91
Installing the optional 2.5 inch hard drive cage cover.....	92
Removing 2.5 inch cabled hard drives from the hard drive cage.....	93
Installing a 2.5 inch cabled hard drive into the hard drive cage.....	95
Hard drive cabling diagrams.....	97
uSATA SSDs.....	99
Removing a 1.8 inch uSATA SSD blank.....	99
Installing a 1.8 inch uSATA SSD blank.....	100
Removing a 1.8 inch uSATA SSD carrier.....	100
Installing a 1.8 inch uSATA SSD carrier.....	101
Removing a 1.8 inch uSATA SSD from a SSD carrier.....	102
Installing a 1.8 inch uSATA SSD into a SSD carrier.....	103
Removing the 1.8 inch uSATA SSD cage.....	104
Installing the 1.8 inch uSATA SSD cage.....	105
Removing the 1.8 inch uSATA SSD backplane.....	105
Installing the 1.8 inch uSATA SSD backplane.....	106
Internal USB memory key (optional).....	107
Replacing the internal USB key.....	107
Cable routing clip.....	108
Removing the cable routing clip.....	108

Installing the cable routing clip.....	109
System board.....	110
Removing the system board.....	110
Installing the system board.....	112
Trusted Platform Module.....	115
Installing the Trusted Platform Module.....	115
Re-enabling the TPM for BitLocker users.....	116
Re-enabling the TPM for TXT users.....	116
Cooling fans.....	117
Removing a cooling fan.....	117
Installing a cooling fan.....	118
Graphics processing unit.....	119
GPU installation guidelines.....	119
Removing a GPU blank	120
Removing a GPU riser cable from the system board.....	121
Removing a GPU.....	122
Removing a GPU riser cable board.....	124
Removing the custom GPU brackets from the GPU removed from your system.....	125
Removing the GPU brackets from the replacement GPUs.....	127
Installing the GPU brackets on the GPU removed from your system.....	129
Installing the custom GPU brackets on the replacement GPU.....	130
Installing a GPU riser cable board.....	130
Installing a GPU blank.....	131
Installing a GPU.....	132
Installing a GPU riser cable on the system board.....	132
GPU cabling diagrams.....	134
GPU switch board (optional).....	148
Removing the optional GPU switch board	148
Installing the optional GPU switch board	149
Control panel module.....	150
Removing the control panel module.....	150
Installing the control panel module.....	151

5 Troubleshooting your system..... 153

Safety first—for you and your system.....	153
Troubleshooting system startup failure.....	153
Troubleshooting external connections.....	153
Troubleshooting the video subsystem.....	153
Troubleshooting a USB device.....	154
Troubleshooting a serial I/O device.....	154
Troubleshooting a NIC.....	155
Troubleshooting a wet system.....	155

Troubleshooting a damaged system.....	156
Troubleshooting the system battery.....	157
Troubleshooting power supply units.....	158
Troubleshooting power source problems.....	158
Troubleshooting power supply unit problems.....	158
Troubleshooting cooling problems.....	159
Troubleshooting cooling fans.....	159
Troubleshooting system memory.....	160
Troubleshooting an internal USB key.....	161
Troubleshooting an SD card.....	161
Troubleshooting a hard drive.....	162
Troubleshooting a storage controller.....	163
Troubleshooting expansion cards.....	164
Troubleshooting processors.....	164
Troubleshooting a GPU.....	165
System messages.....	165
Warning messages.....	165
Diagnostic messages.....	165
Alert messages.....	166
6 Using system diagnostics.....	167
Dell Embedded System Diagnostics.....	167
When to use the Embedded System Diagnostics.....	167
Running the Embedded System Diagnostics from Boot Manager.....	167
Running the Embedded System Diagnostics from the Dell Lifecycle Controller.....	168
System diagnostic controls.....	168
7 Jumpers and connectors.....	169
System board jumper settings.....	169
System board connectors.....	170
Disabling a forgotten password.....	171
8 Technical specifications.....	173
9 Getting help.....	177
Contacting Dell.....	177
Locating your system service tag.....	177
Mini Express Service Tag.....	178
Quick Resource Locator	178

About the PowerEdge C4130 system

The Dell PowerEdge C4130 rack servers support up to:

- Two Intel Xeon E5-2600 v3 processors
- Sixteen DIMMs
- Four 2.5 inch hard drives (optional)
- Two 1.8 inch solid state drives (SSDs)
- Two power supply units (PSUs)
- Four graphics processing units (GPUs)

 **NOTE:** All GPU cards must be of the same type and model. Mixing GPUs is not supported.

 **NOTE:** The PSU 2 slot also functions as the optional 2.5 inch hard drive cage slot. If you install the optional 2.5 inch hard drives, your system will not support the redundancy feature.

Supported configurations on PowerEdge C4130 systems

Table 1. Supported configurations

PowerEdge C4130 systems	Configuration type	Description	Expansion card slot 1	Expansion card slot 2
Single processor systems	A	Supports four GPUs and a GPU switch board.	x8	x16
	E	Supports two GPUs but does not support a GPU switch board.	x8	Not supported
Dual processor systems	B	Supports four GPUs and a GPU switch board.	x8	x16
	C	Supports four GPUs but does not support a GPU switch board.	x8	x8
	D	Supports two GPUs but does not support a GPU switch board.	x16	x16
	G	Supports four GPUs and a GPU switch board with dual GPU virtual mode.	x16	x16
	F	Supports two GPUs but does not support a GPU switch board.	x8	x8

PowerEdge C4130 systems	Configuration type	Description	Expansion card slot 1	Expansion card slot 2
	H	Supports three GPUs but does not support a GPU switch board.	x8	x8
	I	Supports three GPUs but does not support a GPU switch board.	x8	Not supported

 **NOTE:** Incorrect removal and installation of the GPUs will cause operational issues to your system.

Customer and field replaceable units

The following components are Customer Replaceable Units (CRUs):

- Cooling fans
- Expansion card riser
- Expansion cards
- Internal dual SD module (IDSDM)
- SD cards
- Internal USB keys
- Power supply units (PSUs)
- 1.8 inch uSATA SSDs
- 1.8 inch uSATA SSD cage
- 1.8 inch uSATA SSD backplane
- 2.5 inch hard drives
- 2.5 inch hard drive cage
- Memory modules
- PCI shroud
- Cooling shroud
- Cable routing clip
- Heat sinks and processors

The following components are Field Replaceable Units (FRUs). Removal and installation procedures should be performed only by Dell certified service technicians.

- Graphics processing units (GPUs)
- GPU switch board
- GPU riser cable board
- GPU brackets
- GPU blanks
- Intrusion switch
- System board
- Trusted Platform Module (TPM)
- System battery

- Control panel module

Front panel features and indicators

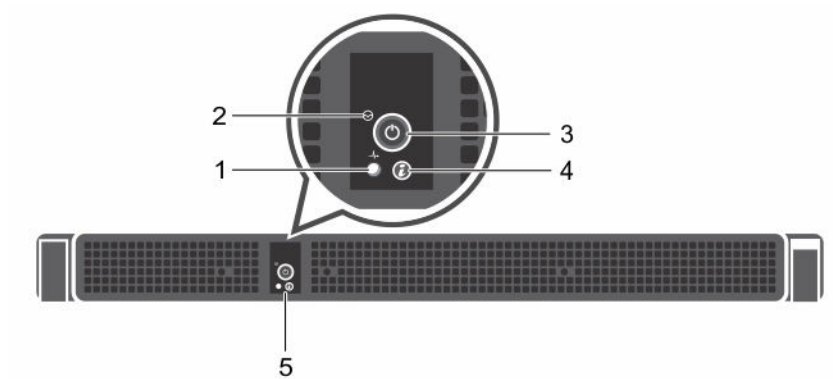





Figure 1. Front panel features and indicators

Item	Indicator, button, or connector	Icon	Description
1	Health indicator		<p>Indicates the health of the system.</p> <ul style="list-style-type: none"> • If the system is on and in good health, the indicator lights solid blue. No corrective action is required. • The indicator blinks amber if the system is on or in standby, and if any error exists (for example, a failed fan). See the System Event Log or system messages for the specific issue. For more information on error messages, see the Dell Event and Error Messages Reference Guide at dell.com/esmmanuals. Invalid memory configurations can cause the system to halt at startup without any video output. See Getting help.
2	Ambient air temperature sensor		Measures the ambient air temperature.
3	Power-on indicator, power button		<p>The power-on indicator lights when the system power is on. The power button controls the power supply output to the system.</p> <p> NOTE: On ACPI-compliant operating systems, turning off the system using the power button causes the system to perform a graceful shutdown before power to the system is turned off.</p>
4	System identification button		The identification button on the front and back panels can be used to locate a particular system within a rack. When one of these buttons is pressed, the corresponding system identification button on

Item	Indicator, button, or connector	Icon	Description
			<p>the back flashes until one of the buttons is pressed again.</p> <p>Press the system identification button to turn the system ID on or off.</p> <p>If the system stops responding during POST, press and hold the system ID button for more than five seconds to enter BIOS progress mode.</p> <p>To reset iDRAC (if not disabled in F2 iDRAC setup), press and hold the button for more than 15 seconds.</p>
5	Control panel		Consists of the health indicator, ambient air temperature sensor, power-on indicator, power button, and the system identification button.

Back panel features and indicators

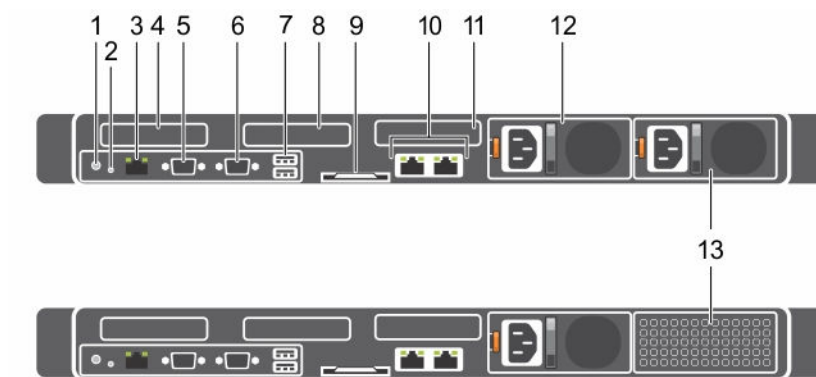







Figure 2. Back panel features and indicators—PowerEdge C4130

Item	Indicator, button, or connector	Icon	Description
1	System identification button		<p>The identification button on the front and back panels can be used to locate a particular system within a rack. When one of these buttons is pressed, the corresponding system identification button on the back flashes until one of the buttons is pressed again.</p> <p>Press the system identification button to turn the system ID on or off.</p> <p>If the system stops responding during POST, press and hold the system ID button for more than five seconds to enter BIOS progress mode.</p>

Item	Indicator, button, or connector	Icon	Description
			To reset iDRAC (if not disabled in F2 iDRAC setup), press and hold the button for more than 15 seconds.
2	NMI button		Used to troubleshoot software and device driver errors when running certain operating systems. This button can be pressed using the end of a paper clip. Use this button only if directed to do so by qualified support personnel or by the operating system documentation.
3	iDRAC8 Enterprise port		Dedicated management port.
4	Half-height PCIe expansion card slot 1		Allows you to connect half-height, half-length, low profile PCI Express expansion cards.
5	Serial connector		Allows you to connect a serial device to the system.
6	Video connector		Allows you to connect a VGA display to the system.
7	USB connector (2)		Allows you to connect USB devices to the system. The ports are USB 3.0-compliant.
8	Half-height PCIe expansion card slot 2		Allows you to connect half-height, half-length, low profile PCI Express expansion cards.
9	Information tag		A slide-out label panel which allows you to record system information such as Service Tag, NIC, MAC address and so on as per your need.
10	Ethernet connector (2)		Two integrated 10/100/1000/Mbps NIC connectors.
11	Hard drive (2)		Up to two 1.8 inch uSATA SSDs.
12	Power supply unit (PSU1)		One 1600 W or 1100 W PSU.
13	Power supply unit (PSU2)/2.5 inch Hard drive cage slot		One 1600 W or 1100 W PSU or up to four 2.5 inch cabled hard drives.

uSATA SSD indicator codes



Figure 4. uSATA SSD indicators

1. uSATA SSD activity indicator
2. uSATA SSD status indicator
3. uSATA SSD

NOTE: If the SSD is in Advanced Host Controller Interface (AHCI) mode, the status indicator (on the right side) does not function and remains off.

Drive-status indicator pattern	Condition
Blinks green two times per second	Identifying drive or preparing for removal.
Off	Drive ready for insertion or removal.
	NOTE: The drive status indicator remains off until all hard drives are initialized after the system is turned on. Drives are not ready for insertion or removal during this time.
Blinks green, amber, and turns off	Predicted drive failure
Blinks amber four times per second	Drive failed
Steady green	Drive online
Blinks green three seconds, amber three seconds, and turns off six seconds	Rebuild aborted

Redundant power supply indicator codes





Each AC power supply unit (PSU) has an illuminated translucent handle that indicates whether power is present or whether a power fault has occurred.



Figure 5. AC PSU status indicator

1. AC PSU status indicator/handle

Convention	Power Indicator Pattern	Description
A	Green	A valid power source is connected to the PSU and the PSU is operational.
B	Flashing green	When the firmware of the PSU is being updated, the PSU handle flashes green. CAUTION: Do not disconnect the power cord or unplug the PSU when updating firmware. If firmware update is interrupted, the PSUs will not function. You must roll back the PSU firmware by using Life cycle controller. See <i>Dell Lifecycle Controller User's Guide</i> at dell.com/esmmanuals .
C	Flashing green and turns off	When hot-adding a PSU, the PSU handle flashes green five times at 4 Hz rate and turns off. This indicates that there is a PSU mismatch with respect to efficiency, feature set, health status, and supported voltage. Replace the PSU with a PSU that matches the capacity of the PSU. CAUTION: For AC power supplies, use only PSUs with the Extended Power Performance (EPP) label on the back. Mixing PSUs from previous generations of PowerEdge servers can result in a PSU mismatch condition or failure to power on.
D	Flashing amber	Indicates a problem with the PSU.

Convention	Power Indicator Pattern	Description
		<p> CAUTION: When correcting a PSU mismatch, replace only the PSU with the flashing indicator. Swapping the other PSU to make a matched pair can result in an error condition and unexpected system shutdown. To change from a High Output configuration to a Low Output configuration or vice versa, you must power down the system.</p> <p> CAUTION: AC PSUs support both 220 V and 110 V input voltages with the exception of Titanium PSUs, which support only 220 V. When two identical PSUs receive different input voltages, they can output different wattages, and trigger a mismatch.</p> <p> CAUTION: If two PSUs are used, they must be of the same type and have the same maximum output power.</p> <p> CAUTION: Combining AC and DC PSUs is not supported and triggers a mismatch.</p>
E	Not lit	Power is not connected.

Documentation matrix

The documentation matrix provides information on documents that you can refer to for setting up and managing your system.

To...	Refer to...
Install your system into a rack	Rack documentation included with your rack solution
Set up your system and know the system technical specifications	<i>Getting Started With Your System</i> that shipped with your system or see dell.com/poweredge manuals
Install the operating system	Operating system documentation at dell.com/operatingsystem manuals
Get an overview of the Dell Systems Management offerings	Dell OpenManage Systems Management Overview Guide at dell.com/openmanage manuals
Configure and log in to iDRAC, set up managed and management system, know the iDRAC features and troubleshoot using iDRAC	Integrated Dell Remote Access Controller User's Guide at dell.com/esm manuals
Know about the RACADM subcommands and supported RACADM interfaces	RACADM Command Line Reference Guide for iDRAC and CMC at dell.com/esm manuals
Launch, enable and disable Lifecycle Controller, know the features, use and troubleshoot Lifecycle Controller	Dell Lifecycle Controller User's Guide at dell.com/esm manuals

To...	Refer to...
Use Lifecycle Controller Remote Services	Dell Lifecycle Controller Remote Services Quick Start Guide at dell.com/esmmanuals
Set up, use, and troubleshoot OpenManage Server Administrator	Dell OpenManage Server Administrator User's Guide at dell.com/openmanagemanuals
Install, use, and troubleshoot OpenManage Essentials	Dell OpenManage Essentials User's Guide at dell.com/openmanagemanuals
Know the features of the storage controller cards, deploy the cards, and manage the storage subsystem	Storage controller documentation at dell.com/storagecontrollermanuals
Check the event and error messages generated by the system firmware and agents that monitor system components	Dell Event and Error Messages Reference Guide at dell.com/esmmanuals

Quick Resource Locator

Use the Quick Resource Locator (QRL) to get immediate access to system information and how-to videos. This can be done by visiting dell.com/QRL or by using your smartphone or tablet and a model specific Quick Resource (QR) code located on your Dell PowerEdge system. To try out the QR code, scan the following image.



Performing initial system configuration

After you receive your system, you must set up your system, install the operating system if it is not pre-installed, and set up and configure the system iDRAC IP address.

Setting up your system

1. Unpack the system.
2. Install the system into the rack. For more information on installing the system into the rack, see your system *Rack Installation Placemat* at dell.com/poweredgemanuals.
3. Connect the peripherals to the system.
4. Connect the system to its electrical outlet.
5. Turn the system on by pressing the power button or using iDRAC.
6. Turn on the attached peripherals.

Methods of setting up and configuring the iDRAC IP address

You can set up the Integrated Dell Remote Access Controller (iDRAC) IP address by using one of the following interfaces:

1. iDRAC Settings utility.
2. Lifecycle Controller.
3. Dell Deployment Toolkit.

You can configure iDRAC IP using:

1. iDRAC Web Interface.

For more information, see the Integrated Dell Remote Access Controller User's Guide.

2. Remote Access Controller Admin (RACADM).

For more information, see the RACADM Command Line Interface Reference Guide and the Integrated Dell Remote Access Controller User's Guide.

3. Remote Services that includes Web Services Management (WS-Man). For more information, see the Lifecycle Controller Remote Services Quick Start Guide.

For more information on setting up and configuring iDRAC, see the Integrated Dell Remote Access Controller User's Guide at dell.com/esmanuals.

Logging in to iDRAC

You can log in to iDRAC as an iDRAC local user, a Microsoft Active Directory user, or a Lightweight Directory Access Protocol (LDAP) user. You can also log in by using Single Sign-On or a Smart Card. The default user name is **root** and password is **calvin**. For more information on logging in to iDRAC and iDRAC licenses, see the Integrated Dell Remote Access Controller User's Guide at dell.com/esmmanuals.

You can also access iDRAC using RACADM. For more information, see the RACADM Command Line Interface Reference Guide and the Integrated Dell Remote Access Controller User's Guide available at dell.com/esmmanuals.

Methods of installing the operating system

If the system is shipped without an operating system, install the supported operating system on the system by using one of the following methods:

- Dell Systems Management Tools and Documentation media. See the operating system documentation at dell.com/operatingsystemmanuals.
- Dell Lifecycle Controller. See the Lifecycle Controller documentation at dell.com/esmmanuals.
- Dell OpenManage Deployment Toolkit. See the OpenManage documentation at dell.com/openmanagemanuals.

For information on the list of operating systems supported on your system, see the operating systems support matrix at dell.com/ossupport.

Managing your system remotely

To perform out-of-band systems management using iDRAC, you must configure iDRAC for remote accessibility, set up the management station and managed system, and configure the supported Web browsers. For more information, see the Integrated Dell Remote Access Controller User's Guide at dell.com/esmmanuals.

You can also remotely monitor and manage the server by using the Dell OpenManage Server Administrator (OMSA) software and OpenManage Essentials (OME) systems management console. For more information, see dell.com/openmanagemanuals.

Downloading drivers and firmware

It is recommended that you download and install the latest BIOS, drivers, and systems management firmware on your system.

Prerequisites

Ensure that you clear the web browser cache.

Steps

1. Go to dell.com/support/drivers.
2. In the **Product Selection** section, enter the Service Tag of your system in the **Service Tag or Express Service Code** field.
 **NOTE:** If you do not have the Service Tag, select **Automatically detect my Service Tag for me** to allow the system to automatically detect your Service Tag, or select **Choose from a list of all Dell products** to select your product from the **Product Selection** page.
3. Click **Get drivers and downloads**.
The drivers that are applicable to your selection are displayed.
4. Download the drivers you require to a USB drive, CD, or DVD.

Pre-operating system management applications

The pre-operating system management applications for your system helps you manage different settings and features without booting to the operating system.

Your system has the following pre-operating system management applications:

- System Setup
- Boot Manager
- Dell Lifecycle Controller

Navigation keys

The navigation keys can help you quickly access the pre-operating system management applications.

Key	Description
<Page Up>	Moves to the previous screen.
<Page Down>	Moves to the next screen.
Up arrow	Moves to the previous field.
Down arrow	Moves to the next field.
<Enter>	Enables you to type a value in the selected field (if applicable) or follow the link in the field.
Spacebar	Expands or collapses a drop-down list, if applicable.
<Tab>	Moves to the next focus area.
	 NOTE: This feature is applicable for the standard graphic browser only.
<Esc>	Moves to the previous page until you view the main screen. Pressing <Esc> in the main screen exits System BIOS or iDRAC Settings/ Device Settings/Service Tag Settings and proceeds with system boot.
<F1>	Displays the System Setup help.

About System Setup

Using **System Setup**, you can configure the BIOS settings, iDRAC settings, and device settings of your system.

You can access **System Setup** in two ways:

- Standard Graphical Browser — This is enabled by default.
- Text Browser — This is enabled by using Console Redirection.

 **NOTE:** By default, help text for the selected field is displayed in the graphical browser. To view the help text in the text browser, press <F1>.

Enabling Console Redirection

To enable **Console Redirection**, in **System Setup**, select **System BIOS** → **Serial Communication** → **On with Console Redirection via COMx** (or **Auto** if a serial terminal is present).

Entering System Setup

1. Turn on or restart your system.
2. Press <F2> immediately after you see the following message:
<F2> = System Setup

If your operating system begins to load before you press <F2>, wait for the system to finish booting, and then restart your system and try again.

System Setup Main Menu

Option	Description
System BIOS	Enables you to configure BIOS settings.
iDRAC Settings	Enables you to configure iDRAC settings. The iDRAC Settings utility is an interface to set up and configure the iDRAC parameters by using UEFI. You can enable or disable various iDRAC parameters by using the iDRAC Settings utility. For more information about this utility, see the Integrated Dell Remote Access Controller User's Guide at dell.com/esmmanuals .
Device Settings	Enables you to configure device settings.

System BIOS screen

By using the **System BIOS** screen, you can view the BIOS settings as well as edit specific functions such as **Boot Order**, **System Password**, **Setup Password**, setting the RAID mode, and enabling or disabling USB ports.

To view the System BIOS screen click **System BIOS** on the **System Setup Main Menu**.

The **System BIOS** screen details are explained as follows:

Menu Item	Description
System Information	Displays information about the system such as the system model name, BIOS version and Service Tag.
Memory Settings	Displays information and options related to the installed memory.
Processor Settings	Displays information and options related to the processor such as speed, cache size.
SATA Settings	Displays options to enable or disable the integrated SATA controller and ports.
Boot Settings	Displays options to specify the boot mode (BIOS or UEFI). Enables you to modify UEFI and BIOS boot settings.
Network Settings	Displays options to change the network settings.
Integrated Devices	Displays options to enable or disable integrated device controllers and ports and specify related features and options.
Serial Communication	Displays options to enable or disable the serial ports and specify related features and options.
System Profile Settings	Displays options to change the processor power management settings, memory frequency, and so on.
System Security	Displays options to configure the system security settings such as, system password, setup password, TPM security. It also enables or disables support for the power and NMI buttons on the system.
Miscellaneous Settings	Displays options to change the system date, time, and so on.

System Information screen

You can use the **System Information** screen to view system properties such as Service Tag, system model, and the BIOS version.

To view the **System Information** click **System Setup Main Menu** → **System BIOS** → **System Information**.

The **System Information** screen details are explained as follows:



Menu Item	Description
System Model Name	Displays the system model name.
System BIOS Version	Displays the BIOS version installed on the system.
System Management Engine Version	Displays the current revision of the Management Engine firmware.
System Service Tag	Displays the system service tag.
System Manufacturer	Displays the name of the system manufacturer.
System Manufacturer Contact Information	Displays the contact information of the system manufacturer.
System CPLD Version	Displays the current revision of the system CPLD firmware.
UEFI Compliance Version	Displays the system firmware UEFI compliance level.

Memory Settings screen

You can use the **Memory Settings** screen to view all the memory settings as well as enable or disable specific memory functions such as system memory testing and node interleaving.

You can view the **Memory Setting** screen by clicking **System Setup Main Menu** → **System BIOS** → **Memory Settings**.

The **Memory Settings** screen details are explained as follows:

Menu Item	Description
System Memory Size	Displays the amount of memory installed in the system.
System Memory Type	Displays the type of memory installed in the system.
System Memory Speed	Displays the system memory speed.
System Memory Voltage	Displays the system memory voltage.
Video Memory	Displays the amount of video memory.
System Memory Testing	Specifies whether system memory tests are run during system boot. Options are Enabled and Disabled . By default, the System Memory Testing option is set to Disabled .
Memory Operating Mode	<p>Specifies the memory operating mode. The options available are Optimizer Mode, Advanced ECC Mode, Mirror Mode, Spare Mode, Spare with Advanced ECC Mode, and Dell Fault Resilient Mode. By default, the Memory Operating Mode option is set to Optimizer Mode.</p> <p> NOTE: The Memory Operating Mode can have different default and available options based on the memory configuration of your system.</p> <p> NOTE: The Dell Fault Resilient Mode establishes an area of memory that is fault resilient. This mode can be used by an operating system that supports the feature to load critical applications or enables the operating system kernel to maximize system availability.</p>
Node Interleaving	Specifies if Non-Uniform Memory architecture (NUMA) is supported. If this field is Enabled , memory interleaving is supported if a symmetric memory configuration is installed. If Disabled , the system supports NUMA (asymmetric) memory configurations. By default, Node Interleaving option is set to Disabled .
Snoop Mode	Specifies the Snoop Mode options. Snoop Mode options available are Home Snoop , Early Snoop , Cluster on Die . By default, the Snoop Mode option is set to Early Snoop . The field is available only when Node Interleaving is Disabled .

Processor Settings screen

You can use the **Processor Settings** screen to view the processor settings and perform functions such as enabling virtualization technology, hardware prefetcher, and logical processor idling.

You can view the **Processor Settings** screen by clicking **System Setup Main Menu** → **System BIOS** → **Processor Settings**.

The **Processor Settings** screen details are explained as follows:

Menu Item	Description
Logical Processor	Enables or disables the logical processors and displays the number of logical processors. If the Logical Processor option is set to Enabled , the BIOS displays all the logical processors. If this option is set to Disabled , the BIOS displays only one logical processor per core. By default, the Logical Processor option is set to Enabled .
Alternate RTID (Requestor Transaction ID) Setting	Enables you to allocate more RTIDs to the remote socket, thereby increasing cache performance between the sockets or easing work in normal mode for NUMA. By default, the Alternate RTID (Requestor Transaction ID) Setting is set to Disabled .
Virtualization Technology	Enables or disables the additional hardware capabilities provided for virtualization. By default, the Virtualization Technology option is set to Enabled .
Address Translation Service (ATS)	Defines the Address Translation Cache (ATC) for devices to cache the DMA transactions. This field provides an interface to a chipset's Address Translation and Protection Table to translate DMA addresses to host addresses. By default, the option is set to Enabled .
Adjacent Cache Line Prefetch	Optimizes the system for applications that require high utilization of sequential memory access. By default, the Adjacent Cache Line Prefetch option is set to Enabled . You can disable this option for applications that require high utilization of random memory access.
Hardware Prefetcher	Enables or disables the hardware prefetcher. By default, the Hardware Prefetcher option is set to Enabled .
DCU Streamer Prefetcher	Enables or disables the Data Cache Unit (DCU) streamer prefetcher. By default, the DCU Streamer Prefetcher option is set to Enabled .
DCU IP Prefetcher	Enables or disables the Data Cache Unit (DCU) IP prefetcher. By default, the DCU IP Prefetcher option is set to Enabled .
Execute Disable	Enables or disables the execute disable memory protection technology. By default, the Execute Disable option is set to Enabled .
Logical Processor Idling	Enables or disables the operating system capability to put logical processors in the idling state in order to reduce power consumption. By default, the option is set to Disabled .
Configurable TDP	Allows reconfiguration of Thermal Design Power (TDP) to lower levels. TDP refers to the maximum amount of power the cooling system is required to dissipate.

Menu Item	Description
X2Apic Mode	Enables or disables the X2Apic mode.
Number of Cores per Processor	Controls the number of enabled cores in each processor. By default, the Number of Cores per Processor option is set to All .
Processor 64-bit Support	Specifies if the processor(s) support 64-bit extensions.
Processor Core Speed	Displays the maximum core frequency of the processor.
Processor 1	 NOTE: Depending on the number of installed CPUs, there may be up to four processor listings. The following settings are displayed for each processor installed in the system.
Family-Model-Stepping	Displays the family, model and stepping of the processor as defined by Intel.
Brand	Displays the brand name reported by the processor.
Level 2 Cache	Displays the total L2 cache.
Level 3 Cache	Displays the total L3 cache.
Number of Cores	Displays the number of cores per processor.

SATA Settings screen

You can use the **SATA Settings** screen to view the SATA settings of SATA devices and enable RAID on your system.

You can view the **SATA Settings** screen by clicking **System Setup Main Menu** → **System BIOS** → **SATA Settings**.

The **SATA Settings** screen details are explained below.



Menu Item	Description
Embedded SATA	Enables the embedded SATA to be set to Off , ATA , AHCI , or RAID modes. By default, the Embedded SATA option is set to AHCI .
Security Freeze Lock	Sends Security Freeze Lock command to the Embedded SATA drives during POST. This option is only applicable to ATA and AHCI mode.
Write Cache	Enables or disables the command for Embedded SATA drives during POST.
Port A	Sets the drive type of the selected device. For Embedded SATA settings in ATA mode, set this field to Auto to enable BIOS support. Set it to OFF to turn off BIOS support. For AHCI mode or RAID mode, BIOS always enables support.
Model	Displays the drive model of the selected device.
Drive Type	Displays the type of drive attached to the SATA port.
Capacity	Displays the total capacity of the hard drive. The field is undefined for removable media devices such as optical drives.

Menu Item	Description
Port B	Sets the drive type of the selected device. For Embedded SATA settings in ATA mode, set this field to Auto to enable BIOS support. Set it to OFF to turn off BIOS support. For AHCI mode or RAID mode, BIOS always enables support.
Model	Displays the drive model of the selected device.
Drive Type	Displays the type of drive attached to the SATA port.
Capacity	Displays the total capacity of the hard drive. The field is undefined for removable media devices such as optical drives.
Port C	Sets the drive type of the selected device. For Embedded SATA settings in ATA mode, set this field to Auto to enable BIOS support. Set it to OFF to turn off BIOS support. For AHCI mode or RAID mode, BIOS always enables support.
Model	Displays the drive model of the selected device.
Drive Type	Displays the type of drive attached to the SATA port.
Capacity	Displays the total capacity of the hard drive. The field is undefined for removable media devices such as optical drives.
Port D	Sets the drive type of the selected device. For Embedded SATA settings in ATA mode, set this field to Auto to enable BIOS support. Set it to OFF to turn off BIOS support. For AHCI mode or RAID mode, BIOS always enables support.
Model	Displays the drive model of the selected device.
Drive Type	Displays the type of drive attached to the SATA port.
Capacity	Displays the total capacity of the hard drive. The field is undefined for removable media devices such as optical drives.
Port E	Sets the drive type of the selected device. For Embedded SATA settings in ATA mode, set this field to Auto to enable BIOS support. Set it to OFF to turn off BIOS support. For AHCI mode or RAID mode, BIOS always enables support.
Model	Displays the drive model of the selected device.
Drive Type	Displays the type of drive attached to the SATA port.
Capacity	Displays the total capacity of the hard drive. The field is undefined for removable media devices such as optical drives.
Port F	Sets the drive type of the selected device. For Embedded SATA settings in ATA mode, set this field to Auto to enable BIOS support. Set it to OFF to turn off BIOS support. For AHCI mode or RAID mode, BIOS always enables support.

Boot Settings screen

You can use the **Boot Settings** screen to set the Boot mode to either **BIOS** or **UEFI**. It also enables you to specify the boot order.

To view the **Boot Settings** screen, click **System Setup Main Menu** → **System BIOS** → **Boot Settings**.

Menu Item	Description
Boot Mode	<p>Enables you to set the boot mode of the system.</p> <p> CAUTION: Switching the boot mode may prevent the system from booting if the operating system is not installed in the same boot mode.</p> <p> NOTE: Setting this field to UEFI disables the BIOS Boot Settings menu. Setting this field to BIOS disables the UEFI Boot Settings menu.</p> <p>If the operating system supports UEFI, you can set this option to UEFI. Setting this field to BIOS allows compatibility with non-UEFI operating systems. By default, the Boot Mode option is set to BIOS.</p>
Boot Sequence Retry	<p>Enables or disables the Boot Sequence Retry feature. If this field is enabled and the system fails to boot, the system reattempts the boot sequence after 30 seconds. By default, the Boot Sequence Retry option is set to Enabled.</p>
Hard-Disk Failover	<p>Specifies which devices in the Hard-Disk Drive Sequence are attempted in the boot sequence. When the option is set to Disabled, only the first hard disk device in the list is attempted to boot. When set to Enabled, all hard disk devices are attempted in the order, as listed in the Hard-Disk Drive Sequence. This option is not enabled for UEFI Boot Mode.</p>
Boot Option Settings	<p>Configures the boot sequence and the boot devices.</p>

Network Settings screen

You can use the **Network Settings** screen to modify PXE device settings. Network Settings are only available in UEFI boot mode. BIOS does not control network settings in the BIOS boot mode. For BIOS boot mode, the network settings are handled by the network controllers option ROM.

To view the **Network Settings** screen, click **System Setup Main Menu** → **System BIOS** → **Network Settings**.



Menu Item	Description
PXE Device n (n = 1 to 4)	<p>Enables or disables the device. When enabled, a UEFI boot option is created for the device.</p>
PXE Device n Settings (n = 1 to 4)	<p>Allows you to control the configuration of the PXE device.</p>

Integrated Devices screen

You can use the **Integrated Devices** screen to view and configure the settings of all integrated devices including the video controller, integrated RAID controller, and the USB ports.

You can view the **Integrated Devices** screen by clicking **System Setup Main Menu** → **System BIOS** → **Integrated Devices**.



The **Integrated Devices** screen details are explained below.

Menu Item	Description
USB 3.0 Setting	Enables or disables the USB 3.0 support. Enable this option only if your operating system supports USB 3.0. If you disable this option, devices operate at USB 2.0 speed. USB 3.0 is disabled by default.
User Accessible USB Ports	Enables or disables the USB ports. Selecting Only Back Ports On disables the front USB ports, selecting All Ports Off disables all USB ports. The USB keyboard and mouse operates during boot process in certain operating systems. After the boot process is complete, the USB keyboard and mouse do not work if the ports are disabled.  NOTE: Selecting Only Back Ports On and All Ports Off will disable the USB management port and also restrict access to iDRAC features.
Internal USB Port	Enables or disables the internal USB port. By default, the option is set to Enabled .
Integrated Network Card 1	Enables or disables the integrated network card.
Embedded NIC1 and NIC2	 NOTE: The Embedded NIC1 and NIC2 option is only available on systems that do not have Integrated Network Card 1 . Enables or disables the Embedded NIC1 and NIC2. If set to Disabled , the NIC may still be available for shared network access by the embedded management controller. The embedded NIC1 and NIC2 option is only available on systems that do not have NDCs. This option is mutually exclusive with the Integrated Network Card 1 option. Configure this function using the NIC management utilities of the system.
I/OAT DMA Engine	Enables or disables the I/OAT option. Enable only if the hardware and software support the feature.
Embedded Video Controller	Enables or disables the Embedded Video Controller . By default, the embedded video controller is Enabled . Current state of Embedded Video Controller is Enabled . Current State of Embedded Video Controller is a read only field, indicating the current state for the Embedded Video Controller. If the Embedded Video Controller is the only display capability in the system (that is, no add-in graphics card is installed), then the Embedded Video Controller is automatically used as the primary display even if the Embedded Video Controller setting is Disabled .
Current State of Embedded Video Controller	Displays the current state of the Embedded Video Controller . Current State of Embedded Video Controller is a read only field, indicating the current state for the Embedded Video Controller.

Menu Item	Description
SR-IOV Global Enable	Enables or disables the BIOS configuration of Single Root I/O Virtualization (SR-IOV) devices. By default, the SR-IOV Global Enable option is set to Disabled .
OS Watchdog Timer	If your system stops responding, this watchdog timer aids in the recovery of your operating system. When this field is set to Enabled , the operating system is allowed to initialize the timer. When the option is set to Disabled (the default), the timer will have no effect on the system.
Memory Mapped I/O above 4 GB	Enables or disables the support for PCIe devices that require large amounts of memory. By default, the option is set to Enabled .
Slot Disablement	Enables or disables the available PCIe slots on your system. The Slot Disablement feature controls the configuration of PCIe cards installed in the specified slot. Slot disablement must be used only when the installed peripheral card is preventing booting into the operating system or causing delays in system startup. If the slot is disabled, both the Option ROM and UEFI driver are disabled.

Serial Communication screen

You can use the **Serial Communication** screen to view the properties of the serial communication port. To view the **Serial Communication** click **System Setup Main Menu** → **System BIOS** → **Serial Communication**.

Menu Item	Description
Serial Communication	Selects serial communication devices (Serial Device 1 and Serial Device 2) in the BIOS. BIOS console redirection can also be enabled and the port address can be specified. By default, Serial Communication option is set to Auto .
Serial Port Address	<p>Enables you to set the port address for serial devices. By default, the Serial Port Address option is set to Serial Device 1=COM2, Serial Device 2=COM1</p> <p> NOTE: You can use only Serial Device 2 for the Serial Over LAN (SOL) feature. To use console redirection by SOL, configure the same port address for console redirection and the serial device.</p> <p> NOTE: Every time the system boots, the BIOS syncs the serial MUX setting saved in iDRAC. The serial MUX setting can independently be changed in iDRAC. Therefore, loading the BIOS default settings from within the BIOS setup utility may not always revert this setting to the default setting of Serial Device 1.</p>
External Serial Connector	<p>You can associate the External Serial Connector to Serial Device 1, Serial Device 2, or the Remote Access Device using this field.</p> <p> NOTE: Only Serial Device 2 can be used for (Serial Over LAN) SOL. To use console redirection by SOL, configure the same port address for console redirection and the serial device.</p>



Menu Item	Description
	 NOTE: Every time the system boots, the BIOS syncs the serial MUX setting saved in iDRAC. The serial MUX setting can independently be changed in iDRAC. Therefore, loading the BIOS default settings from within the BIOS setup utility may not always revert this setting to the default setting of Serial Device 1.
Failsafe Baud Rate	Displays the failsafe baud rate for console redirection. The BIOS attempts to determine the baud rate automatically. This failsafe baud rate is used only if the attempt fails, and the value must not be changed. By default, the Failsafe Baud Rate option is set to 115200 .
Remote Terminal Type	Sets the remote console terminal type. By default, the Remote Terminal Type option is set to VT 100/VT 220 .
Redirection After Boot	Enables or disables the BIOS console redirection when the operating system is loaded. By default, the Redirection After Boot option is set to Enabled .

System Profile Settings screen

You can use the **System Profile Settings** screen to enable specific system performance settings such as power management.

To view the **System Profile Settings** click **System Setup Main Menu** → **System BIOS** → **System Profile Settings**.

Menu Item	Description
System Profile	Sets the system profile. If you set the System Profile option to a mode other than Custom , the BIOS automatically sets the rest of the options. You can only change the rest of the options if the mode is set to Custom . By default, the System Profile option is set to Performance Per Watt Optimized (DAPC) . DAPC is Dell Active Power Controller.  NOTE: The following parameters are available only when the System Profile is set to Custom .
CPU Power Management	Sets the CPU power management. By default, the CPU Power Management option is set to System DBPM (DAPC) . DBPM is Demand-Based Power Management.
Memory Frequency	Sets the speed of the system memory. You can select Maximum Performance , Maximum Reliability , or a specific speed.
Turbo Boost	Enables or disables the processor to operate in turbo boost mode. By default, the Turbo Boost option is set to Enabled .
Energy Efficient Turbo	Enables or disables the Energy Efficient Turbo . Energy Efficient Turbo (EET) is a mode of operation where a processor's core frequency is adjusted within the turbo range based on workload.
C1E	Enables or disables the processor to switch to a minimum performance state when it is idle. By default, the C1E option is set to Enabled .
C States	Enables or disables the processor to operate in all available power states. By default, the C States option is set to Enabled .



Menu Item	Description
Collaborative CPU Performance Control	Enables or disables the CPU power management. When set to Enabled , the CPU power management is controlled by the OS DBPM and the System DBPM (DAPC). By default, the option is set to Disabled .
Memory Patrol Scrub	Sets the memory patrol scrub frequency. By default, the Memory Patrol Scrub option is set to Standard .
Memory Refresh Rate	Sets the memory refresh rate to either 1x or 2x. By default, the Memory Refresh Rate option is set to 1x .
Uncore Frequency	Selects the Processor Uncore Frequency . Dynamic mode allows the processor to optimize power resources across the cores and uncore during runtime. The optimization of the uncore frequency to either save power or optimize performance is influenced by the setting of the Energy Efficiency Policy .
Energy Efficient Policy	Enables you to select the Energy Efficient Policy . The CPU uses the setting to manipulate the internal behavior of the processor and determines whether to target higher performance or better power savings.
Number of Turbo Boost Enabled Cores for Processor 1	 NOTE: If there are two processors installed in the system, you see an entry for Number of Turbo Boost Enabled Cores for Processor 2 . Controls the number of turbo boost enabled cores for processor 1. By default, the maximum number of cores is enabled.
Monitor/Mwait	Enables the Monitor/Mwait instructions in the processor. By default, the Monitor/Mwait option is set to Enabled for all system profiles, except Custom .  NOTE: This option can be disabled only if the C States option in Custom mode is set to disabled .  NOTE: When C States set to Enabled in Custom mode, changing the Monitor/Mwait setting does not impact system power/performance.

System Security Settings screen

You can use the **System Security** screen to perform specific functions such as setting the system password, setup password and disabling the power button.

To view the **System Security** click **System Setup Main Menu** → **System BIOS** → **System Security Settings**.

Menu Item	Description
Intel AES-NI	Improves the speed of applications by performing encryption and decryption using the Advanced Encryption Standard Instruction Set and is set to Enabled by default.
System Password	Sets the system password. This option is set to Enabled by default and is read-only if the password jumper is not installed in the system.
Setup Password	Sets the setup password. This option is read-only if the password jumper is not installed in the system.

Menu Item	Description
Password Status	Locks the system password. By default, the Password Status option is set to Unlocked .
TPM Security	 NOTE: The TPM menu is available only when the TPM module is installed. Allows you to control the reporting mode of the Trusted Platform Module (TPM). By default, the TPM Security option is set to Off . You can only modify the TPM Status, TPM Activation, and Intel TXT fields if the TPM Status field is set to either On with Pre-boot Measurements or On without Pre-boot Measurements .
TPM Information	Changes the operational state of the TPM. By default, the TPM Activation option is set to No Change .
TPM Status	Displays the TPM status.
TPM Command	 CAUTION: Clearing the TPM results in the loss of all keys in the TPM. The loss of TPM keys may affect booting to the operating system. Clears all the contents of the TPM. By default, the TPM Clear option is set to No .
Intel TXT	Enables or disables the Intel Trusted Execution Technology (TXT). To enable Intel TXT , Virtualization Technology must be enabled and TPM Security must be Enabled with Pre-boot measurements. By default, the Intel TXT option is set to Off .
Power Button	Enables or disables the power button on the front of the system. By default, the Power Button option is set to Enabled .
NMI Button	Enables or disables the NMI button on the front of the system. By default, the NMI Button option is set to Disabled .
AC Power Recovery	Sets how the system reacts after AC power is restored to the system. By default, the AC Power Recovery option is set to Last .
AC Power Recovery Delay	Sets how the system supports staggering of power up after AC power is restored to the system. By default, the AC Power Recovery Delay option is set to Immediate .
User Defined Delay (60s to 240s)	Sets the User Defined Delay when the User Defined option for AC Power Recovery Delay is selected.
UEFI Variable Access	Provides varying degrees of securing UEFI variables. When set to Standard (the default) UEFI variables are accessible in the Operating System per the UEFI specification. When set to Controlled , selected UEFI variables are protected in the environment and new UEFI boot entries are forced to be at the end of the current boot order.
Secure Boot	Enables Secure Boot, where the BIOS authenticates each pre-boot image using the certificates in the Secure Boot Policy. Secure Boot is disabled by default.
Secure Boot Policy	When Secure Boot policy is Standard , the BIOS uses the system manufacturer's key and certificates to authenticate pre-boot images. When Secure Boot policy is Custom , the BIOS uses the user-defined key and certificates. Secure Boot policy is Standard by default.

Menu Item	Description
Secure Boot Policy Summary	Displays the list of certificates and hashes that secure boot uses to authenticate images.

Secure Boot Custom Policy Settings screen

Secure Boot Custom Policy Settings is displayed only when **Secure Boot Policy** is set to **Custom**. In the **System Setup Main Menu**, click **System BIOS** → **System Security** → **Secure Boot Custom Policy Settings**.

Menu Item	Description
Platform Key	Imports, exports, deletes, or restores the platform key (PK).
Key Exchange Key Database	Allows you to import, export, delete, or restore entries in the Key Exchange Key (KEK) Database.
Authorized Signature Database	Imports, exports, deletes, or restores entries in the Authorized Signature Database (db).
Forbidden Signature Database	Imports, exports, deletes, or restores entries in the Forbidden Signature Database (dbx).

Miscellaneous Settings screen

You can use the **Miscellaneous Settings** screen to perform specific functions such as updating the asset tag, and changing the system date and time.

To view the **Miscellaneous Settings** screen, click **System Setup Main Menu** → **System BIOS** → **Miscellaneous Settings**.

Menu Item	Description
System Time	Enables you to set the time on the system.
System Date	Enables you to set the date on the system.
Asset Tag	Displays the asset tag and enables you to modify it for security and tracking purposes.
Keyboard NumLock	Enables you to set whether the system boots with the NumLock enabled or disabled. By default the Keyboard NumLock is set to On .  NOTE: This option does not apply to 84-key keyboards.
F1/F2 Prompt on Error	Enables or disables the F1/F2 prompt on error. By default, F1/F2 Prompt on Error is set to Enabled . The F1/F2 prompt also includes keyboard errors.
Load Legacy Video Option ROM	Enables you to determine whether the system BIOS loads the legacy video (INT 10H) option ROM from the video controller. Selecting Enabled in the operating system does not support UEFI video output standards. This field is only for UEFI boot mode. You cannot set this to Enabled if UEFI Secure Boot mode is enabled.

Menu Item	Description
In-System Characterization	<p>This option enables or disables In-System Characterization. By default, In-System Characterization is set to Disabled. The two other options are Enabled and Enabled - No Reboot.</p> <p> NOTE: The default setting for In-System Characterization is subject to change in future BIOS releases.</p> <p>When enabled, In-System Characterization (ISC) executes during POST upon detecting relevant change(s) in system configuration. This helps in optimizing the system power and performance. ISC takes about 20 seconds to execute, and system reset is required for ISC results to be applied. The Enabled - No Reboot option executes ISC and continues without applying ISC results until the next time system reset occurs. The Enabled option executes ISC and forces an immediate system reset so that ISC results can be applied. It takes the system longer to be ready due to the forced system reset. When disabled, ISC does not execute.</p>

About Boot Manager

Boot Manager enables you to add, delete, and arrange boot options. You can also access System Setup and boot options without restarting the system.

Entering Boot Manager

The **Boot Manager** screen enables you to select boot options and diagnostic utilities.

1. Turn on or restart your system.
2. Press F11 when you see the message `F11 = Boot Manager`.
If your operating system begins to load before you press F11, allow the system to finish booting, and then restart your system and try again.

Boot Manager main menu

Menu Item	Description
Continue Normal Boot	The system attempts to boot to devices starting with the first item in the boot order. If the boot attempt fails, the system continues with the next

Menu Item	Description
	item in the boot order until the boot is successful or no more boot options are found.
One Shot Boot Menu	Takes you to the boot menu, where you can select a one time boot device to boot from.
Launch System Setup	Enables you to access System Setup.
Launch Lifecycle Controller	Exits the Boot Manager and invokes the Lifecycle Controller program.
System Utilities	Launches System Utilities menu such as System Diagnostics and UEFI shell.

Changing the boot order

You may have to change the boot order if you want to boot from a USB key or an optical drive. The instructions given below may vary if you have selected **BIOS** for **Boot Mode**.

1. In the **System Setup Main Menu**, click **System BIOS** → **Boot Settings**.
2. Click **Boot Option Settings** → **Boot Sequence**.
3. Use the arrow keys to select a boot device, and use the <+> and <-> keys to move the device down or up in the order.
4. Click **Exit**, click **Yes** to save the settings on exit.

Choosing the system boot mode

System Setup enables you to specify the boot mode for installing your operating system:

- BIOS boot mode (the default) is the standard BIOS-level boot interface.
- Unified Extensible Firmware Interface (UEFI) boot mode is an enhanced 64-bit boot interface. If you have configured your system to boot to UEFI mode, it overlays the system BIOS.

To select the system **Boot Mode**:

1. In **System Setup** click **Boot Settings** and select **Boot Mode**.
2. Select the boot mode you want the system to boot into.

 **NOTE:** After the system boots in the specified boot mode, proceed to install your operating system from that mode.

 **CAUTION:** Trying to boot the operating system from the other boot mode will cause the system to halt at startup.

 **NOTE:** Operating systems must be UEFI-compatible to be installed from the UEFI boot mode. DOS and 32-bit operating systems do not support UEFI and can only be installed from the BIOS boot mode.

 **NOTE:** For the latest information on supported operating systems, go to dell.com/ossupport.

Assigning a system and setup password

Prerequisites

 **NOTE:** The password jumper enables or disables the System Password and Setup Password features. For more information about the password jumper settings, see [System board connectors](#).

You can assign a new **System Password** and **Setup Password** or change an existing **System Password** and **Setup Password** only when the password jumper setting is **enabled** and **Password Status** is **Unlocked**.

If the password jumper setting is disabled, the existing **System Password** and **Setup Password** are deleted and you need not provide the system password to boot the system.

Steps

1. To enter System Setup, press <F2> immediately after a power-on or reboot.
2. From the **System Setup Main Menu**, select **System BIOS** and press <Enter>. The **System BIOS** screen is displayed.
3. On the **System BIOS** screen, select **System Security** and press <Enter>. The **System Security** screen is displayed.
4. On the **System Security** screen, verify that **Password Status** is **Unlocked**.
5. Select **System Password**, enter your system password, and press <Enter> or <Tab>. Use the following guidelines to assign the system password:
 - A password can have up to 32 characters.
 - The password can contain the numbers 0 through 9.
 - Only the following special characters are allowed: space, ("), (+), (.), (-), (.), (/), (:), (I), (\), (l), (').

A message prompts you to re-enter the system password.

6. Re-enter the system password, and click **OK**.
7. Select **Setup Password**, enter your setup password and press <Enter> or <Tab>. A message prompts you to re-enter the setup password.
8. Re-enter the setup password, and click **OK**.
9. Press <Esc> to return to the System BIOS screen. Press <Esc> again. A message prompts you to save the changes.

 **NOTE:** Password protection does not take effect until the system reboots.

Deleting or changing an existing system password or setup password

Prerequisites







Ensure that the Password jumper is set to **enabled** and the **Password Status** is set to **Unlocked** before attempting to delete or change the existing System password or Setup password. You cannot delete or change an existing System password or Setup password if the **Password Status** is set to **Locked**.

Steps

1. To enter System Setup, press **F2** immediately after a power-on or restart.
2. In **System Setup Main Menu**, select **System BIOS** and press **Enter**.
The **System BIOS** screen is displayed.
3. In the **System BIOS** screen, select **System Security** and press **Enter**.
The **System Security** screen is displayed.
4. In the **System Security** screen, verify that **Password Status** is set to **Unlocked**.
5. Select **System Password**, change or delete the existing system password and press **Enter** or **Tab**.
6. Select **Setup Password**, change or delete the existing setup password and press **Enter** or **Tab**.
 **NOTE:** If you change the System password or Setup password, a message prompts you to re-enter the new password. If you delete the System password or Setup password, a message prompts you to confirm the deletion.
7. Press **Esc** to return to the System BIOS screen. Press **Esc** again, and a message prompts you to save the changes and exit.

Installing and removing system components

Safety instructions

-  **WARNING:** Whenever you need to lift the system, get others to assist you. To avoid injury, do not attempt to lift the system by yourself.
-  **WARNING:** Opening or removing the system covers when the system is on may expose you to a risk of electric shock.
-  **CAUTION:** Do not operate the system without the covers. This can cause damage to components.
-  **CAUTION:** Many repairs may only be done by a certified service technician. You should only perform troubleshooting and simple repairs as authorized in your product documentation, or as directed by the online or telephone service and support team. Damage due to servicing that is not authorized by Dell is not covered by your warranty. Read and follow the safety instructions that came with the product.
-  **NOTE:** It is recommended that you always use a static mat and static strap while working on components inside the system.
-  **NOTE:** To ensure proper operation and cooling, all GPU bays in the system must be populated at all times with either a module or with a blank.

Before working inside your system

1. Turn off the system, including any attached peripherals.
2. Disconnect the system from the electrical outlet and disconnect the peripherals.
3. Remove the system from the rack.
4. Remove the system top cover (back).

After working inside your system

1. Install the system top cover (back).
2. Install the system into the rack.
3. Reconnect the peripherals and connect the system to the electrical outlet.

4. Turn the system on, including any attached peripherals.

Recommended tools

You need the following tools to perform the removal and installation procedures:

- Phillips #2 screwdriver
- Phillips #1 screwdriver
- Torx T10 screwdriver
- Torx T6 screwdriver

System covers

Removing the system top cover (front)

Prerequisites



CAUTION: Do not operate the system without the system cover. This can result in overheating and cause component damage.

1. Ensure that you read the [Safety instructions](#).
2. Turn off the system, including any attached peripherals.
3. Disconnect the system from the electrical outlet and disconnect the peripherals.

Steps

1. Turn the system cover lock to the unlocked position.
2. Press the release tabs on the system top cover, and slide the cover toward the front of the system.
3. Hold the cover on both sides, and lift the cover away from the system.

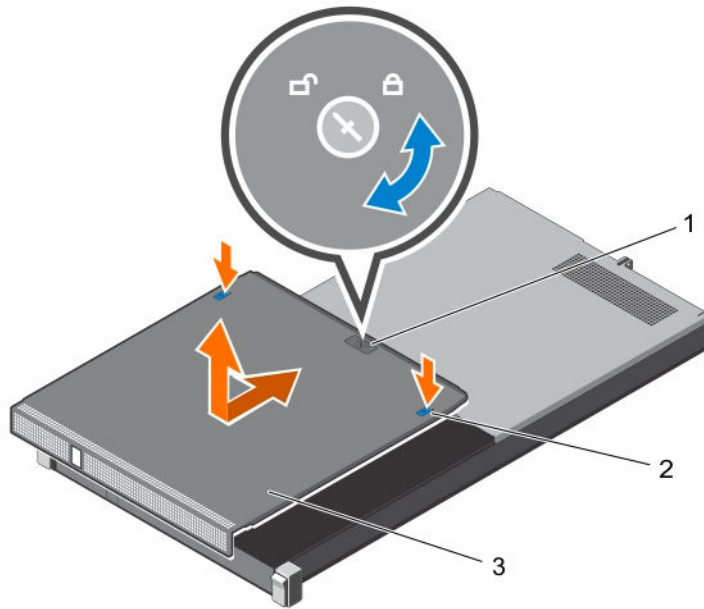

Figure 6. Removing and installing the system top cover (front)

- | | |
|-----------------------------|--------------------|
| 1. system cover lock | 2. release tab (2) |
| 3. system top cover (front) | |

Installing the system top cover (front)

Prerequisites

1. Ensure that you read the [Safety instructions](#).
2. Ensure that all internal cables are connected and routed correctly.

NOTE: Closing the system cover with incorrect cable routing can damage the cables.

Steps

1. Align the slots of the system top cover with the tabs on the chassis.
2. Slide the cover toward the back of the chassis until it locks into place.
3. Turn the system cover lock to the locked position.

Next steps

CAUTION: Turn on the system only when both the system top covers are installed.

Reconnect the system to its electrical outlet and turn the system on, including any attached peripherals.

Removing the system top cover (back)

Prerequisites

CAUTION: Do not operate the system without the system cover. This can result in overheating and cause component damage.

1. Ensure that you read the [Safety instructions](#).
2. Turn off the system, including any attached peripherals.
3. Disconnect the system from the electrical outlet and disconnect the peripherals.
4. Remove the system from the rack.
5. Keep the Phillips #1 screwdriver ready.

Steps

1. Remove the screws securing the system top cover to the chassis.
2. Slide the system top cover toward the back of the system.
3. Hold the cover on both sides, and lift the cover away from the system.

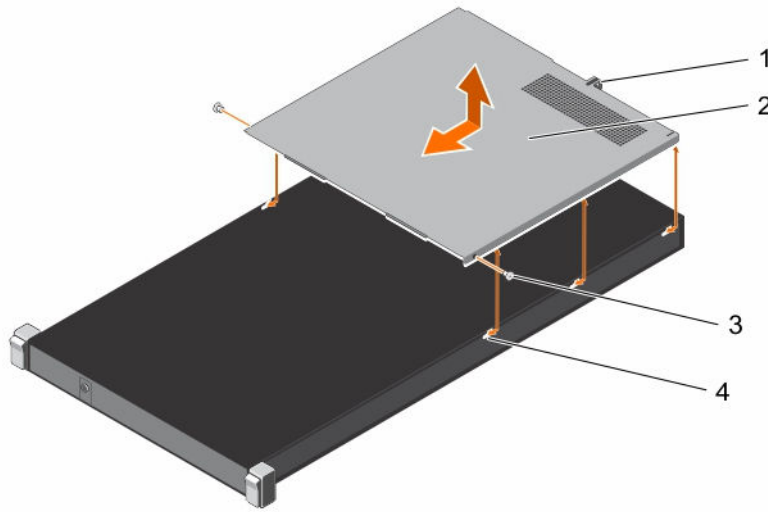



Figure 7. Removing and installing the system top cover (back)

- | | |
|-----------------------------------|----------------------------|
| 1. guide slot on the system cover | 2. system top cover (back) |
| 3. screw (2) | 4. tab on the chassis (6) |

Installing the system top cover (back)

Prerequisites

1. Ensure that you read the [Safety instructions](#).
2. Ensure that all internal cables are connected and routed correctly.
3. Keep the Phillips #1 screwdriver ready.

 **NOTE:** Closing the system cover with incorrect cable routing can damage the cables.

Steps

1. Align the slots of the system top cover with the tabs on the chassis.
2. Align the guide pin on the back of the chassis with the guide slot on the back of the cover.
3. Slide the cover toward the front of the chassis until the guide pin on the back of the chassis locks into the guide slot on the back of the cover.
4. Secure the system top cover to the chassis by using the screws.

Next steps

⚠ CAUTION: Turn on the system only when both the system top covers are installed.

1. Reconnect the system to its electrical outlet and turn the system on, including any attached peripherals.
2. Install the system into the rack.

Inside the system

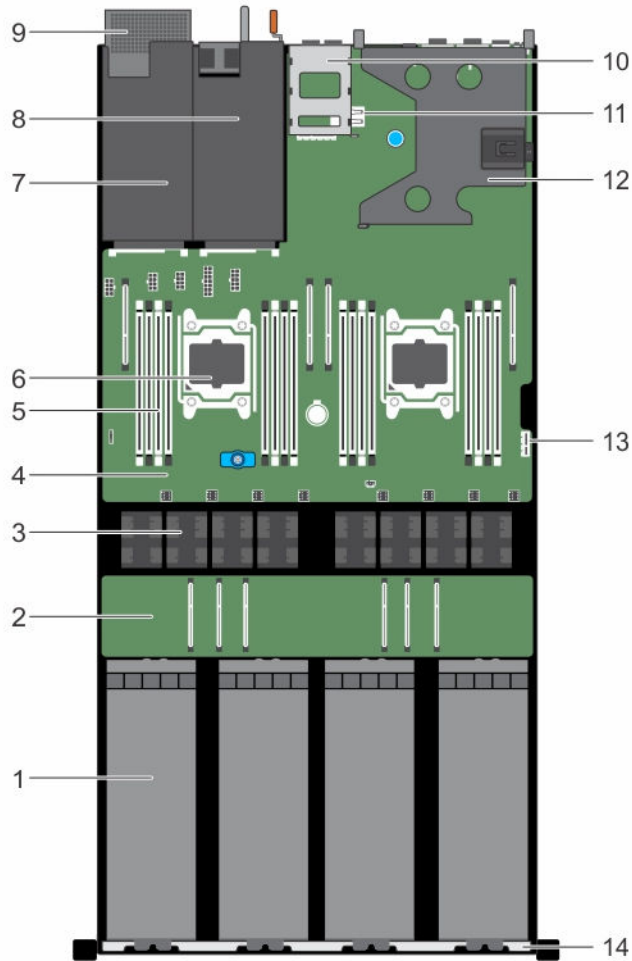

Figure 8. Inside the system—PowerEdge C4130

- | | |
|--|--------------------------------|
| 1. GPU (4) | 2. GPU switch board (optional) |
| 3. cooling fan (8) | 4. system board |
| 5. DIMM (16) | 6. processor (2) |
| 7. power supply unit 2 slot/2.5 inch hard drive slot | 8. power supply unit 1 slot |
| 9. 2.5 inch hard drive cage (optional) | 10. 1.8 inch uSATA SSD cage |

11. internal USB key connector
12. expansion card riser
13. IDSDM connector
14. front inner wall of the chassis

Intrusion switch

Removing the intrusion switch

Prerequisites

 **NOTE:** This is a Field Replaceable Unit (FRU). Removal and installation procedures should be performed only by Dell certified service technicians.

 **CAUTION:** Many repairs may only be done by a certified service technician. You should only perform troubleshooting and simple repairs as authorized in your product documentation, or as directed by the online or telephone service and support team. Damage due to servicing that is not authorized by Dell is not covered by your warranty. Read and follow the safety instructions that came with the product.

1. Ensure that you read the [Safety instructions](#).
2. Follow the procedure listed in [Before working inside your system](#).
3. Ensure that the GPU power and signal cables are do not interfere with the intrusion switch cable.

Steps

1. Disconnect the intrusion switch cable from the connector on the system board.
2. Slide the intrusion switch out of the intrusion switch slot.

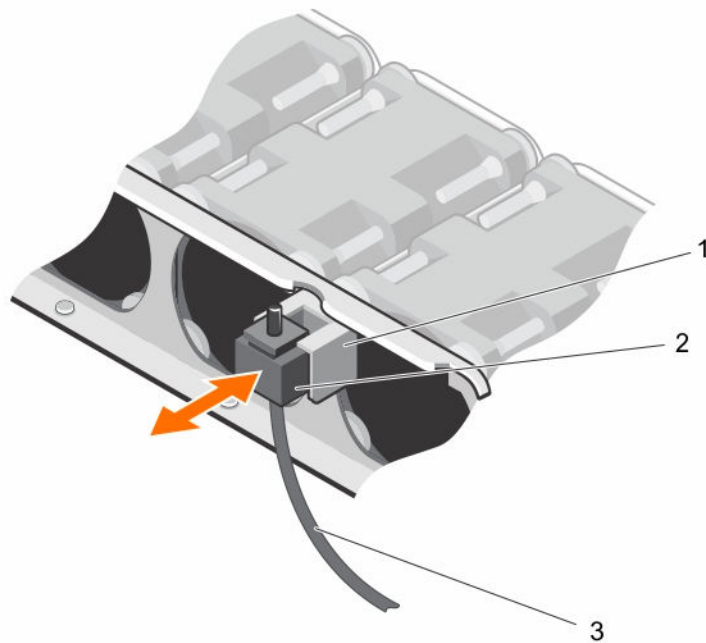

Figure 9. Removing and installing the intrusion switch

1. intrusion switch slot
2. intrusion switch
3. intrusion switch cable

Next steps

Install the intrusion switch.

Related Tasks

[Installing the intrusion switch](#)

Installing the intrusion switch

Prerequisites

-  **NOTE:** This is a Field Replaceable Unit (FRU). Removal and installation procedures should be performed only by Dell certified service technicians.
-  **CAUTION:** Many repairs may only be done by a certified service technician. You should only perform troubleshooting and simple repairs as authorized in your product documentation, or as directed by the online or telephone service and support team. Damage due to servicing that is not authorized by Dell is not covered by your warranty. Read and follow the safety instructions that came with the product.

1. Ensure that you read the [Safety instructions](#).
2. Follow the procedure listed in [Before working inside your system](#).

Steps

1. Slide the intrusion switch into the intrusion switch slot.
2. Connect the intrusion switch cable to the connector on the system board.

Next steps

Follow the procedure listed in [After working inside your system](#).

Related References

[System board connectors](#)

Internal dual SD module (optional)

Removing an internal SD card

Prerequisites

 **CAUTION:** Many repairs may only be done by a certified service technician. You should only perform troubleshooting and simple repairs as authorized in your product documentation, or as directed by the online or telephone service and support team. Damage due to servicing that is not authorized by Dell is not covered by your warranty. Read and follow the safety instructions that came with the product.

 **NOTE:** When the **Redundancy** option is set to **Mirror Mode** in the **Integrated Devices** screen of System Setup, the information is replicated from one SD card to another.

1. Ensure that you read the [Safety instructions](#).
2. Follow the procedure listed in [Before working inside your system](#).

Steps

Locate the SD card slot on the internal dual SD module and press the card to release it from the slot. Temporarily label each SD card with its corresponding slot before removal. Install the SD card(s) into the same slots.

Next steps

Install the SD card.

Installing an internal SD card

Prerequisites

 **CAUTION:** Many repairs may only be done by a certified service technician. You should only perform troubleshooting and simple repairs as authorized in your product documentation, or as directed by the online or telephone service and support team. Damage due to servicing that is not authorized by Dell is not covered by your warranty. Read and follow the safety instructions that came with the product.

1. Ensure that you read the [Safety instructions](#).
2. Follow the procedure listed in [Before working inside your system](#).
3. Ensure that the **Internal SD Card Port** option is enabled in System Setup.

Steps

1. Locate the SD card slot on the internal dual SD module.
 -  **NOTE:** The slot is keyed to ensure correct insertion of the card.
2. Orient the SD card appropriately and insert the contact-pin end of the card into the slot.
3. Press the card into the card slot until it locks into place.

Next steps

Follow the procedure listed in [After working inside your system](#).

Removing the internal dual SD module

Prerequisites

 **CAUTION:** Many repairs may only be done by a certified service technician. You should only perform troubleshooting and simple repairs as authorized in your product documentation, or as directed by the online or telephone service and support team. Damage due to servicing that is not authorized by Dell is not covered by your warranty. Read and follow the safety instructions that came with the product.

1. Ensure that you read the [Safety instructions](#).
2. Follow the procedure listed in [Before working inside your system](#).

Steps

1. Locate the internal dual SD module (IDSDM) on the system board.
2. If installed, remove the SD card(s). For more information, see [Removing an internal SD card](#).
Temporarily label each SD card with its corresponding slot before removal. Install the SD card(s) into the same slots.
3. Hold the pull tab and pull the dual SD module out of the system board.

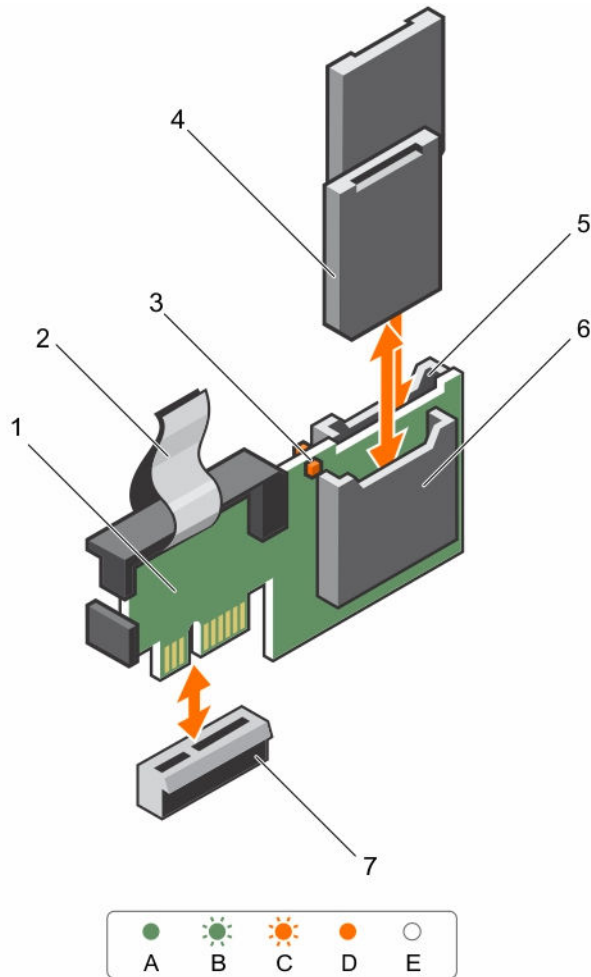

Figure 10. Removing and installing the internal dual SD module (IDSDM)

- | | |
|-----------------------------|-------------------|
| 1. IDSDM | 2. pull tab |
| 3. LED status indicator (2) | 4. SD card (2) |
| 5. SD card slot 2 | 6. SD card slot 1 |
| 7. IDSDM connector | |

The following table describes the IDSDM indicator codes.

Convention	IDSDM indicator code	Condition
A	Green	Indicates that the card is online
B	Flashing green	Indicates rebuild or activity
C	Flashing amber	Indicates card mismatch or that the card has failed
D	Amber	Indicates that the card is offline, has failed, or is write protected

Convention	IDSDM indicator code	Condition
E	Not lit	Indicates that the card is missing or is booting

Next steps

Follow the procedure listed in [After working inside your system](#).

Related References

[System board connectors](#)

Installing the internal dual SD module

Prerequisites



CAUTION: Many repairs may only be done by a certified service technician. You should only perform troubleshooting and simple repairs as authorized in your product documentation, or as directed by the online or telephone service and support team. Damage due to servicing that is not authorized by Dell is not covered by your warranty. Read and follow the safety instructions that came with the product.

1. Ensure that you read the [Safety instructions](#).
2. Follow the procedure listed in [Before working inside your system](#).

Steps

1. Locate the internal dual SD module (IDSDM) connector on the system board.
2. Align the connectors on the system board and the IDSDM.
3. Push the IDSDM until it is firmly seated on the system board.

Next steps

1. Install the SD card(s).
Temporarily label each SD card with its corresponding slot before removal. Replace the SD card(s) into the same slots.
2. Follow the procedure listed in [After working inside your system](#).

Related References

[System board connectors](#)

Related Tasks

[Installing an internal SD card](#)

Cooling shroud

Removing the cooling shroud

Prerequisites

⚠ **CAUTION:** Many repairs may only be done by a certified service technician. You should only perform troubleshooting and simple repairs as authorized in your product documentation, or as directed by the online or telephone service and support team. Damage due to servicing that is not authorized by Dell is not covered by your warranty. Read and follow the safety instructions that came with the product.

⚠ **CAUTION:** Never operate your system with the cooling shroud removed. The system may get overheated quickly, resulting in shutdown of the system and loss of data.

1. Ensure that you read the [Safety instructions](#).
2. Follow the procedure listed in [Before working inside your system](#).

Steps

Lift the cooling shroud away from the chassis.

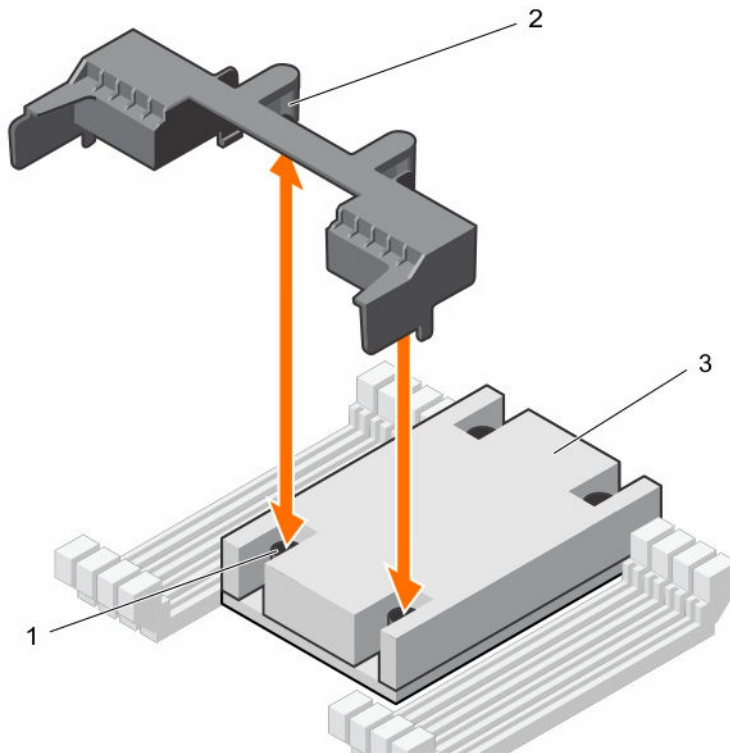

Figure 11. Removing and installing the cooling shroud

1. screw on the heat sink (2)
2. guide slot on the cooling shroud (2)
3. heat sink

Next steps

1. Install the cooling shroud.

Related Tasks

[Installing the cooling shroud](#)

Installing the cooling shroud

Prerequisites

 **CAUTION:** Many repairs may only be done by a certified service technician. You should only perform troubleshooting and simple repairs as authorized in your product documentation, or as directed by the online or telephone service and support team. Damage due to servicing that is not authorized by Dell is not covered by your warranty. Read and follow the safety instructions that came with the product.

1. Ensure that you read the [Safety instructions](#).
2. Ensure that the memory module ejectors are closed.

Steps

1. Align the guide slots on the cooling shroud with the screws on the heat sink.
2. Lower the cooling shroud into the chassis until it is firmly seated.

Next steps

Follow the procedure listed in [After working inside your system](#).

Processor blank

Removing a processor blank

Prerequisites

 **CAUTION:** Many repairs may only be done by a certified service technician. You should only perform troubleshooting and simple repairs as authorized in your product documentation, or as directed by the online or telephone service and support team. Damage due to servicing that is not authorized by Dell is not covered by your warranty. Read and follow the safety instructions that came with the product.

1. Ensure that you read the [Safety instructions](#).
2. Follow the procedure listed in [Before working inside your system](#).

Steps

1. Press the ejectors on both ends of the memory module socket to open it.
2. Hold the processor blank by its edges, and lift it away from the chassis.

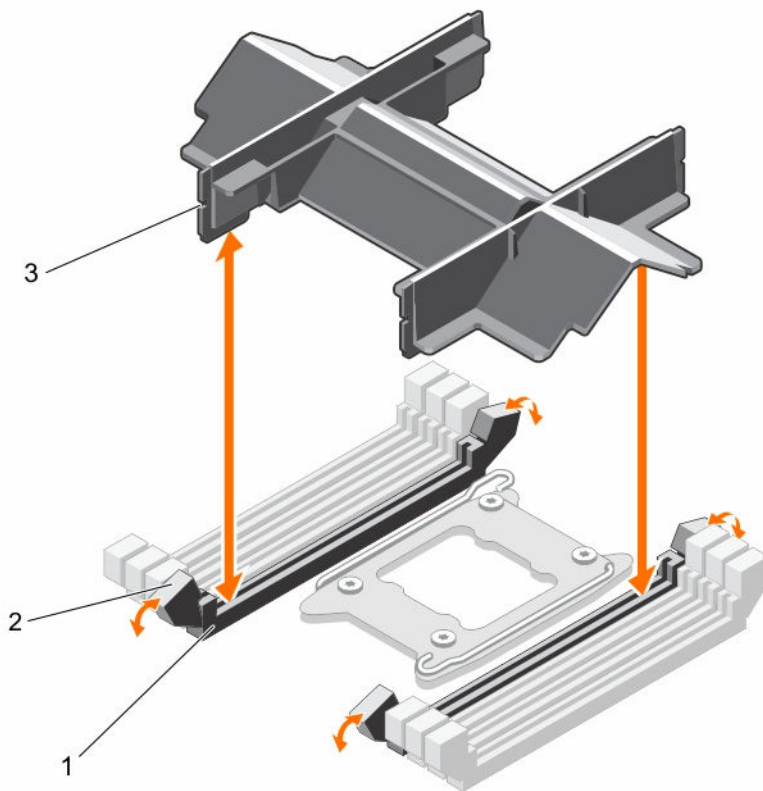

Figure 12. Removing and installing a processor blank

- | | |
|-----------------------------|-------------------------------------|
| 1. memory module socket (2) | 2. memory module socket ejector (2) |
| 3. processor blank | |

Next steps

1. Install the processor.
2. Install the heat sink.
3. Install the memory module(s).
4. Follow the procedure listed in [After working inside your system](#).

Installing a processor blank

If you are converting a dual processor system to a single processor system, install the processor blank.

Prerequisites

⚠ CAUTION: Many repairs may only be done by a certified service technician. You should only perform troubleshooting and simple repairs as authorized in your product documentation, or as directed by the online or telephone service and support team. Damage due to servicing that is not authorized by Dell is not covered by your warranty. Read and follow the safety instructions that came with the product.

1. Ensure that you read the [Safety instructions](#).
2. Follow the procedure listed in [Before working inside your system](#).
3. Ensure that the memory module socket ejectors are in the unlocked position.

Steps

1. Align the processor blank with the memory module socket on the system board.
2. Lower the processor blank into the memory module socket, and press the blank firmly until the memory module socket ejectors click into place.

Next steps

Follow the procedure listed in [After working inside your system](#).

System memory

Your system supports DDR4 registered DIMMs (RDIMMs).

 **NOTE:** MT/s indicates DIMM speed in MegaTransfers per second.

Memory bus operating frequency can be 1333 MT/s, 1600 MT/s, 1866 MT/s, or 2133 MT/s depending on the following factors:

- DIMM type (RDIMM)
- Number of DIMMs populated per channel
- System profile selected (for example, Performance Optimized, Custom, or Dense Configuration Optimized)
- Maximum supported DIMM frequency of the processors

The system contains 16 memory sockets split into two sets of 8 sockets, one set per processor. Each 8-socket set is organized into four channels. In each channel, the release levers of the first socket are marked white and the second socket black.

 **NOTE:** DIMMs in sockets A1 to A8 are assigned to processor 1 and DIMMs in sockets B1 to B8 are assigned to processor 2.

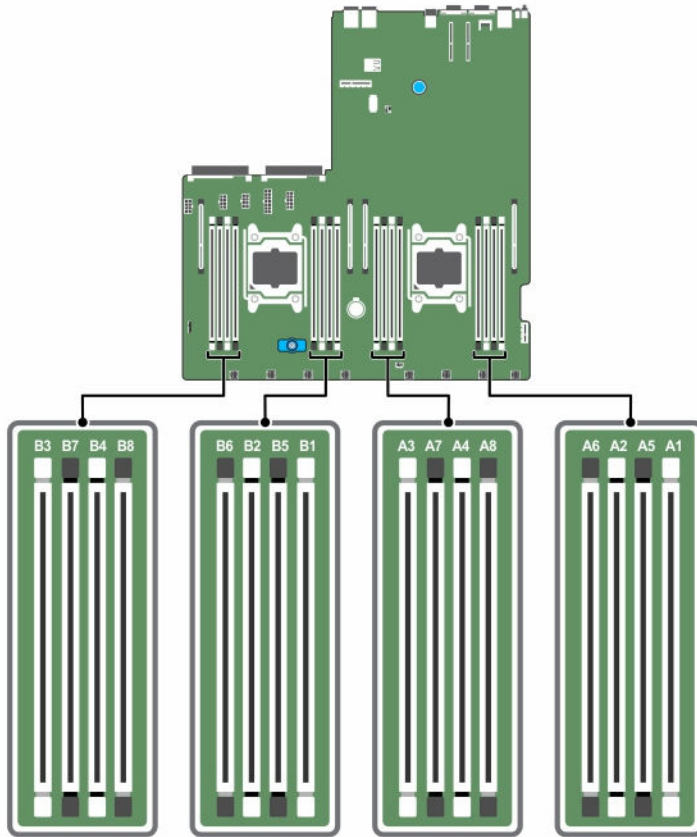

Figure 13. Memory socket locations

Memory channels are organized as follows:

- | | |
|--------------------|--|
| Processor 1 | channel 0: slots A1, A5
channel 1: slots A2, A6
channel 2: slots A3, A7
channel 3: slots A4, A8 |
| Processor 2 | channel 0: slots B1, B5
channel 1: slots B2, B6
channel 2: slots B3, B7
channel 3: slots B4, B8 |

The following table shows the memory populations and operating frequencies for the supported configurations.

DIMM Type	DIMMs Populated/ Channel	Operating Frequency (in MT/s)	Maximum DIMM Rank/Channel
1.2 V			
RDIMM	1	2133, 1866, 1600, 1333	Dual rank or single rank
	2	2133, 1866, 1600, 1333	Dual rank or single rank

General memory module installation guidelines

This system supports flexible memory configuration, enabling the system to be configured and run in any valid chipset architectural configuration. The following are the recommended guidelines for installing memory modules:

- x4 and x8 DRAM based memory modules can be mixed. For more information, see [Mode-specific guidelines](#).
- Up to two dual- or single-rank RDIMMs can be populated per channel.
- Populate memory module sockets only if a processor is installed. For single-processor systems, sockets A1 to A8 are available. For dual-processor systems, sockets A1 to A8 and sockets B1 to B8 are available.
- Populate all sockets with white release tabs first and then the black release tabs.
- Populate the sockets by the highest rank count, in the following order—first in sockets with white release tabs and then with the black release tabs. For example, if you want to mix single-rank and dual-rank memory modules, populate dual-rank memory modules in the sockets with white release tabs and single-rank memory modules in the sockets with black release tabs.
- When mixing memory modules with different capacities, populate the sockets with memory modules with the highest capacity first. For example, if you want to mix 4 GB and 8 GB memory modules, populate 8 GB memory modules in the sockets with white release tabs and 4 GB memory modules in the sockets with black release tabs.
- In a dual-processor configuration, the memory configuration for each processor should be identical. For example, if you populate socket A1 for processor 1, then populate socket B1 for processor 2, and so on.
- Memory modules of different capacities can be mixed provided other memory population rules are followed (for example, 4 GB and 8 GB memory modules can be mixed).
- Mixing of more than two memory module capacities in a system is not supported.
- Populate two memory modules per processor (one memory module per channel) at a time to maximize performance.

Mode-specific guidelines

Four memory channels are allocated to each processor. The allowable configurations depend on the memory mode selected.

-  **NOTE:** You can mix x4 and x8 DRAM based DIMMs to support RAS features. However, all guidelines for specific RAS features must be followed. x4 DRAM based DIMMs retain Single Device Data Correction (SDDC) in memory optimized (independent channel) mode. x8 DRAM based DIMMs require Advanced ECC mode to gain SDDC.

The following sections provide additional slot population guidelines for each mode:

Advanced ECC (lockstep)

Advanced ECC mode extends SDDC from x4 DRAM based DIMMs to both x4 and x8 DRAMs. This protects against single DRAM chip failures during normal operation.

The installation guidelines for memory modules are as follows:

- Memory modules must be identical in size, speed, and technology.
- DIMMs installed in memory sockets with white release levers must be identical and the same rule applies for sockets with black release levers. This ensures that identical DIMMs are installed in matched pair—for example, A1 with A2, A3 with A4, A5 with A6, and so on.

 **NOTE:** Advanced ECC with mirroring is not supported.

Memory optimized (independent channel) mode

This mode supports SDDC only for memory modules that use x4 device width, and this mode does not impose any specific slot population requirements.

Memory sparing

 **NOTE:** To use memory sparing, this feature must be enabled in System Setup.

In this mode, one rank per channel is reserved as a spare. If persistent correctable errors are detected on a rank, the data from this rank is copied to the spare rank, and the failed rank is disabled.

With memory sparing enabled, the system memory available to the operating system is reduced by one rank per channel. For example, in a dual-processor configuration with sixteen 4 GB dual-rank memory modules, the available system memory is: $3/4$ (ranks/channel) \times 16 (memory modules) \times 4 GB = 48 GB, and not 16 (memory modules) \times 4 GB = 64 GB.

 **NOTE:** Memory sparing does not offer protection against a multi-bit uncorrectable error.

 **NOTE:** Both Advanced ECC/Lockstep and Optimizer modes support memory sparing.

Memory mirroring

Memory mirroring offers the strongest memory module reliability mode compared to all other modes, providing improved uncorrectable multi-bit failure protection. In a mirrored configuration, the total available system memory is one half of the total installed physical memory. Half of the installed memory is used to mirror the active memory modules. In the event of an uncorrectable error, the system switches over to the mirrored copy. This ensures SDDC and multi-bit protection.

The installation guidelines for memory modules are as follows

- Memory modules must be identical in size, speed, and technology.
- Memory modules installed in memory module sockets with white release levers must be identical and the same rule applies for sockets with black and green release tabs. This ensures that identical memory modules are installed in matched pairs—for example, A1 with A2, A3 with A4, A5 with A6, and so on.

Sample memory configurations

The following tables show sample memory configurations for single and dual processor configurations that follow the appropriate memory guidelines.

 **NOTE:** 1R, 2R, and 4R in the following tables indicate single-, dual-, and quad-rank memory modules respectively.

Table 2. Memory configurations—single processor

System capacity (in GB)	Memory modules size (in GB)	Number of memory modules	Memory module rank, organization, and frequency	Memory module slot population
4	4	1	1R, x8, 2133 MT/s,	A1
			1R, x8, 1866 MT/s	
8	4	2	1R, x8, 2133 MT/s,	A1, A2
			1R, x8, 1866 MT/s	
16	4	4	1R, x8, 2133 MT/s,	A1, A2, A3, A4
			1R, x8, 1866 MT/s	
	8	2	2R, x8, 2133 MT/s,	A1, A2
			2R, x8, 1866 MT/s	
24	4	6	1R, x8, 2133 MT/s,	A1, A2, A3, A4, A5, A6
			1R, x8, 1866 MT/s	
32	8	4	2R, x8, 2133 MT/s,	A1, A2, A3, A4
			2R, x8, 1866 MT/s	
	16	2	2R, x8, 2133 MT/s,	A1, A2
			2R, x8, 1866 MT/s	
	32	1	2R, x8, 2133 MT/s,	A1
			2R, x8, 1866 MT/s	
48	8	6	2R, x8, 2133 MT/s,	A1, A2, A3, A4, A5, A6
			2R, x8, 1866 MT/s	
64	8	8	2R, x8, 2133 MT/s,	A1, A2, A3, A4, A5, A6, A7, A8
			2R, x8, 1866 MT/s	

System capacity (in GB)	Memory modules size (in GB)	Number of memory modules	Memory module rank, organization, and frequency	Memory module slot population
	16	4	2R, x8, 2133 MT/s, 2R, x8, 1866 MT/s	A1, A2, A3, A4
	32	2	2R, x8, 2133 MT/s, 2R, x8, 1866 MT/s	A1, A2
96	16	6	2R, x4, 2133 MT/s, 2R, x4, 1866 MT/s	A1, A2, A3, A4, A5, A6
128	16	8	2R, x4, 2133 MT/s, 2R, x4, 1866 MT/s,	A1, A2, A3, A4, A5, A6, A7, A8
	32	4	2R, x4, 2133 MT/s, 2R, x4, 1866 MT/s,	A1, A2, A3, A4
192	32	6	2R, x4, 2133 MT/s, 2R, x4, 1866 MT/s	A1, A2, A3, A4, A5, A6
256	32	8	2R, x4, 2133 MT/s, 2R, x4, 1866 MT/s	A1, A2, A3, A4, A5, A6, A7, A8

Table 3. Memory configurations—dual processors

System capacity (in GB)	Memory modules size (in GB)	Number of memory modules	Memory module rank, organization, and frequency	Memory module slot population
8	4	2	1R, x8, 2133 MT/s, 1R, x8, 1866 MT/s	A1, B1
16	4	4	1R, x8, 2133 MT/s, 1R, x8, 1866 MT/s	A1, A2, B1, B2
32	4	8	1R, x8, 2133 MT/s, 1R, x8, 1866 MT/s	A1, A2, A3, A4, B1, B2, B3, B4
64	4	16	1R, x8, 2133 MT/s, 1R, x8, 1866 MT/s	A1, A2, A3, A4, A5, A6, A7, A8, B1, B2, B3, B4, B5, B6, B7, B8
	8	8	2R, x8, 2133 MT/s,	A1, A2, A3, A4, B1, B2, B3, B4

System capacity (in GB)	Memory modules size (in GB)	Number of memory modules	Memory module rank, organization, and frequency	Memory module slot population
			2R, x8, 1866 MT/s	
	16	4	1R, x8, 2133 MT/s, 1R, x8, 1866 MT/s	A1, A2, B1, B2
	32	2	1R, x8, 2133 MT/s, 1R, x8, 1866 MT/s	A1, B1
96	8	12	2R, x8, 2133 MT/s, 2R, x8, 1866 MT/s	A1, A2, A3, A4, A5, A6, B1, B2, B3, B4, B5, B6
128	8	16	2R, x8, 2133 MT/s, 2R, x8, 1866 MT/s	A1, A2, A3, A4, A5, A6, A7, A8, B1, B2, B3, B4, B5, B6, B7, B8
	16	8	2R, x4, 2133 MT/s, 2R, x4, 1866 MT/s	A1, A2, A3, A4, B1, B2, B3, B4
	32	4	1R, x8, 2133 MT/s, 1R, x8, 1866 MT/s	A1, A2, B1, B2
160	16 and 8	12	2R, x4, 2133 MT/s, 2R, x8, 2133 MT/s, 2R, x4, 1866 MT/s, 2R, x8, 1866 MT/s	A1, A2, A3, A4, A5, A6, B1, B2, B3, B4, B5, B6
				 NOTE: 16 GB memory modules must be installed in slots numbered A1, A2, A3, A4, B1, B2, B3, and B4 and 8 GB memory modules must be installed in slots A5, A6, B5, and B6.
192	16	12	2R, x4, 2133 MT/s, 2R, x4, 1866 MT/s	A1, A2, A3, A4, A5, A6, B1, B2, B3, B4, B5, B6
256	16	16	2R, x4, 2133 MT/s, 2R, x4, 1866 MT/s,	A1, A2, A3, A4, A5, A6, A7, A8, B1, B2, B3, B4, B5, B6, B7, B8
	32	8	2R, x4, 2133 MT/s, 2R, x4, 1866 MT/s	A1, A2, A3, A4, B1, B2, B3, B4
384	32	12	2R, x4, 2133 MT/s	A1, A2, A3, A4, A5, A6, B1, B2, B3, B4, B5, B6

System capacity (in GB)	Memory modules size (in GB)	Number of memory modules	Memory module rank, organization, and frequency	Memory module slot population
512	32	16	2R, x4, 2133 MT/s	A1, A2, A3, A4, A5, A6, A7, A8, B1, B2, B3, B4, B5, B6, B7, B8

Removing memory modules

Prerequisites

 **CAUTION:** Many repairs may only be done by a certified service technician. You should only perform troubleshooting and simple repairs as authorized in your product documentation, or as directed by the online or telephone service and support team. Damage due to servicing that is not authorized by Dell is not covered by your warranty. Read and follow the safety instructions that came with the product.

1. Ensure that you read the [Safety instructions](#).
2. Follow the procedure listed in [Before working inside your system](#).
3. Remove the cooling shroud. For more information, see [Removing the cooling shroud](#).

 **WARNING:** The memory modules are hot to touch for some time after the system has been powered down. Allow the memory modules to cool before handling them. Handle the memory modules by the card edges and avoid touching the components or metallic contacts on the memory module.

 **CAUTION:** To ensure proper system cooling, memory module blanks must be installed in any memory socket that is not occupied. Remove memory module blanks only if you intend to install memory modules in those sockets.

Steps

1. Locate the appropriate memory module socket.
2. To release the memory module from the socket, simultaneously press the ejectors on both ends of the memory module socket.

 **CAUTION:** Handle each memory module only by the card edges, making sure not to touch the middle of the memory module or metallic contacts.

3. Lift the memory module away from the chassis.

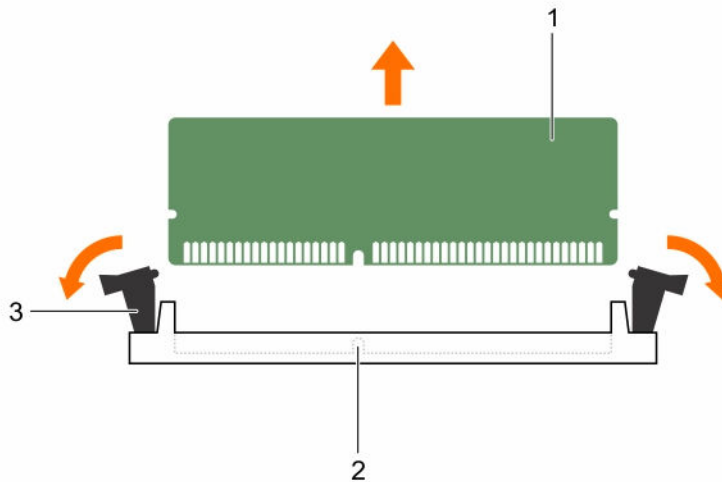



Figure 14. Removing and installing a memory module

- | | |
|-------------------------------------|-------------------------|
| 1. memory module | 2. memory module socket |
| 3. memory module socket ejector (2) | |

Next steps

1. Install the memory module, if applicable.
2. If you are removing a memory module permanently, install a memory module blank.
 -  **NOTE:** The procedure to install a memory module blank is similar to the procedure to install a memory module.
3. Install the cooling shroud.

Related Tasks

- [Installing memory modules](#)
- [Installing the cooling shroud](#)

Installing memory modules

Prerequisites

 **CAUTION:** Many repairs may only be done by a certified service technician. You should only perform troubleshooting and simple repairs as authorized in your product documentation, or as directed by the online or telephone service and support team. Damage due to servicing that is not authorized by Dell is not covered by your warranty. Read and follow the safety instructions that came with the product.

1. Ensure that you read the [Safety instructions](#).
2. Follow the procedure listed in [Before working inside your system](#).
3. Remove the cooling shroud. For more information, see [Removing the cooling shroud](#).

 **WARNING:** The memory modules are hot to touch for some time after the system has been powered down. Allow the memory modules to cool before handling them. Handle the memory modules by the card edges and avoid touching the components or metallic contacts on the memory module.

 **CAUTION:** To ensure proper system cooling, memory module blanks must be installed in any memory socket that is not occupied. Remove memory module blanks only if you intend to install memory modules in those sockets.

Steps

1. Locate the appropriate memory module socket.

 **CAUTION:** Handle each memory module only by the card edges, making sure not to touch the middle of the memory module or metallic contacts.

2. If a memory module or a memory module blank is installed in the socket, remove it.

 **NOTE:** The procedure to remove a memory module blank is similar to the procedure to remove a memory module.

 **NOTE:** Retain the removed memory module blank(s) for future use.

 **CAUTION:** To prevent damage to the memory module or the memory module socket during installation, do not bend or flex the memory module; insert both ends of the memory module simultaneously.

3. Align the edge connector of the memory module with the alignment key of the memory module socket, and insert the memory module in the socket.

 **NOTE:** The memory module socket has an alignment key that allows you to install the memory module in the socket in only one orientation.

 **CAUTION:** Do not apply pressure at the center of the memory module; apply pressure at both ends of the memory module evenly.

4. Press the memory module with your thumbs until the socket levers firmly click into place.

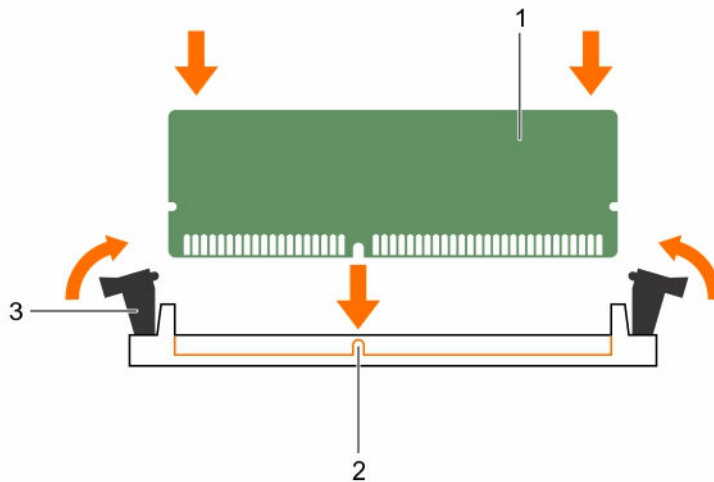

Figure 15. Installing the memory module

- | | |
|-------------------------------------|------------------|
| 1. memory module | 2. alignment key |
| 3. memory module socket ejector (2) | |

Next steps

1. Install the cooling shroud.
2. Follow the procedure listed in [After working inside your system.](#)
3. Press <F2> to enter System Setup, and check the **System Memory** setting. The **System Memory Size** should reflect the installed memory.
4. If the **System Memory Size** is incorrect, one or more of the memory modules may not be installed properly. Ensure that the memory modules are firmly seated in their sockets.
5. Run the system memory test in system diagnostics.

Related Tasks

[Installing the cooling shroud](#)

Processors

Use the following procedures when:

- Installing an additional processor
- Replacing a processor

 **NOTE:** To ensure proper system cooling, you must install a processor blank in any empty processor socket.

Removing a heat sink

Prerequisites

 **CAUTION:** Many repairs may only be done by a certified service technician. You should only perform troubleshooting and simple repairs as authorized in your product documentation, or as directed by the online or telephone service and support team. Damage due to servicing that is not authorized by Dell is not covered by your warranty. Read and follow the safety instructions that came with the product.

 **CAUTION:** Never remove the heat sink from a processor unless you intend to remove the processor. The heat sink is necessary to maintain proper thermal conditions.

 **NOTE:** To ensure proper system cooling, you must install a processor blank in any empty processor socket.

1. Ensure that you read the [Safety instructions](#).
2. Keep the Phillips #2 screwdriver ready.
3. Follow the procedure listed in [Before working inside your system](#).
4. Remove the cooling shroud. For more information, see [Removing the cooling shroud](#).

 **WARNING:** The heat sink will be hot to touch for some time after the system has been powered down. Allow the heat sink to cool before removing it.

Steps

1. Loosen one of the screws that secure the heat sink to the system board.
Wait 30 seconds for the heat sink to loosen from the processor.
2. Remove the screw diagonally opposite the screw you first removed.
3. Repeat the procedure for the remaining two screws.

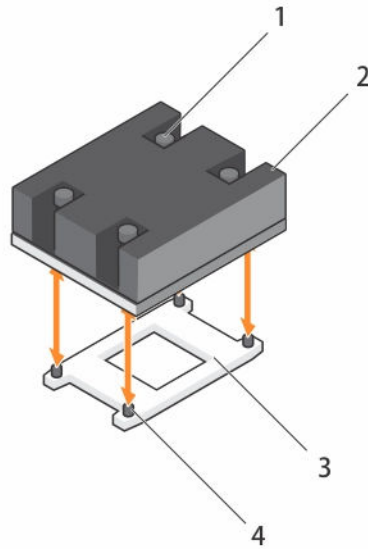

Figure 16. Removing and installing a heat sink

- | | |
|----------------------|-------------------|
| 1. captive screw (4) | 2. heat sink |
| 3. processor socket | 4. screw hole (4) |

Next steps

1. Remove the processor.

Related Tasks

[Removing a processor](#)

Removing a processor

Prerequisites

CAUTION: Many repairs may only be done by a certified service technician. You should only perform troubleshooting and simple repairs as authorized in your product documentation, or as directed by the online or telephone service and support team. Damage due to servicing that is not authorized by Dell is not covered by your warranty. Read and follow the safety instructions that came with the product.

NOTE: To ensure proper system cooling, you must install a processor blank in any empty processor socket.

1. Ensure that you read the [Safety instructions](#).
2. Keep the Phillips #2 screwdriver ready.
3. If you are upgrading your system (from a single processor system to a dual processor system or a processor with a higher processor bin), download the latest system BIOS version from [dell.com/support](#) and follow the instructions included in the compressed download file to install the update on your system.



 **NOTE:** You can update the system BIOS by using Lifecycle Controller.

4. Follow the procedure listed in [Before working inside your system](#).
5. Remove the cooling shroud. For more information, see [Removing the cooling shroud](#).
6. Remove the heat sink. For more information, see [Removing a heat sink](#)

 **WARNING:** The processor will be hot to touch for some time after the system has been powered down. Allow the processor to cool before removing it.

 **CAUTION:** The processor is held in its socket under strong pressure. Be aware that the release lever can spring up suddenly if not firmly grasped.

Steps

1. Release the *open first* socket release lever near the unlock icon  by pushing the lever down and out from under the tab.
2. Release the *close first* socket release lever near the lock icon  by pushing the lever down and out from under the tab. Lift the lever 90 degrees upward.
3. Lower the *open first* socket release lever to lift the processor shield.
4. Hold the tab on the processor shield and lift the processor shield until the *open first* socket release lever lifts up.

 **CAUTION:** The socket pins are fragile and can be permanently damaged. Be careful not to bend the pins in the socket when removing the processor out of the socket.

5. Lift the processor out of the socket and leave the *open first* socket release lever up.

 **NOTE:** If you are permanently removing the processor, you must install a socket protective cap in the vacant socket to protect the socket pins and keep the socket free of dust.

 **NOTE:** After removing the processor, place it in an anti-static container for reuse, return, or temporary storage. Do not touch the bottom of the processor. Touch only the side edges of the processor.

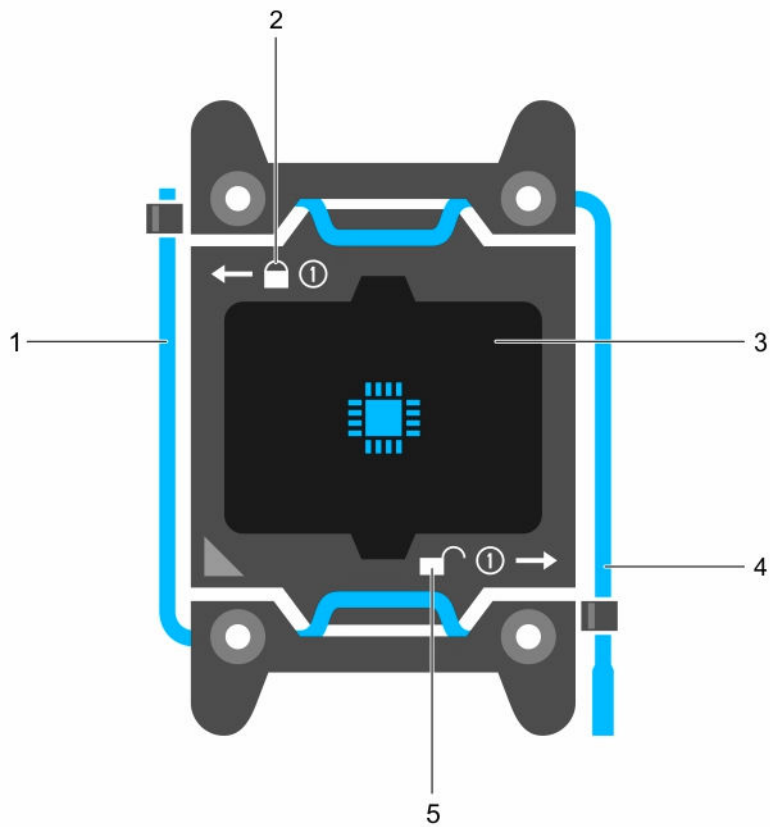

Figure 17. Processor shield

- | | |
|--|---|
| 1. <i>close first</i> socket release lever | 2. lock icon |
| 3. processor | 4. <i>open first</i> socket release lever |
| 5. unlock icon | |

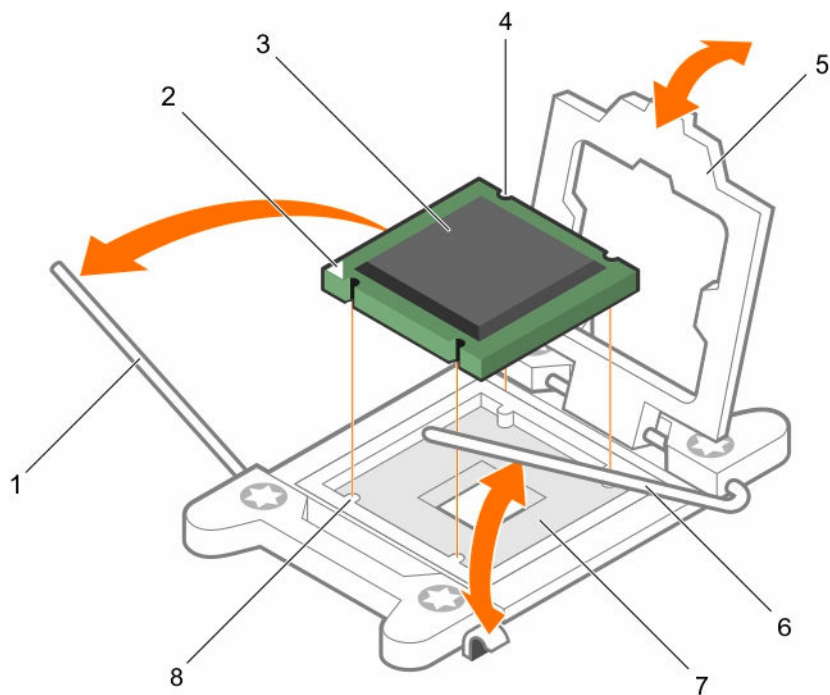

Figure 18. Removing and installing a processor

- | | |
|-------------------------------------|------------------------------------|
| 1. close first socket release lever | 2. pin-1 indicator of processor |
| 3. processor | 4. slot (4) |
| 5. processor shield | 6. open first socket release lever |
| 7. socket | 8. socket keys (4) |

Next steps

1. Install the processor.
2. Install the heat sink.
3. Follow the procedure listed in [After working inside your system.](#)

Related Tasks

- [Installing a processor](#)
- [Installing a heat sink](#)

Installing a processor

Prerequisites

 **CAUTION:** Many repairs may only be done by a certified service technician. You should only perform troubleshooting and simple repairs as authorized in your product documentation, or as directed by the online or telephone service and support team. Damage due to servicing that is not authorized by Dell is not covered by your warranty. Read and follow the safety instructions that came with the product.



1. Ensure that you read the [Safety instructions](#).
2. Keep the Phillips #2 screwdriver ready.
3. If you are upgrading your system (from a single processor system to a dual processor system or a processor with a higher processor bin) download the latest system BIOS version from [dell.com/support](#) and follow the instructions included in the compressed download file to install the update on your system.

 **NOTE:** You can update the system BIOS by using Lifecycle Controller.

4. Follow the procedure listed in [Before working inside your system](#).
5. Remove the processor blank. For more information, see [Removing a processor blank](#).

 **NOTE:** If you are installing a single processor, it must be installed in socket CPU 1.

Steps

1. Unpack the new processor.
2. Locate the processor socket.
3. If applicable, remove the socket protective cap.
4. Release the *open first* socket release lever near the unlock icon  by pushing the lever down and out from under the tab.
5. Release the *close first* socket release lever near the lock icon  by pushing the lever down and out from under the tab. Lift the lever 90 degrees upward.
6. Hold the tab near the lock symbol on the processor shield and lift it up and out of the way.

 **CAUTION:** Positioning the processor incorrectly can permanently damage the system board or the processor. Be careful not to bend the pins in the socket.

 **CAUTION:** While removing or reinstalling the processor, wipe your hands of any contaminants. Contaminants on the processor pins such as thermal grease or oil can damage the processor.

7. Align the processor with the socket keys.

 **CAUTION:** Do not use force to seat the processor. When the processor is positioned correctly, it engages easily into the socket.

8. Align the pin-1 indicator of the processor with the triangle on the socket.
9. Place the processor on the socket such that the slots on the processor align with the socket keys.

 **CAUTION:** Do not use force to seat the processor. When the processor is positioned correctly, it engages easily into the socket.

10. Close the processor shield.
11. Lower the *close first* socket release lever near the lock icon  and push it under the tab to lock it.

12. Lower the *open first* socket release lever near the unlock icon  and push it under the tab to lock it.

Next steps

 **NOTE:** Ensure that you install the heat sink after you install the processor. The heat sink is necessary to maintain proper thermal conditions.

1. Install the heat sink.
2. Follow the procedure listed in [After working inside your system](#).

Related Tasks

[Installing a heat sink](#)

Installing a heat sink

Prerequisites

 **CAUTION:** Many repairs may only be done by a certified service technician. You should only perform troubleshooting and simple repairs as authorized in your product documentation, or as directed by the online or telephone service and support team. Damage due to servicing that is not authorized by Dell is not covered by your warranty. Read and follow the safety instructions that came with the product.

1. Ensure that you read the [Safety instructions](#).
2. Keep the Phillips #2 screwdriver ready.
3. Install the processor. See [Installing a processor](#).
4. Follow the procedure listed in [Before working inside your system](#).

 **NOTE:** If you are installing a single processor, it must be installed in socket CPU 1.

Steps

1. If you are using an existing heat sink, remove the thermal grease from the heat sink by using a clean lint-free cloth.
2. Use the thermal grease syringe included with your processor kit to apply the grease in a thin spiral on the top of the processor as shown in the following figure.

 **CAUTION:** Applying too much thermal grease can result in excess grease coming in contact with and contaminating the processor socket.

 **NOTE:** The thermal grease syringe is intended for one-time use only. Dispose of the syringe after you use it.

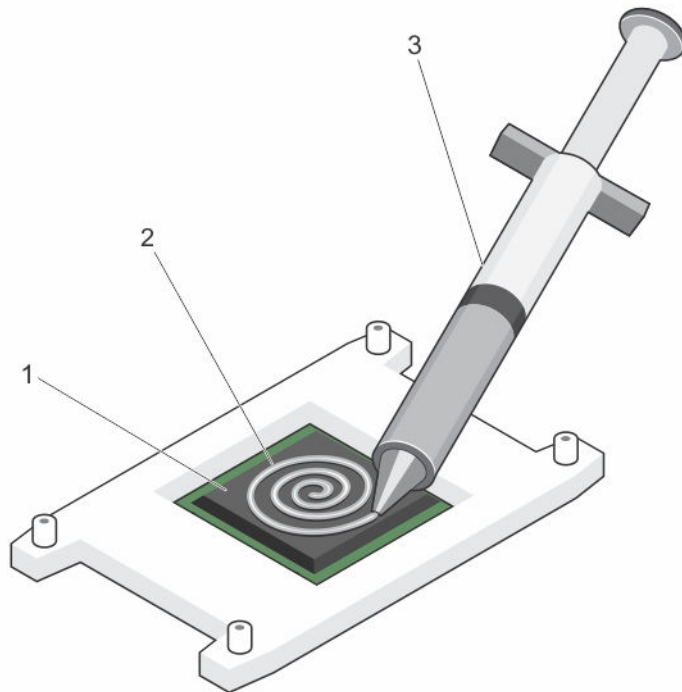

Figure 19. Applying thermal grease on the top of the processor

1. processor
 2. thermal grease
 3. thermal grease syringe
3. Place the heat sink onto the processor.
 4. Tighten one of the four screws to secure the heat sink to the system board.
 5. Tighten the screw diagonally opposite to the first screw you tightened.
NOTE: Do not over-tighten the heat sink retention screws when installing the heat sink. To prevent over-tightening, tighten the retention screw until resistance is felt, and stop once the screw is seated. The screw tension should be no more than 6 in-lb (6.9 cm-kg).
 6. Repeat the procedure for the remaining two screws.

Next steps

1. Install the cooling shroud.
2. Follow the procedure listed in [After working inside your system](#).
3. While booting, press <F2> to enter System Setup and check that the processor information matches the new system configuration.
4. Run system diagnostics to verify that the new processor operates correctly.



Related Tasks

[Installing the cooling shroud](#)

System battery

Replacing the system battery

Prerequisites

-  **NOTE:** This is a Field Replaceable Unit (FRU). Removal and installation procedures should be performed only by Dell certified service technicians.
 -  **WARNING:** There is a danger of a new battery exploding if it is incorrectly installed. Replace the battery only with the same or equivalent type recommended by the manufacturer. For more information, see the safety information that shipped with your system.
 -  **CAUTION:** Many repairs may only be done by a certified service technician. You should only perform troubleshooting and simple repairs as authorized in your product documentation, or as directed by the online or telephone service and support team. Damage due to servicing that is not authorized by Dell is not covered by your warranty. Read and follow the safety instructions that came with the product.
1. Ensure that you read the [Safety instructions](#).
 2. Follow the procedure listed in [Before working inside your system](#).
 3. Disconnect the GPU signal and power cables from the system board.

Steps

1. Locate the battery socket.
 -  **CAUTION:** To avoid damage to the battery connector, you must firmly support the connector while installing or removing a battery.
2. Place your finger between the securing tabs at the negative side of the battery connector, and lift the battery out of the socket.

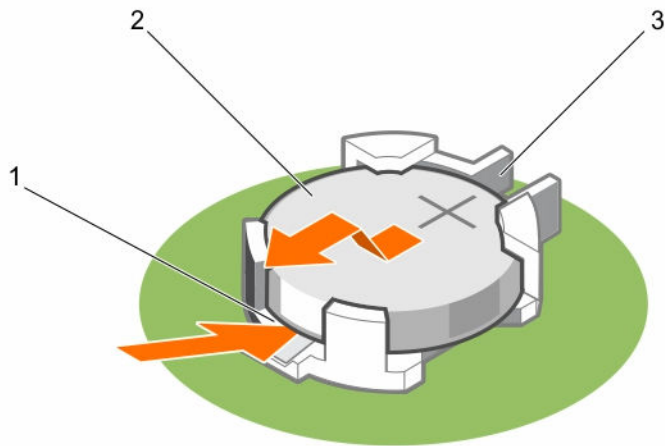

Figure 20. Removing the system battery

1. negative side of the battery connector
2. system battery
3. positive side of the battery connector
3. To install a new system battery, hold the battery with the "+" sign facing up and slide it under the securing tabs at the positive side of the connector.
4. Press the battery into the connector until it locks into place.

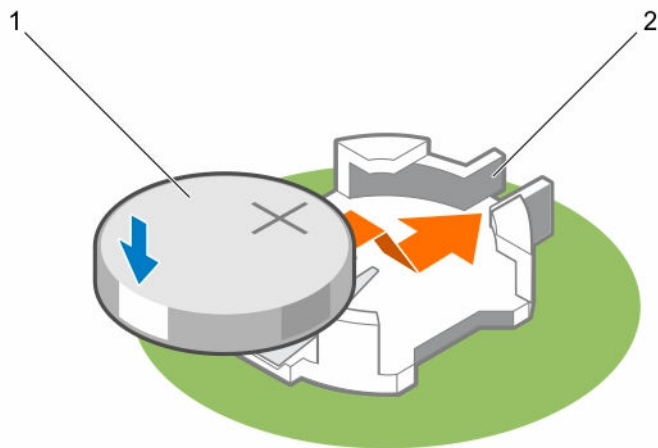

Figure 21. Installing the system battery

1. system battery
2. positive side of the battery connector

Next steps

1. Connect the GPU signal and power cables to the system board.
2. Follow the procedure listed in [After working inside your system](#).
3. While booting, press <F2> to enter System Setup and ensure that the battery is operating properly.
4. Enter the correct time and date in the System Setup **Time** and **Date** fields.
5. Exit System Setup.

Related References

[System board connectors](#)

Related Tasks

[Installing a GPU riser cable on the system board](#)

[Installing a processor blank](#)

PCIe shroud

Removing the PCIe shroud

Prerequisites



CAUTION: Many repairs may only be done by a certified service technician. You should only perform troubleshooting and simple repairs as authorized in your product documentation, or as directed by the online or telephone service and support team. Damage due to servicing that is not authorized by Dell is not covered by your warranty. Read and follow the safety instructions that came with the product.

1. Ensure that you read the [Safety instructions](#).
2. Follow the procedure listed in [Before working inside your system](#).

Steps

Lift the PCIe shroud away from the system.

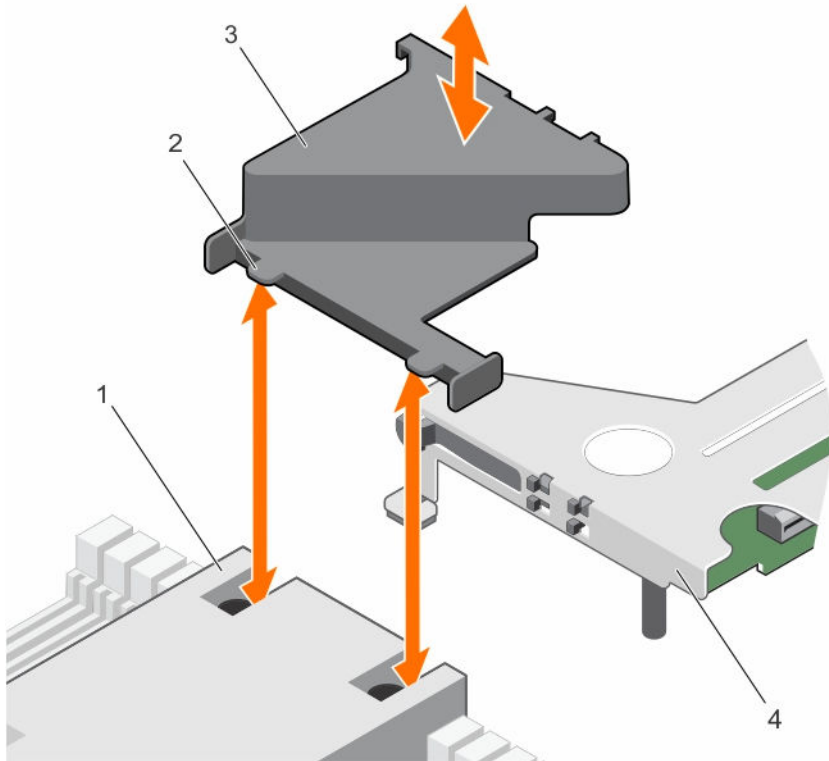

Figure 22. Removing and installing the PCIe shroud

- | | |
|------------------------------|-------------------------------|
| 1. slot on the heat sink (2) | 2. tab on the PCIe shroud (2) |
| 3. PCIe shroud | 4. expansion card riser |

Next steps

1. Install the PCIe shroud.

Related Tasks

[Installing the PCIe shroud](#)

Installing the PCIe shroud

Prerequisites

⚠ CAUTION: Many repairs may only be done by a certified service technician. You should only perform troubleshooting and simple repairs as authorized in your product documentation, or as directed by the online or telephone service and support team. Damage due to servicing that is not authorized by Dell is not covered by your warranty. Read and follow the safety instructions that came with the product.

Ensure that you read the [Safety instructions](#).

Steps

Insert the tabs on the PCIe shroud into the slots on the heat sink.

Next steps

Follow the procedure listed in [After working inside your system](#).

Expansion card riser and expansion cards

Expansion card installation guidelines

Depending on your system configuration, the following PCI Express generation 3 expansion cards are supported:

Table 4. Supported expansion cards

Configuration	PCIe slot	Processor connection	Height	Length	Link width	Slot width
Four GPUs with switch board and one processor (Configuration A)	1	Processor 1	Low Profile	Half Length	x8	x16
	2	Processor 1	Low Profile	Half Length	x16	x16
Four GPUs with switch board and two processors (Configuration B)	1	Processor 1	Low Profile	Half Length	x8	x16
	2	Processor 1	Low Profile	Half Length	x16	x16
Four GPUs without switch board and two processors (Configuration C)	1	Processor 1	Low Profile	Half Length	x8	x16
	2	Processor 2	Low Profile	Half Length	x8	x16
Two GPUs without switch board and two processors (Configuration D)	1	Processor 1	Low Profile	Half Length	x16	x16
	2	Processor 2	Low Profile	Half Length	x16	x16
Two GPUs without switch board and one processor (Configuration E)	1	Processor 1	Low Profile	Half Length	x8	x16
	2	NA	NA	NA	NA	NA
Two GPUs without switch board and two processors (Configuration F)	1	Processor 1	Low Profile	Half Length	x8	x16
	2	Processor 2	Low Profile	Half Length	x8	x16

Configuration	PCIe slot	Processor connection	Height	Length	Link width	Slot width
Four GPUs with switch board with dual GPU virtual mode and two processors (Configuration G)	1	Processor 1	Low Profile	Half Length	x16	x16
	2	Processor 2	Low Profile	Half Length	x16	x16
Three GPUs without switch board and two processors (Configuration H)	1	Processor 1	Low Profile	Half Length	x8	x16
	2	Processor 2	Low Profile	Half Length	x8	x16
Three GPUs without switch board and two processors (Configuration I)	1	Processor 1	Low Profile	Half Length	x8	x16
	2	NA	NA	NA	NA	NA

 **NOTE:** Configuration G supports virtual mode. In the virtual mode, GPUs 1 and 2 are connected to processor 1 and GPUs 3 and 4 are connected to processor 2.

The following table provides guidelines for installing expansion cards to ensure proper cooling and mechanical fit. The expansion cards with the highest priority should be installed first using the slot priority indicated. All other expansion cards should be installed in the card priority and slot priority order.

 **NOTE:** The x16 link width riser cards on the expansion card riser are cabled to the system board.

 **NOTE:** The expansion card slots are not hot swappable.

Table 5. Expansion card installation order

Card priority	Card type	Configurations A, B, C, D, F, G, and H		Configurations E and I	
		Slot priority	Max allowed	Slot priority	Max allowed
1	RAID H730P (low profile)	1	1	1	1
2	RAID H730 (low profile)	1	1	1	1
3	RAID H330 (low profile)	1	1	1	1
4	RAID H830 (low profile)	1, 2	2	1	1
5	RAID H810 (low profile)	1, 2	2	1	1
6	12 GB SAS HBA (low profile)	1, 2	2	1	1
7	Mellanox dual port InfiniBand adapter	1, 2	2	1	1
8	Mellanox single port InfiniBand adapter	1, 2	2	1	1
9	QLOGIC dual port 16 Gbps Fibre Channel adapter	1, 2	2	1	1

Card priority	Card type	Configurations A, B, C, D, F, G, and H		Configurations E and I	
		Slot priority	Max allowed	Slot priority	Max allowed
10	EMULEX dual port 16 Gbps Fibre Channel adapter	1, 2	2	1	1
11	QLOGIC single port 16 Gbps Fibre Channel adapter	1, 2	2	1	1
12	EMULEX single port 16 Gbps Fibre Channel adapter	1, 2	2	1	1
13	10 Gb NICs (low profile)	1, 2	2	1	1
14	10 Gb SFP+ NICs (low profile)	1, 2	2	1	1

Removing the expansion card riser

Prerequisites

 **CAUTION:** Many repairs may only be done by a certified service technician. You should only perform troubleshooting and simple repairs as authorized in your product documentation, or as directed by the online or telephone service and support team. Damage due to servicing that is not authorized by Dell is not covered by your warranty. Read and follow the safety instructions that came with the product.

1. Ensure that you read the [Safety instructions](#).
2. Follow the procedure listed in [Before working inside your system](#).
3. Remove the PCIe shroud. See [Removing the PCIe shroud](#).
4. If installed, disconnect the expansion card riser cables from the system board.

 **CAUTION:** The expansion card riser cables must be removed before removing the expansion card riser to prevent pin damage in the PCIe connectors on the system board.

Steps

Holding the touch points, lift the expansion card riser from the riser connector on the system board.

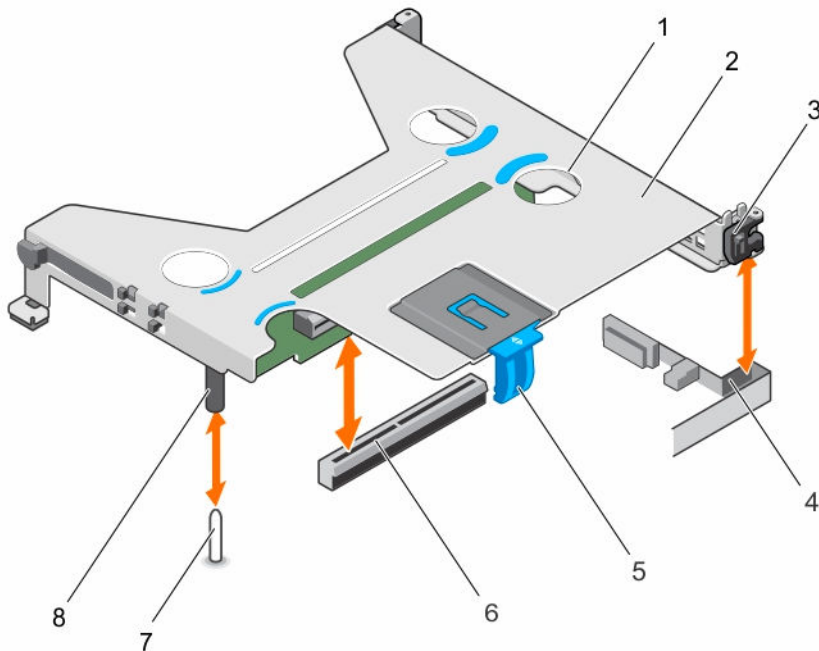

Figure 23. Removing and installing the expansion card riser

- | | |
|----------------------------------|---|
| 1. touch point (4) | 2. expansion card riser |
| 3. expansion card clip | 4. guide slot on the chassis |
| 5. expansion card latch | 6. riser connector on the system board |
| 7. guide pin on the system board | 8. guide post on the expansion card riser |

Next steps

1. Install the expansion card, if applicable.
2. Install the expansion card riser.

CAUTION: The expansion card riser cables must be removed before removing the expansion card riser to prevent pin damage in the PCIe connectors on the system board.

Related Tasks

[Installing expansion cards](#)

[Installing the expansion card riser](#)

Installing the expansion card riser

Prerequisites

CAUTION: Many repairs may only be done by a certified service technician. You should only perform troubleshooting and simple repairs as authorized in your product documentation, or as directed by the online or telephone service and support team. Damage due to servicing that is not authorized by Dell is not covered by your warranty. Read and follow the safety instructions that came with the product.

1. Ensure that you read the [Safety instructions](#).

2. Follow the procedure listed in [Before working inside your system](#).
3. If applicable, install the expansion card(s) into the expansion card riser. For more information, see [Installing expansion cards](#).

Steps

1. Align the expansion card riser with the guide pin on the system board and the guide slot on the chassis.
2. Lower the expansion card riser and press it until it clicks into place.

 **CAUTION: The expansion card riser should be installed in the system before you install the expansion card riser cables to prevent pin damage in the PCIe connectors on the system board.**

Next steps

1. If applicable, connect the riser cables to the system board.
2. Install the PCIe shroud.
3. Follow the procedure listed in [After working inside your system](#).
4. Install any device drivers required for the expansion card. For more information, see the documentation for the card.

Related Tasks

[Installing the PCIe shroud](#)

Removing expansion cards

Prerequisites

 **CAUTION: Many repairs may only be done by a certified service technician. You should only perform troubleshooting and simple repairs as authorized in your product documentation, or as directed by the online or telephone service and support team. Damage due to servicing that is not authorized by Dell is not covered by your warranty. Read and follow the safety instructions that came with the product.**

1. Ensure that you read the [Safety instructions](#).
2. Follow the procedure listed in [Before working inside your system](#).
3. Disconnect any cables connected to the expansion card and the system board.

 **CAUTION: The expansion card riser cables should be removed before removing the expansion card riser to prevent pin damage in the PCIe connectors on the system/switch board.**

4. Remove the PCIe shroud. For more information, see [Removing the PCIe shroud](#).
5. Remove the expansion card riser. For more information, see [Removing expansion cards](#).

Steps

1. Pull the expansion card latch to open it.
2. Open the expansion card clip.
3. Hold the expansion card by its edges, and remove it from the expansion card connector.
4. If you are removing the expansion card permanently, install an expansion card blank by performing the following steps:
 - a. Slide the expansion card blank into the expansion card slot on the side of the expansion card riser.

- b. Close the expansion card clip.

NOTE: You must install an expansion card blank to maintain Federal Communications Commission (FCC) certification of the system. The expansion card blank keeps dust and dirt out of the system and aids in proper cooling and airflow inside the system.

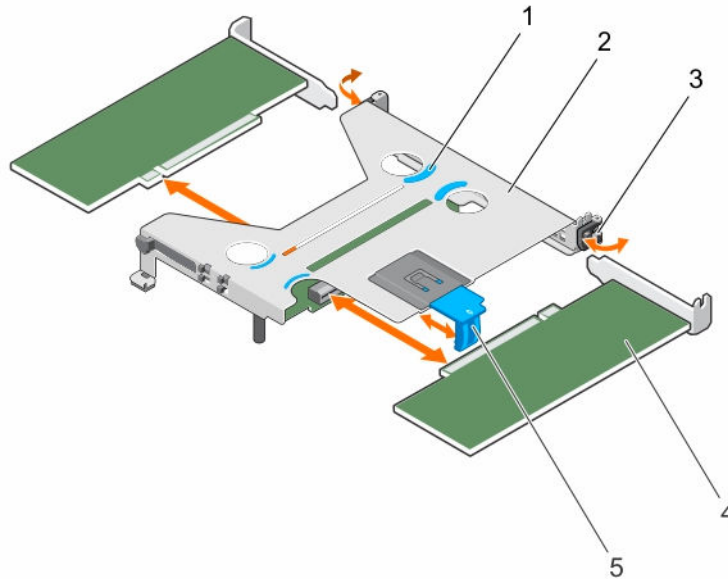

Figure 24. Removing and installing the expansion card from the expansion card riser

1. touch point (4)
2. expansion card riser
3. expansion card clip
4. expansion card (low-profile, half-length card)
5. expansion card latch

Next steps

1. Close the expansion card latch.
2. Install the expansion card riser.

Related Tasks

[Installing the expansion card riser](#)

Installing expansion cards

Prerequisites

CAUTION: Many repairs may only be done by a certified service technician. You should only perform troubleshooting and simple repairs as authorized in your product documentation, or as directed by the online or telephone service and support team. Damage due to servicing that is not authorized by Dell is not covered by your warranty. Read and follow the safety instructions that came with the product.

1. Ensure that you read the [Safety instructions](#).
2. Follow the procedure listed in [Before working inside your system](#).

3. Remove the PCIe shroud. For more information, see [Removing the PCIe shroud](#).
4. Remove the expansion card riser cables.

CAUTION: The expansion card riser cables should be removed before removing the expansion card riser to prevent pin damage in the PCIe connectors on the system/switch board.

5. Remove the expansion card riser. For more information, see [Removing the expansion card riser](#).

Steps

1. Locate the expansion card connector on the expansion card riser.
2. Open the expansion card clip.
3. If the expansion card blank is installed, slide it out of the expansion card slot on the side of the expansion card riser.

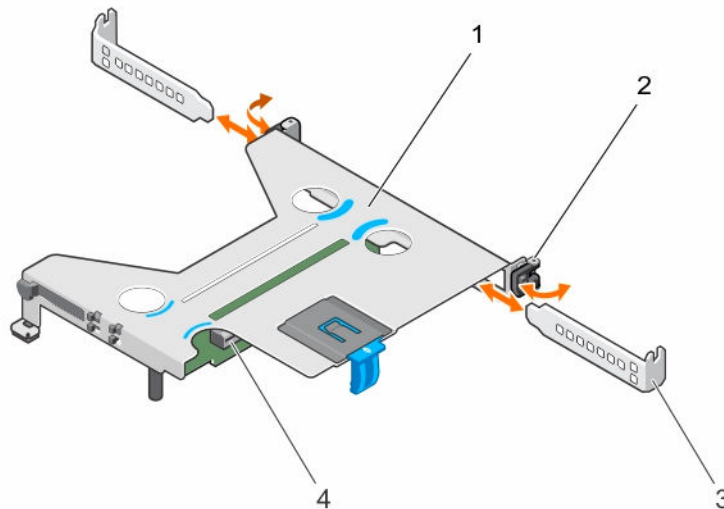

Figure 25. Removing and installing an expansion card blank

- | | |
|-------------------------|---|
| 1. expansion card riser | 2. expansion card clip |
| 3. expansion card blank | 4. expansion card connector on the expansion card riser |
4. Pull the expansion card latch to open it.
 5. Hold the expansion card by its edges and align the expansion card-edge connector with the expansion card connector.
 6. Insert the expansion card-edge connector into the expansion card connector until the expansion card is fully seated.
 7. Close the expansion card latch.
 8. Close the expansion card clip.

Next steps

1. Connect the cables to the expansion card and the system board.

CAUTION: The expansion card riser should be installed in the system before you install the expansion card riser cables to prevent pin damage in the PCIe connectors on the system board.

2. Install the expansion card riser.

3. Install the PCIe shroud.
4. Follow the procedure listed in [After working inside your system.](#)

Related Tasks

[Installing the expansion card riser](#)

[Installing the PCIe shroud](#)

Expansion card cabling diagrams

Cabling two expansion cards

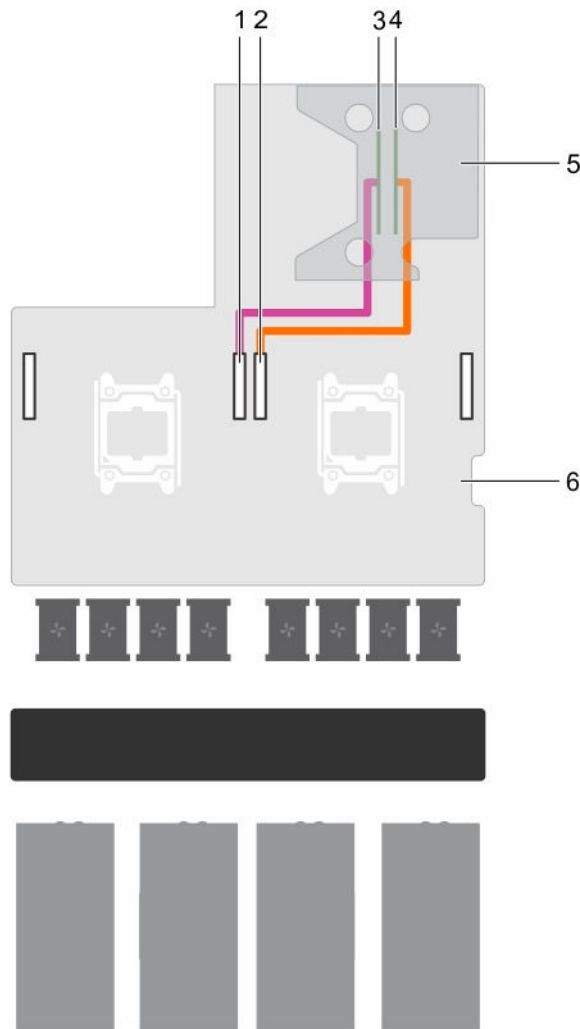

Figure 26. Cabling two expansion cards

1. GPU 4 PCIe connector on the system board
2. GPU 1 PCIe connector on the system board

- 3. expansion slot 2 connector (x16)
- 4. expansion slot 1 connector (x16)
- 5. expansion card riser
- 6. system board

Cabling one expansion card

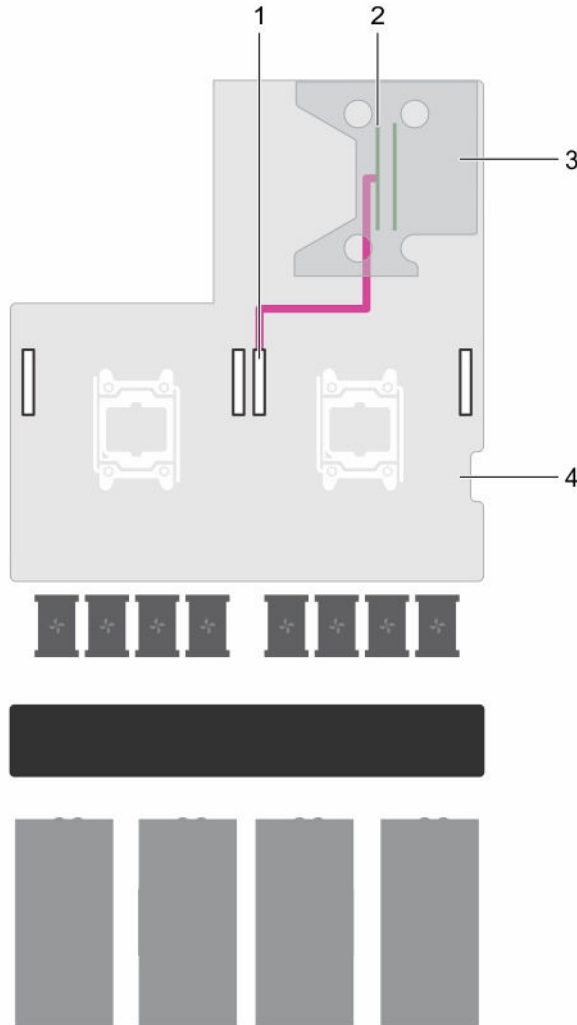



Figure 27. Cabling one expansion card

- 1. GPU 1 PCIe connector on the system board
- 2. expansion slot 2 connector (x16)
- 3. expansion card riser
- 4. system board

Power supply units

Your system supports up to:

- Two 1600 W AC power supply units (PSUs) or
- Two 1100 W AC PSUs (only for systems that support two GPUs)

 **NOTE:** The PSU 2 slot also functions as the optional 2.5 inch hard drive cage slot. If you install the 2.5 inch hard drive cage in the PSU 2 slot, your system will not support the redundancy feature.

 **NOTE:** Platinum 1600 W PSU is rated for 200 V AC to 240 V AC input only.

 **NOTE:** When two identical PSUs are installed, power supply redundancy (1+1 – with redundancy or 2+0 – without redundancy) is configured in system BIOS. In redundant mode, power is supplied to the system equally from both PSUs when Hot Spare is disabled. When Hot Spare is enabled, one of the PSUs will be put into standby when system utilization is low in order to maximize efficiency.

 **NOTE:** If two PSUs are used, they must be of the same maximum output power.

 **NOTE:** For AC PSUs, use only PSUs with the Extended Power Performance (EPP) label on the back. Mixing PSUs from previous generations of servers can result in a PSU mismatch condition or failure to power on.

Hot Spare feature

Your system supports the Hot Spare feature that significantly reduces the power overhead associated with power supply redundancy.

When the Hot Spare feature is enabled, one of the redundant PSUs is switched to the sleep state. The active PSU supports 100% of the load, thus operating at higher efficiency. The PSU in the sleep state monitors output voltage of the active PSU. If the output voltage of the active PSU drops, the PSU in the sleep state returns to an active output state.

If having both PSUs active is more efficient than having one PSU in a sleep state, the active PSU can also activate a sleeping PSU.

The default PSU settings are as follows:

- If the load on the active PSU is more than 50%, then the redundant PSU is switched to the active state.
- If the load on the active PSU falls below 20%, then the redundant PSU is switched to the sleep state.

You can configure the Hot Spare feature by using the iDRAC settings. For more information on iDRAC settings, see the Integrated Dell Remote Access Controller User's Guide at dell.com/support/home.

Removing the power supply unit blank

Remove the power supply unit (PSU) blank when you are installing a second PSU or a 2.5 inch hard drive cage in the PSU 2 slot.

Prerequisites

CAUTION: Many repairs may only be done by a certified service technician. You should only perform troubleshooting and simple repairs as authorized in your product documentation, or as directed by the online or telephone service and support team. Damage due to servicing that is not authorized by Dell is not covered by your warranty. Read and follow the safety instructions that came with the product.

Ensure that you read the [Safety instructions](#).

Steps

Remove the PSU blank from the PSU 2 slot by pulling the blank outward.

CAUTION: To ensure proper system cooling, the PSU blank must be installed in the PSU 2 slot in a non-redundant configuration. Remove the PSU blank only if you are installing a second PSU or a 2.5 inch hard drive cage.

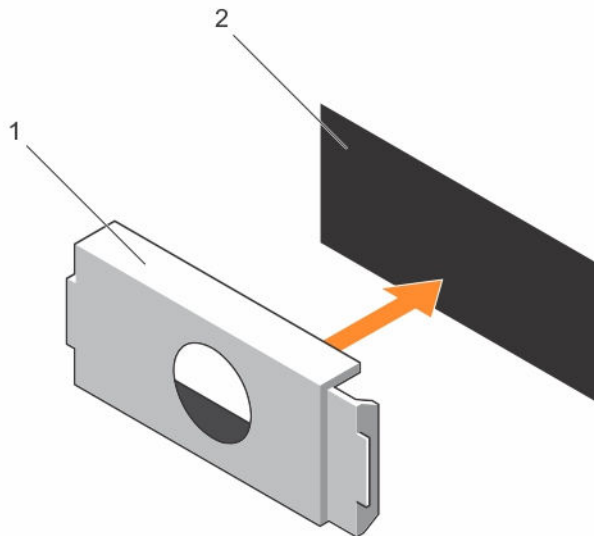

Figure 28. Removing and installing the PSU blank

1. PSU blank

2. PSU slot

Next steps

Install PSU 2 or the 2.5 inch hard drive cage.

Related Tasks

[Installing an AC power supply unit](#)

[Installing the optional 2.5 inch hard drive cage](#)

Installing the power supply unit blank

Install the power supply unit (PSU) blank when you remove PSU 2 or the 2.5 inch hard drive cage from the PSU 2 slot. Install the PSU blank only in the PSU 2 slot.

Prerequisites

 **CAUTION:** Many repairs may only be done by a certified service technician. You should only perform troubleshooting and simple repairs as authorized in your product documentation, or as directed by the online or telephone service and support team. Damage due to servicing that is not authorized by Dell is not covered by your warranty. Read and follow the safety instructions that came with the product.

1. Ensure that you read the [Safety instructions](#).
2. If applicable, remove PSU 2 or the 2.5 inch hard drive cage. For more information, see [Removing an AC power supply unit](#) or [Removing the optional 2.5 inch hard drive cage](#).

Steps

Align the power supply unit blank with the power supply unit slot and push it into the power supply unit slot until it clicks into place.

Removing an AC power supply unit

Prerequisites

 **CAUTION:** Many repairs may only be done by a certified service technician. You should only perform troubleshooting and simple repairs as authorized in your product documentation, or as directed by the online or telephone service and support team. Damage due to servicing that is not authorized by Dell is not covered by your warranty. Read and follow the safety instructions that came with the product.

 **CAUTION:** The system requires one power supply unit (PSU) for normal operation. On power-redundant systems, remove and install only one PSU at a time in a system that is powered on.

1. Ensure that you read the [Safety instructions](#).
2. Disconnect the power cable from the power source and from the PSU you intend to remove.
3. Remove the cables from the strap on the PSU.

Steps

Press the release latch and slide the PSU out of the PSU slot by holding the PSU handle.

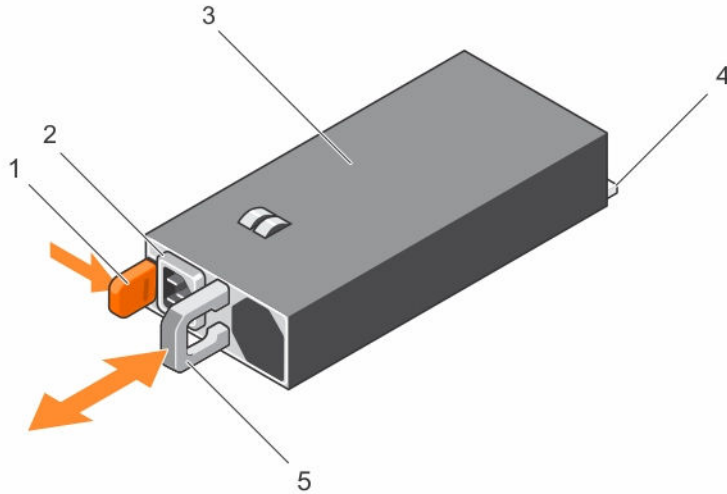

Figure 29. Removing and installing an AC PSU

- | | |
|------------------|------------------------------|
| 1. release latch | 2. PSU power cable connector |
| 3. PSU | 4. PSU connector |
| 5. PSU handle | |

Next steps

Depending on your requirement, perform one of the following steps:

- If you are not replacing PSU 2 immediately, install a PSU blank.
- Install the replacement AC PSU.
- Install the 2.5 inch hard drive cage.

Related Tasks

- [Installing an AC power supply unit](#)
- [Installing the power supply unit blank](#)
- [Installing the optional 2.5 inch hard drive cage](#)

Installing an AC power supply unit

Prerequisites

CAUTION: Many repairs may only be done by a certified service technician. You should only perform troubleshooting and simple repairs as authorized in your product documentation, or as directed by the online or telephone service and support team. Damage due to servicing that is not authorized by Dell is not covered by your warranty. Read and follow the safety instructions that came with the product.

1. Ensure that you read the [Safety instructions](#).
2. For systems that support redundant power supply units (PSUs), ensure that both the PSUs are of the same type and same maximum output power.

 **NOTE:** The maximum output power (shown in watts) is listed on the PSU label.

3. If applicable, remove the PSU blank. For more information, see [Removing the power supply unit blank](#).

Steps

1. Slide the replacement PSU into the PSU slot until the PSU is fully seated and the release latch snaps into place.

 **CAUTION:** When connecting the power cable, secure the cable with the strap.

2. Connect the PSU power cable to the PSU power cable connector.

 **NOTE:** When installing, hot swapping, or hot adding a new PSU, wait for 15 seconds for the system to recognize the PSU and determine its status. The power supply redundancy may not occur until the new PSU discovery is complete. Wait until the new PSU is discovered and enabled before you remove the other PSU. The PSU status indicator turns green to signify that the PSU is functioning properly.

3. Plug the power cable into a power outlet.

Hard drives

Your system supports up to four 2.5 inch SAS or SATA cabled hard drives.

 **NOTE:** SAS and SATA hard drives cannot be mixed in a system.

 **NOTE:** Use only SAS and SATA hard drives that have been tested and approved for your system.

 **CAUTION:** Do not turn off or reboot your system while the hard drive is being formatted. Doing so can cause a hard drive failure.

When you format a hard drive, allow enough time for the formatting to be completed. High-capacity hard drives can take a number of hours to format.

Removing the optional 2.5 inch hard drive cage

The PSU 2 slot also functions as the optional 2.5 inch hard drive cage slot.

Prerequisites

 **CAUTION:** Many repairs may only be done by a certified service technician. You should only perform troubleshooting and simple repairs as authorized in your product documentation, or as directed by the online or telephone service and support team. Damage due to servicing that is not authorized by Dell is not covered by your warranty. Read and follow the safety instructions that came with the product.

1. Ensure that you read the [Safety instructions](#).
2. Follow the procedure listed in [Before working inside your system](#).
3. Disconnect the power cable from the system board.
4. Disconnect the signal cable from the system board or expansion card.
5. Keep the Phillips #1 screwdriver ready.

Steps

1. Remove the screw securing the hard drive cage to the hard drive cage slot.

NOTE: When you slide the hard drive cage out of the hard drive cage slot, ensure that the cables disconnected from the system board do not interfere with other components on the system board.

2. Slide the hard drive cage out of the hard drive cage slot.

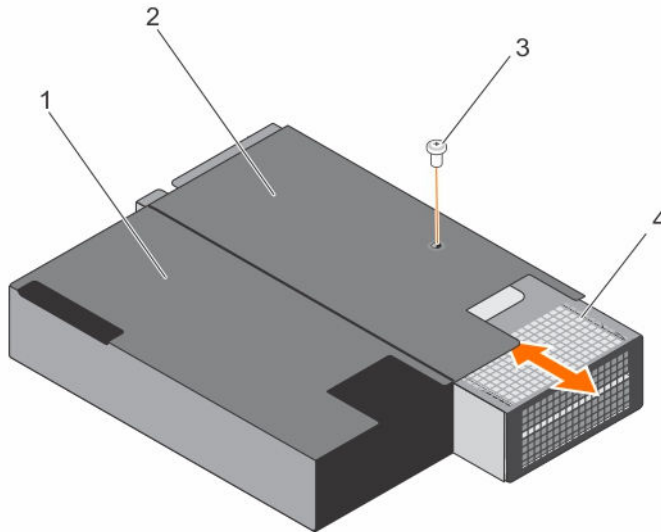

Figure 30. Removing and installing the 2.5 inch hard drive cage

1. PSU 1 slot
2. PSU 2 slot/2.5 inch hard drive cage slot
3. screw
4. hard drive cage

Next steps

If you are removing the hard drive cage permanently, install any one of the following:

- PSU blank
- PSU 2
- 2.5 inch hard drive cage

Related Tasks

[Installing the power supply unit blank](#)

[Installing an AC power supply unit](#)

[Installing the optional 2.5 inch hard drive cage](#)

Installing the optional 2.5 inch hard drive cage

The PSU 2 slot also functions as the optional 2.5 inch hard drive cage slot. If you install the 2.5 inch hard drive cage in the PSU 2 slot, your system will not support the redundancy feature.

Prerequisites

CAUTION: Many repairs may only be done by a certified service technician. You should only perform troubleshooting and simple repairs as authorized in your product documentation, or as directed by the online or telephone service and support team. Damage due to servicing that is not authorized by Dell is not covered by your warranty. Read and follow the safety instructions that came with the product.

1. Ensure that you read the [Safety instructions](#).
2. Follow the procedure listed in [Before working inside your system](#).
3. Remove the PSU/PSU blank, if installed. See [Removing the power supply unit blank](#), [Removing an AC power supply unit](#).
4. Install the 2.5 inch hard drives in the hard drive cage. See [Installing a 2.5 inch cabled hard drive into the hard drive cage](#).
5. Route the power and signal cables through the hard drive cage slot.
6. Keep the Phillips #1 screwdriver ready.

Steps

1. Slide the hard drive cage into the hard drive cage slot in the chassis.
2. Secure the hard drive cage to the hard drive cage slot by using the screws.

Next steps

1. Connect the power cable to the system board.
2. Connect the signal cables to the system board or expansion card.
3. Follow the procedure listed in [After working inside your system](#).

Removing the optional 2.5 inch hard drive cage cover

Prerequisites



CAUTION: Many repairs may only be done by a certified service technician. You should only perform troubleshooting and simple repairs as authorized in your product documentation, or as directed by the online or telephone service and support team. Damage due to servicing that is not authorized by Dell is not covered by your warranty. Read and follow the safety instructions that came with the product.

1. Ensure that you read the [Safety instructions](#).
2. Follow the procedure listed in [Before working inside your system](#).
3. Remove the 2.5 inch hard drive cage. For more information, see [Removing the optional 2.5 inch hard drive cage](#).
4. Keep the Phillips #1 screwdriver ready.

Steps

1. Remove the screws securing the hard drive cage cover to the hard drive cage.
2. Slide the hard drive cage cover toward the front of the hard drive cage to disengage it from the slots on the hard drive cage.
3. Lift the hard drive cage cover away from the hard drive cage.

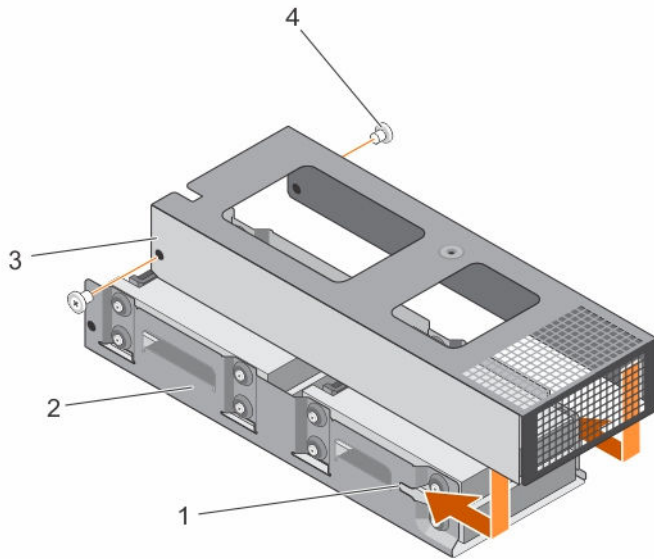

Figure 31. Removing and installing the 2.5 inch hard drive cage cover

- | | |
|------------------------------------|--------------------|
| 1. slot on the hard drive cage (2) | 2. hard drive cage |
| 3. hard drive cage cover | 4. screw (2) |

Next steps

Depending on your requirement, install or remove the 2.5 inch hard drive(s).

Related Tasks

[Installing a 2.5 inch cabled hard drive into the hard drive cage](#)

[Removing 2.5 inch cabled hard drives from the hard drive cage](#)

Installing the optional 2.5 inch hard drive cage cover

Prerequisites

CAUTION: Many repairs may only be done by a certified service technician. You should only perform troubleshooting and simple repairs as authorized in your product documentation, or as directed by the online or telephone service and support team. Damage due to servicing that is not authorized by Dell is not covered by your warranty. Read and follow the safety instructions that came with the product.

1. Ensure that you read the [Safety instructions](#).
2. Follow the procedure listed in [Before working inside your system](#).
3. Remove the hard drive cage. See [Removing the optional 2.5 inch hard drive cage](#).
4. If applicable, install the 2.5 inch hard drive(s) into the hard drive cage. See [Installing a 2.5 inch cabled hard drive into the hard drive cage](#).
5. Connect the power and signal cable(s) to the hard drive(s) in the hard drive cage.

Steps

1. Lower the hard drive cage cover onto the hard drive cage.
2. Slide the hard drive cage cover toward the back of the cage to engage it with the slots on the hard drive cage.

3. Use the screws to secure the hard drive cage cover to the hard drive cage.

Next steps

1. Install the hard drive cage into the PSU 2 slot/2.5 inch hard drive slot on the chassis.
2. Follow the procedure listed in [After working inside your system](#).

Removing 2.5 inch cabled hard drives from the hard drive cage

Prerequisites

 **CAUTION:** Many repairs may only be done by a certified service technician. You should only perform troubleshooting and simple repairs as authorized in your product documentation, or as directed by the online or telephone service and support team. Damage due to servicing that is not authorized by Dell is not covered by your warranty. Read and follow the safety instructions that came with the product.

1. Ensure that you read the [Safety instructions](#).
2. Follow the procedure listed in [Before working inside your system](#).
3. Keep the Phillips #2 screwdriver ready.
4. Remove the 2.5 inch hard drive cage. For more information, see [Removing the optional 2.5 inch hard drive cage](#).
5. Remove the 2.5 inch hard drive cage cover. For more information, see [Removing the optional 2.5 inch hard drive cage cover](#).

About this task

 **CAUTION:** To maintain proper system cooling, a minimum of two hard drives must be installed in hard drive 0/E and 1/F slots.

Steps

1. Remove the screws securing the hard drive to the hard drive cage.
2. Remove hard drives 0/E and 1/F by performing the following steps:
 - a. Disconnect the signal/power cable from the hard drives.
 - b. Lift hard drive 0/E out of the hard drive cage.
 - c. Slide hard drive 1/F out of the hard drive cage.

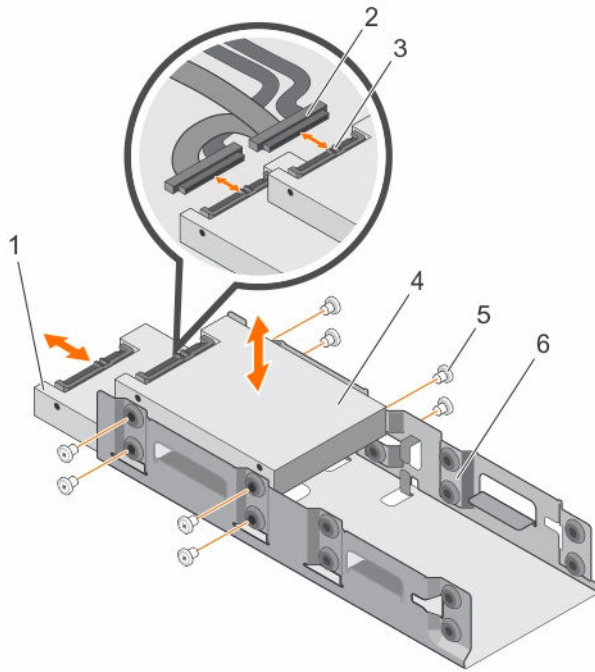

Figure 32. Removing and installing a 2.5 inch cabled hard drive (hard drive 0/E and hard drive 1/F) from the hard drive cage

- | | |
|---|---|
| 1. hard drive 1/F | 2. power and signal cable connector (2) |
| 3. power and signal cable connector on hard drive | 4. hard drive 0/E |
| 5. screw (8) | 6. hard drive cage |
- 3.** If you want to remove hard drives 2/C and 3/D, perform the following steps:
- Remove hard drives 0/E and 1/F.
 - Disconnect the signal/power cables from hard drive 2/C and 3/D.
 - Remove the signal/power cables routed through the cable clip on the hard drive cage.
 - Lift hard drive 2/C out of the hard drive cage.
 - Slide hard drive 3/D out of the hard drive cage.

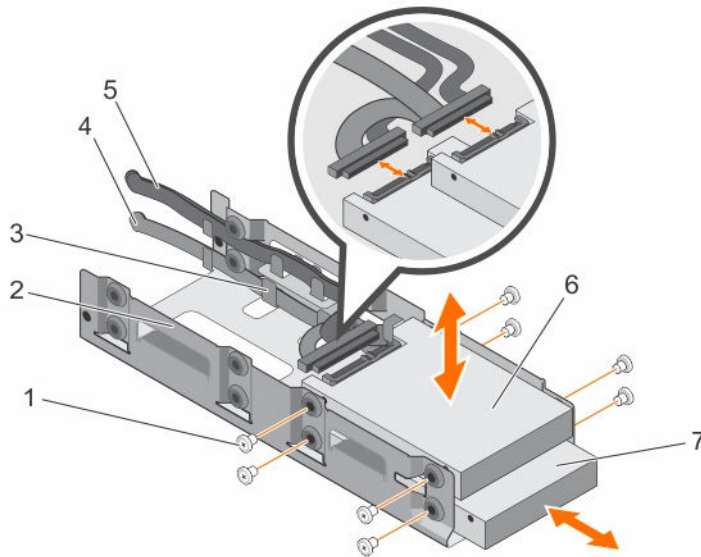

Figure 33. Removing and installing a 2.5 inch cabled hard drive (hard drive 2/C and hard drive 3/D) from the hard drive cage

- | | |
|-----------------------|--------------------|
| 1. screw (8) | 2. hard drive cage |
| 3. cable routing clip | 4. power cable |
| 5. signal cable | 6. hard drive 2/C |
| 7. hard drive 3/D | |

Next steps

1. Install the hard drives.
2. Install the hard drive cage cover.
3. Install the hard drive cage into the hard drive cage slot in the chassis.

Related Tasks

- [Installing a 2.5 inch cabled hard drive into the hard drive cage](#)
- [Installing the optional 2.5 inch hard drive cage cover](#)
- [Installing the optional 2.5 inch hard drive cage](#)

Installing a 2.5 inch cabled hard drive into the hard drive cage

Prerequisites

⚠ CAUTION: Many repairs may only be done by a certified service technician. You should only perform troubleshooting and simple repairs as authorized in your product documentation, or as directed by the online or telephone service and support team. Damage due to servicing that is not authorized by Dell is not covered by your warranty. Read and follow the safety instructions that came with the product.

1. Ensure that you read the [Safety instructions](#).

2. Keep the Phillips #2 screwdriver ready.
3. Remove the hard drive cage. For more information, see [Removing the optional 2.5 inch hard drive cage](#).
4. Remove the hard drive cage cover. For more information, see [Removing the optional 2.5 inch hard drive cage cover](#).

 **NOTE:** If you are installing four hard drives, ensure that you install hard drives 3/D and 2/C before you install hard drives 1/F and 0/E.

 **NOTE:** If you are installing two hard drives, install hard drives 1/F and 0/E.

 **NOTE:** To maintain proper system cooling, a minimum of 2 hard drives must be installed in hard drive slots 0/E and 1/F.

Steps

1. To install hard drives 3/D and 2/C, perform the following steps:
 - a. Slide hard drive 3/D into the hard drive cage.
 - b. Lower hard drive 2/C into the hard drive cage.
 - c. Secure the hard drives to the hard drive cage by using the screws.
 - d. Connect the power/signal cable to the hard drives.
 - e. Route the cables through the cable routing clip on the hard drive cage.
2. To install hard drives 1/F and 0/E, perform the following steps:
 - a. Slide hard drive 1/F into the hard drive cage.
 - b. Lower hard drive 0/E into the hard drive cage.
 - c. Secure the hard drives to the hard drive cage by using the screws.
 - d. Connect the power/signal cable to the hard drives.

Next steps

1. Install the 2.5 inch hard drive cage cover.
2. Install the hard drive cage into the hard drive cage slot.
3. Connect the power/signal cables to the system board.
4. Follow the procedure listed in [After working inside your system](#).
5. Enter System Setup and ensure that the hard drive's controller is enabled.
6. Exit the System Setup program and reboot the system.
7. Install any software required for the hard drive operation as described in the documentation for the hard drive.

Related Tasks

[Installing the optional 2.5 inch hard drive cage cover](#)

[Installing the optional 2.5 inch hard drive cage](#)

Hard drive cabling diagrams

Cabling SAS and SATA hard drives to the RAID card

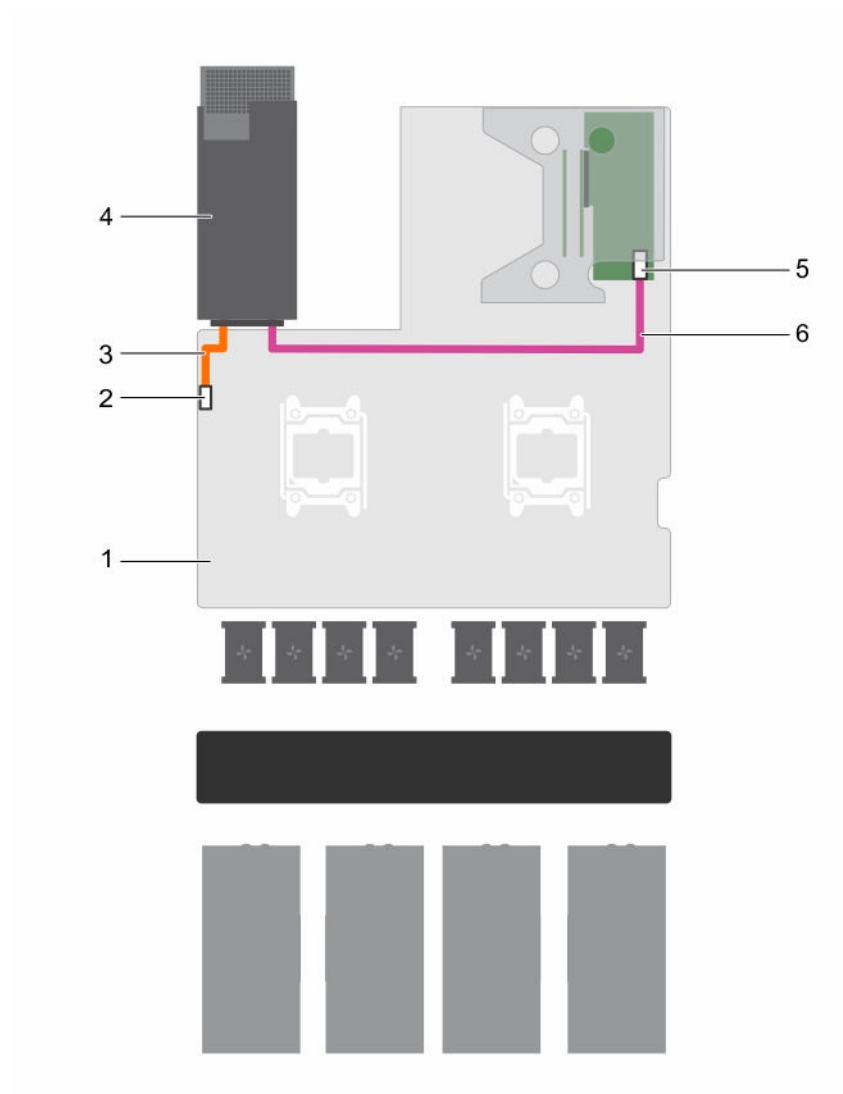

Figure 34. Cabling SAS and SATA hard drives to the RAID card

- | | |
|--------------------------------------|---|
| 1. system board | 2. 2.5 inch hard drive cage power connector |
| 3. power cable | 4. 2.5 inch hard drive cage slot |
| 5. Port A connector on the RAID card | 6. signal cable |

Cabling SATA hard drives to the SATA connector on the system board

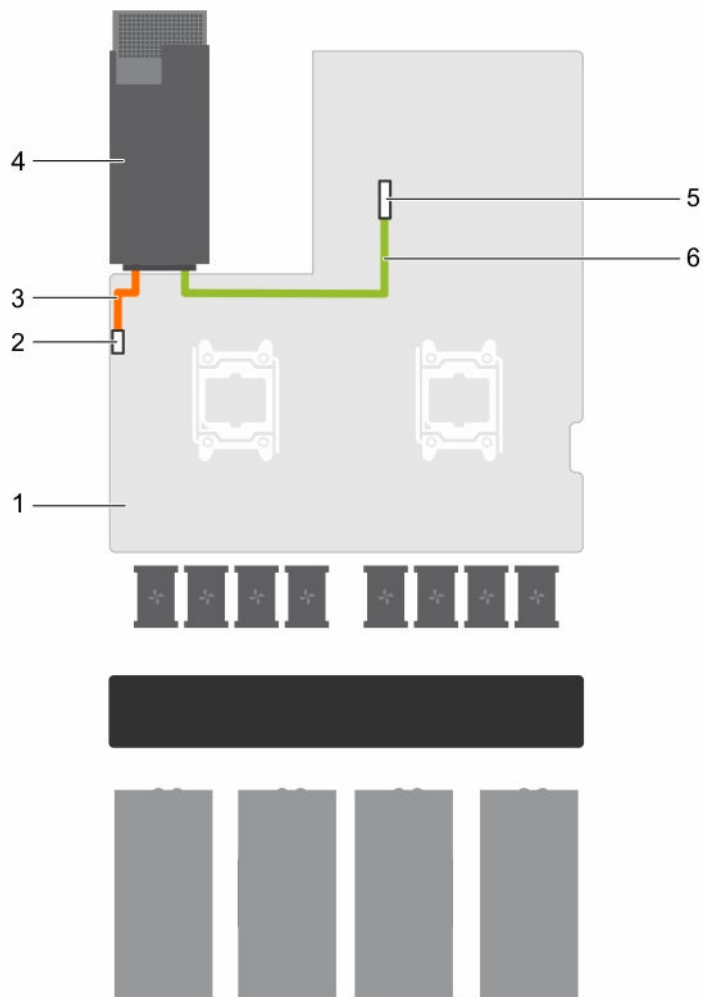



Figure 35. Cabling SATA hard drives to the SATA connector on the system board

- | | |
|---------------------------------------|---|
| 1. system board | 2. 2.5 inch hard drive cage power connector |
| 3. power cable | 4. 2.5 inch hard drive cage slot |
| 5. SATA connector on the system board | 6. signal cable |

uSATA SSDs

The PowerEdge C4130 supports up to two 1.8 inch uSATA Solid State Drives (SSDs). The uSATA SSDs connect to the system board through the hard drive backplane.

 **NOTE:** Use only SSDs that have been tested and approved for use with the hard drive backplane.

When you format an SSD, allow enough time for the formatting to be completed. High-capacity SSDs can take a number of hours to format.

Removing a 1.8 inch uSATA SSD blank

Prerequisites

1. Ensure that you read the [Safety instructions](#).

 **CAUTION:** To maintain proper system cooling, all empty SSD slots must have SSD blanks installed.

Steps

Press the release button and slide the SSD blank out of the SSD slot.

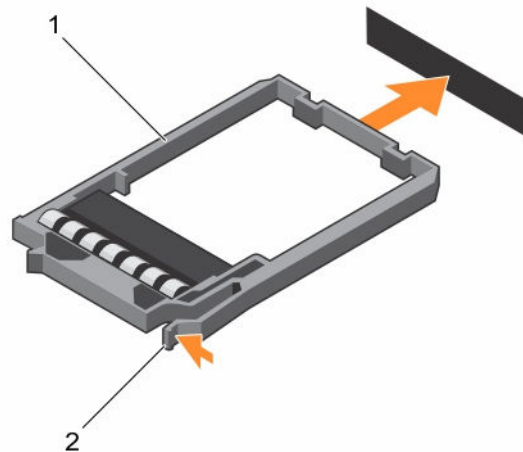

Figure 36. Removing and installing a 1.8 inch SSD blank

1. SSD blank
2. release button

Next steps

Install the 1.8 inch uSATA SSD carrier or SSD blank.

Related Tasks

[Installing a 1.8 inch uSATA SSD carrier](#)

[Installing a 1.8 inch uSATA SSD blank](#)

Installing a 1.8 inch uSATA SSD blank

Install the SSD blank if you are removing the SSD permanently or not replacing it immediately.

Prerequisites

Ensure that you read the [Safety instructions](#).

Steps

Insert the SSD blank into the SSD slot until the release button clicks into place.

Removing a 1.8 inch uSATA SSD carrier

You need to remove the SSD carrier because the SSD is installed in the SSD carrier.

Prerequisites

 **CAUTION:** Many repairs may only be done by a certified service technician. You should only perform troubleshooting and simple repairs as authorized in your product documentation, or as directed by the online or telephone service and support team. Damage due to servicing that is not authorized by Dell is not covered by your warranty. Read and follow the safety instructions that came with the product.

1. Ensure that you read the [Safety instructions](#).
2. Using the management software, prepare the SSD for removal. Wait until the indicators on the SSD carrier signal that the SSD can be removed safely.

If the SSD is online, the green activity/fault indicator flashes as the drive is turned off. When the SSD indicators are off, the SSD drive is ready for removal. For more information, see the documentation for the storage controller.

 **NOTE:** The 1.8 inch uSATA SSDs are hot swappable only with software RAID S130. If your system supports software RAID S130 proceed to step 4. If not, continue with step 3.

3. Turn off the system, including any attached peripherals.
4. Disconnect the system from the electrical outlet and disconnect the peripherals.

Steps

1. Press the release button to open the SSD carrier release handle.
2. Slide the SSD carrier out of the SSD cage.

The SSD is installed in the SSD carrier.

 **CAUTION:** To maintain proper system cooling, all empty SSD slots must have SSD blanks installed.

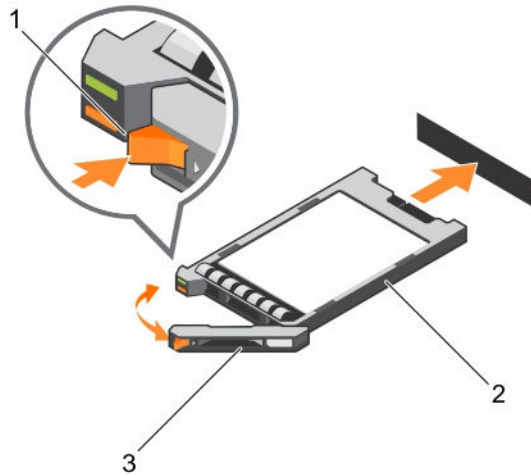

Figure 37. Removing and installing a 1.8 inch uSATA SSD carrier

- | | |
|-----------------------|----------------|
| 1. release button | 2. SSD carrier |
| 3. SSD carrier handle | |

Next steps

Depending on your requirement, perform one of the following steps:

- If you are not replacing the SSD immediately, insert an SSD blank in the empty SSD slot.
- Install the 1.8 inch uSATA SSD carrier.

Related Tasks

[Installing a 1.8 inch uSATA SSD blank](#)

[Installing a 1.8 inch uSATA SSD carrier](#)

Installing a 1.8 inch uSATA SSD carrier

Prerequisites

⚠ CAUTION: Many repairs may only be done by a certified service technician. You should only perform troubleshooting and simple repairs as authorized in your product documentation, or as directed by the online or telephone service and support team. Damage due to servicing that is not authorized by Dell is not covered by your warranty. Read and follow the safety instructions that came with the product.

1. Ensure that you read the [Safety instructions](#).

✎ NOTE: The 1.8 inch uSATA SSDs are hot swappable only with software RAID S130.

2. If your system does not support software RAID S130, turn off your system.

⚠ CAUTION: Use only SSDs that have been tested and approved for use with the SSD backplane.

Steps

1. If an SSD blank is installed in the SSD slot, remove it. For more information, see [Removing a 1.8 inch uSATA SSD blank](#).
2. Install the SSD in the SSD carrier. For more information, see [Installing a 1.8 inch uSATA SSD into a SSD carrier](#).
3. Press the release button on the front of the SSD carrier, and open the SSD carrier handle.
4. Insert the SSD carrier into the SSD slot until the carrier connects with the backplane.
5. Close the SSD carrier handle to lock the SSD in place.

Next steps

1. Connect the system to the electrical outlet and connect the peripherals
2. Turn on the system, including any attached peripherals.

Removing a 1.8 inch uSATA SSD from a SSD carrier

Prerequisites



CAUTION: Many repairs may only be done by a certified service technician. You should only perform troubleshooting and simple repairs as authorized in your product documentation, or as directed by the online or telephone service and support team. Damage due to servicing that is not authorized by Dell is not covered by your warranty. Read and follow the safety instructions that came with the product.

1. Ensure that you read the [Safety instructions](#).
2. Turn off the system, including any attached peripherals.
3. Remove the SSD carrier from the SSD cage. For more information, see [Removing a 1.8 inch uSATA SSD carrier](#).



NOTE: The SSD is installed in the SSD carrier.

Steps

1. Turn the SSD carrier over.
2. Pull the rails of the SSD carrier and lift the SSD out of the SSD carrier.

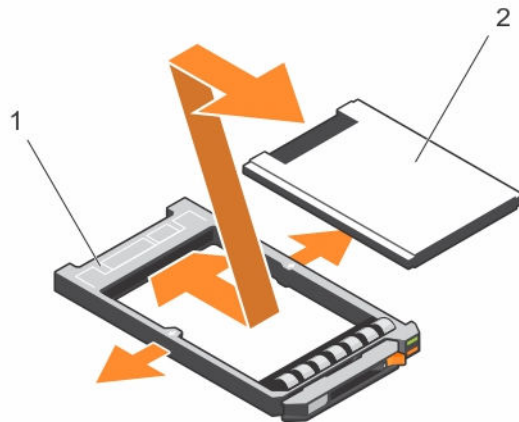

Figure 38. Removing and installing a 1.8 inch SSD into a SSD carrier

1. SSD carrier
2. SSD

Next steps

Install the SSD into the SSD carrier.

Related Tasks

[Installing a 1.8 inch uSATA SSD into a SSD carrier](#)

Installing a 1.8 inch uSATA SSD into a SSD carrier

Prerequisites

⚠ CAUTION: Many repairs may only be done by a certified service technician. You should only perform troubleshooting and simple repairs as authorized in your product documentation, or as directed by the online or telephone service and support team. Damage due to servicing that is not authorized by Dell is not covered by your warranty. Read and follow the safety instructions that came with the product.

Steps

1. Insert the SSD into the SSD carrier with the connector end of the SSD toward the back of the SSD carrier.
2. Press the SSD until it is firmly seated.

Removing the 1.8 inch uSATA SSD cage

Prerequisites

CAUTION: Many repairs may only be done by a certified service technician. You should only perform troubleshooting and simple repairs as authorized in your product documentation, or as directed by the online or telephone service and support team. Damage due to servicing that is not authorized by Dell is not covered by your warranty. Read and follow the safety instructions that came with the product.

1. Ensure that you read the [Safety instructions](#).
2. Follow the procedure listed in [Before working inside your system](#).
3. Remove the 1.8 inch SSD(s) from the SSD cage. For more information, see [Removing a 1.8 inch uSATA SSD carrier](#).

Steps

Hold the SSD cage by the edges and lift the cage out of the chassis.

The SSD backplane is attached to the SSD cage. When you lift the SSD cage, the backplane will disengage from the backplane connector on the system board.

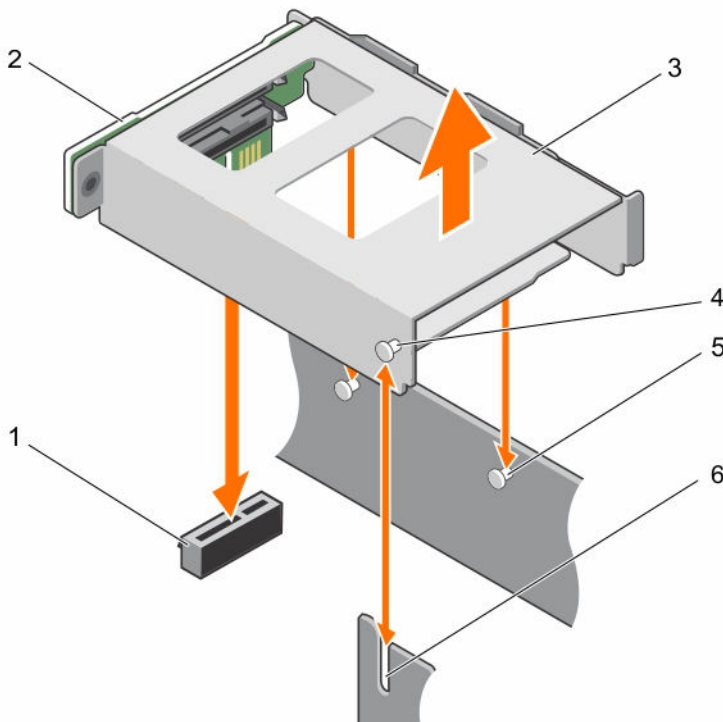

Figure 39. Removing and installing the 1.8 inch SSD cage

- | | |
|-------------------------------------|---------------------------|
| 1. 1.8 inch SSD backplane connector | 2. 1.8 inch SSD backplane |
| 3. 1.8 inch SSD cage | 4. tab on the SSD cage |

5. tab on the PSU 1 slot

6. slot on the chassis

Installing the 1.8 inch uSATA SSD cage

Prerequisites

 **CAUTION:** Many repairs may only be done by a certified service technician. You should only perform troubleshooting and simple repairs as authorized in your product documentation, or as directed by the online or telephone service and support team. Damage due to servicing that is not authorized by Dell is not covered by your warranty. Read and follow the safety instructions that came with the product.

1. Ensure that you read the [Safety instructions](#).
2. Follow the procedure listed in [Before working inside your system](#).

Steps

1. Align the tabs on the SSD cage and the PSU 1 slot with the slots on the chassis and SSD cage.
2. Press the SSD cage until the SSD backplane engages with the SSD backplane connector on the system board.

Next steps

1. Install the 1.8 inch SSD carrier or SSD blank(s) into the SSD cage.
2. Follow the procedure listed in [After working inside your system](#).

Related Tasks

[Installing a 1.8 inch uSATA SSD blank](#)

[Installing a 1.8 inch uSATA SSD carrier](#)

Removing the 1.8 inch uSATA SSD backplane

Prerequisites

 **CAUTION:** Many repairs may only be done by a certified service technician. You should only perform troubleshooting and simple repairs as authorized in your product documentation, or as directed by the online or telephone service and support team. Damage due to servicing that is not authorized by Dell is not covered by your warranty. Read and follow the safety instructions that came with the product.

1. Ensure that you read the [Safety instructions](#).
2. Follow the procedure listed in [Before working inside your system](#).
3. Keep the T10 screwdriver ready.
4. Remove both the SSD carriers. For more information, see [Removing a 1.8 inch uSATA SSD carrier](#).
5. Remove the 1.8 inch SSD cage. For more information, see [Removing the 1.8 inch uSATA SSD cage](#).

 **CAUTION:** To prevent damage to the drives and backplane, you must remove the SSD carriers from the system before removing the backplane.

 **CAUTION:** You must note the number of each SSD and temporarily label them before removal so that you can replace them in the same locations.

Steps

1. Remove the screw securing the SSD backplane to the SSD cage.
2. Remove the SSD backplane from the slot on the SSD cage.

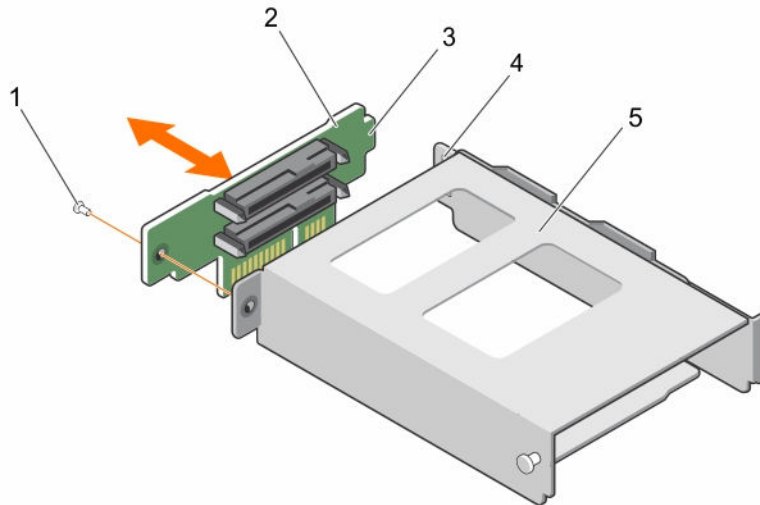

Figure 40. Removing and installing the 1.8 inch SSD backplane

- | | |
|-----------------------------|------------------------------|
| 1. screw | 2. SSD backplane |
| 3. tab on the SSD backplane | 4. slot on the SSD backplane |
| 5. SSD cage | |

Installing the 1.8 inch uSATA SSD backplane

Prerequisites

⚠ CAUTION: Many repairs may only be done by a certified service technician. You should only perform troubleshooting and simple repairs as authorized in your product documentation, or as directed by the online or telephone service and support team. Damage due to servicing that is not authorized by Dell is not covered by your warranty. Read and follow the safety instructions that came with the product.

1. Ensure that you read the [Safety instructions](#).
2. Follow the procedure listed in [Before working inside your system](#).
3. Remove the 1.8 inch SSD cage. For more information, see [Removing the 1.8 inch uSATA SSD cage](#).

✍ NOTE: The 1.8 inch SSD backplane is installed on the back of the 1.8 inch SSD cage.

Steps

1. Slide the SSD backplane into the slot on the SSD cage.
2. Align the screw hole on the SSD backplane with the screw hole on the SSD cage.
3. Secure the SSD backplane to the SSD cage by using the screw.

Next steps

1. Install the SSD cage.

2. Follow the procedure listed in [After working inside your system](#).

Related Tasks

[Installing the 1.8 inch uSATA SSD cage](#)

Internal USB memory key (optional)

The USB memory key installed inside your system can be used as a boot device, security key, or mass storage device.

To boot from the USB memory key, configure the USB memory key with a boot image and then specify the USB memory key in the boot sequence in System Setup.

The internal USB connector is located on the system board.

Replacing the internal USB key

Prerequisites



CAUTION: Many repairs may only be done by a certified service technician. You should only perform troubleshooting and simple repairs as authorized in your product documentation, or as directed by the online or telephone service and support team. Damage due to servicing that is not authorized by Dell is not covered by your warranty. Read and follow the safety instructions that came with the product.

1. Ensure that you read the [Safety instructions](#).
2. The USB connector must be enabled by the **Internal USB Port** option in the **Integrated Devices** screen of System Setup.
3. Follow the procedure listed in [Before working inside your system](#).
4. Remove the 1.8 inch uSATA SSD cage. For more information, see [Removing the 1.8 inch uSATA SSD cage](#).

Steps

1. Locate the USB connector or the USB key on the system board.
The internal USB connector is located under the 1.8 inch uSATA SSD cage. For more information, see [System board connectors](#).
2. If installed, remove the USB key from the USB connector.
3. Insert the replacement USB key into the USB connector.

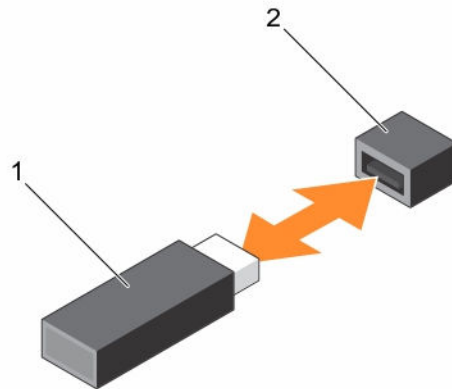

Figure 41. Replacing the internal USB key

1. USB memory key
2. USB memory key connector

Next steps

1. Install the 1.8 inch uSATA SSD cage.
2. Follow the procedure listed in [After working inside your system](#).
3. While booting, press <F2> to enter System Setup and verify that the USB key is detected by the system.

Related Tasks

[Installing the 1.8 inch uSATA SSD cage](#)

Cable routing clip

Removing the cable routing clip

Prerequisites

⚠ CAUTION: Many repairs may only be done by a certified service technician. You should only perform troubleshooting and simple repairs as authorized in your product documentation, or as directed by the online or telephone service and support team. Damage due to servicing that is not authorized by Dell is not covered by your warranty. Read and follow the safety instructions that came with the product.

1. Ensure that you read the [Safety instructions](#).
2. Follow the procedure listed in [Before working inside your system](#).
3. Disconnect and remove the cables routed through the cable routing clip.
4. Keep the Phillips #2 screwdriver ready.

Steps

1. Remove the screws securing the cable routing clip to the system board.
2. Lift the cable routing clip away from the system board.

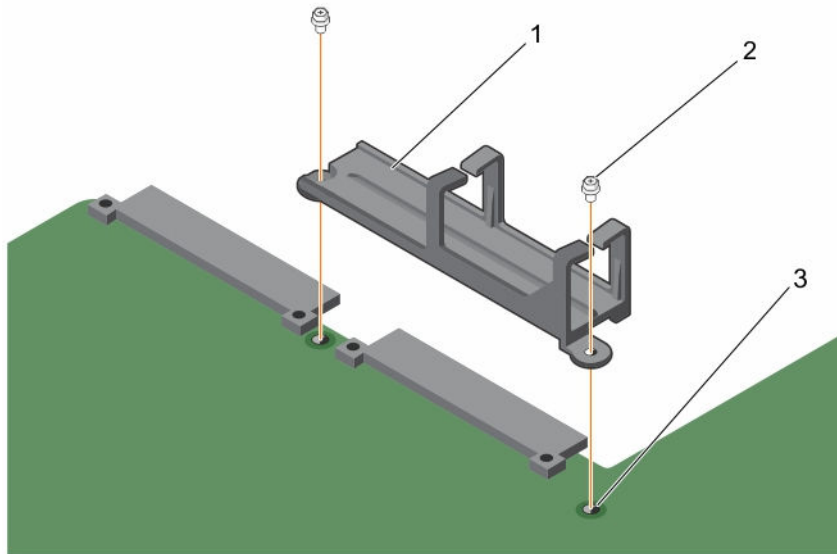

Figure 42. Removing and installing the cable routing clip

1. cable routing clip
2. screw (2)
3. screw hole on the system board (2)

Installing the cable routing clip

Prerequisites

⚠ CAUTION: Many repairs may only be done by a certified service technician. You should only perform troubleshooting and simple repairs as authorized in your product documentation, or as directed by the online or telephone service and support team. Damage due to servicing that is not authorized by Dell is not covered by your warranty. Read and follow the safety instructions that came with the product.

1. Ensure that you read the [Safety instructions](#).
2. Follow the procedure listed in [Before working inside your system](#).

Steps

1. Align the screw holes on the cable routing clip with the screw holes on the system board and lower the clip on the system board.
2. Secure the cable routing clip to the system board by using the screws.

Next steps

1. Connect and route the cables through the cable routing clip.
2. Follow the procedure listed in [After working inside your system](#).

System board

Removing the system board

Prerequisites

-  **NOTE:** This is a Field Replaceable Unit (FRU). Removal and installation procedures should be performed only by Dell certified service technicians.
-  **CAUTION:** Many repairs may only be done by a certified service technician. You should only perform troubleshooting and simple repairs as authorized in your product documentation, or as directed by the online or telephone service and support team. Damage due to servicing that is not authorized by Dell is not covered by your warranty. Read and follow the safety instructions that came with the product.
-  **CAUTION:** If you are using the Trusted Platform Module (TPM) with an encryption key, you may be prompted to create a recovery key during program or System Setup. Be sure to create and safely store this recovery key. If you replace this system board, you must supply the recovery key when you restart your system or program before you can access the encrypted data on your hard drives.
-  **CAUTION:** Do not attempt to remove the Trusted Platform Module (TPM) from the system board. Once the TPM is installed, it is cryptographically bound to that specific system board. Any attempt to remove an installed TPM breaks the cryptographic binding, and it cannot be re-installed or installed on another system board.

1. Ensure that you read the [Safety instructions](#).
2. Follow the procedure listed in [Before working inside your system](#).
3. Keep the Philips #2 screwdriver ready.
4. Remove the following components:
 - a. PCIe shroud. See [Removing the PCIe shroud](#)
 - b. Expansion card riser. See [Removing the expansion card riser](#)
 - c. PSU(s). See [Removing an AC power supply unit](#)
 - d. 2.5 inch hard drive cage, if applicable. See [Removing the optional 2.5 inch hard drive cage](#)
 - e. Internal dual SD module. See [Removing the internal dual SD module](#)
 - f. 1.8 inch SSD cage with backplane. See [Removing the 1.8 inch uSATA SSD cage](#), [Removing the 1.8 inch uSATA SSD backplane](#)
 - g. Internal USB key (if installed). See [Replacing the internal USB key](#)
 - h. Cooling shroud. See [Removing the cooling shroud](#)
 - i. Heat sink(s). See [Removing a heat sink](#)
 - j. Processor(s)/processor blank. See [Removing a processor](#), [Removing a processor blank](#)
 -  **CAUTION:** To prevent damage to the processor pins when replacing a faulty system board, ensure that you cover the processor socket with the processor protective cap.
 - k. Memory modules and memory module blanks. See [Removing memory modules](#)
 - l. Cable routing clip. See [Removing the cable routing clip](#)
5. Disconnect all cables from the system board.

Steps

1. Remove the screws that secure the system board to the chassis.

⚠ CAUTION: Take care not to damage the system identification button while removing the system board from the chassis.

⚠ CAUTION: Do not lift the system board by holding a memory module, processor, or other components.

2. Lift the system board by holding both the system board holders, and slide the system board toward the front of the chassis.

The connectors are disengaged from the back of the chassis slots.

3. Lift the system board out of the chassis.

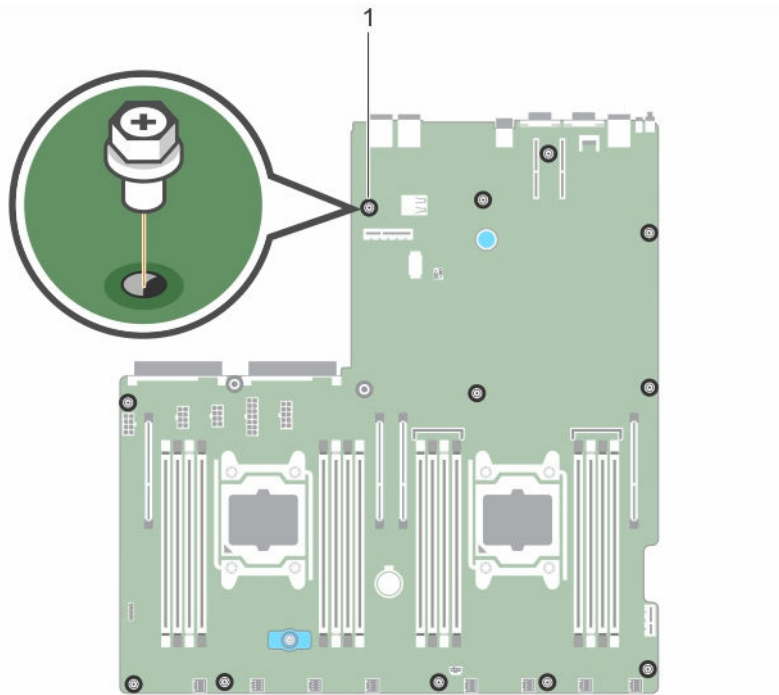

Figure 43. Removing and installing the screws on the system board

1. screw (12)

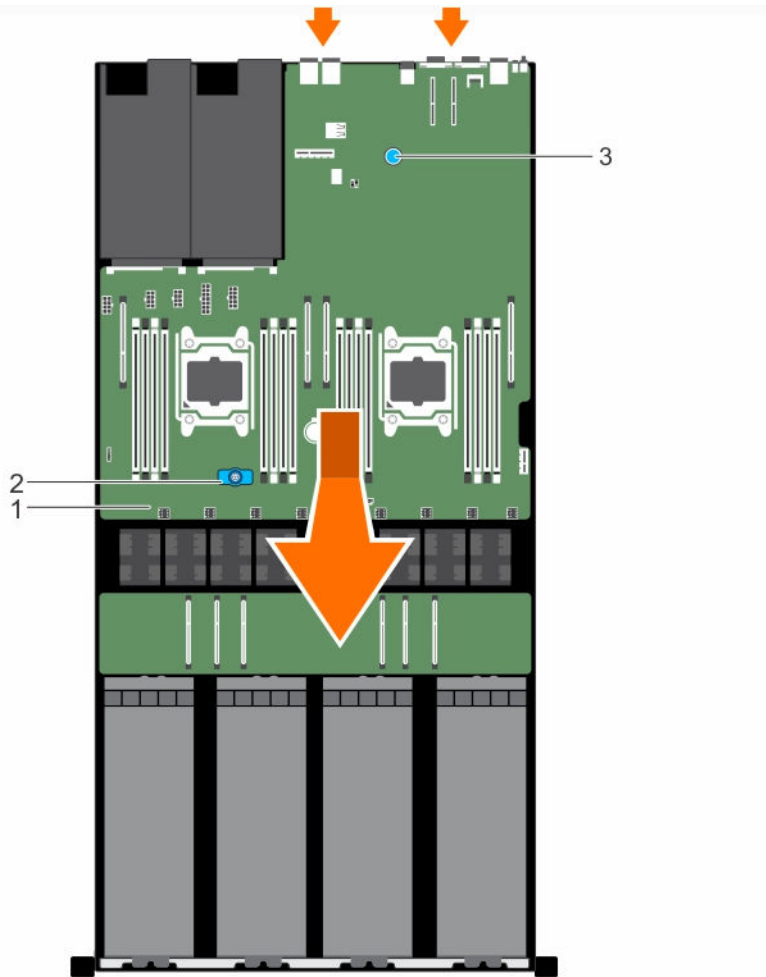

Figure 44. Removing and installing the system board

- | | |
|--|--|
| <ol style="list-style-type: none"> 1. system board 2. system board holder (front) 3. system board holder (back) | <ol style="list-style-type: none"> 2. system board holder (front) |
|--|--|

Next steps

Install the system board.

Related Tasks

[Installing the system board](#)

Installing the system board

Prerequisites

 **NOTE:** This is a Field Replaceable Unit (FRU). Removal and installation procedures should be performed only by Dell certified service technicians.

 **CAUTION:** Many repairs may only be done by a certified service technician. You should only perform troubleshooting and simple repairs as authorized in your product documentation, or as directed by the online or telephone service and support team. Damage due to servicing that is not authorized by Dell is not covered by your warranty. Read and follow the safety instructions that came with the product.

1. Ensure that you read the [Safety instructions](#).
2. Follow the procedure listed in [Before working inside your system](#).
3. Keep the Phillips #2 screwdriver ready.

Steps

1. Unpack the new system board.

 **CAUTION:** Do not lift the system board by holding a memory module, processor, or other components.

 **CAUTION:** Take care not to damage the system identification button while placing the system board into the chassis.

2. Hold the system board holders and lower the system board into the chassis at an angle so that the connectors on the back of the system board engage with the slots on the back of the chassis.
3. Push the system board toward the back of the chassis until the board is firmly seated.
4. Secure the system board to the chassis by using the screws.

Next steps

1. If applicable, install the Trusted Platform Module (TPM).
For information on installing the TPM, see [Installing the Trusted Platform Module](#).

For more information on TPM, see [Trusted Platform Module](#).
2. Replace the following components:
 - a. Internal USB key, if applicable. See [Replacing the internal USB key](#)
 - b. Internal dual SD module. See [Installing the internal dual SD module](#)
 - c. Expansion card riser. See [Installing the expansion card riser](#)
 - d. PSU(s). See [Installing an AC power supply unit](#)
 - e. 2.5 inch hard drive cage, if applicable. See [Installing the optional 2.5 inch hard drive cage](#)
 - f. Processor(s)/processor blank(s). See [Installing a processor](#), [Installing a processor blank](#)
 - g. Heat sink(s). See [Installing a heat sink](#)
 - h. PCIe shroud. See [Installing the PCIe shroud](#)
 - i. Memory modules and memory module blanks. See [Installing memory modules](#)
 - j. 1.8 inch SSD cage with the backplane. See [Installing the 1.8 inch uSATA SSD cage](#), [Installing the 1.8 inch uSATA SSD backplane](#)
 - k. Cooling shroud. See [Installing the cooling shroud](#)
 - l. Cable routing clip. See [Installing the cable routing clip](#)
3. Reconnect all cables to the system board.
 **NOTE:** Ensure that the cables inside the system are routed along the chassis wall and the GPU and hard drive cables are routed through the cable routing clip.
4. Follow the procedure listed in [After working inside your system](#).
5. Ensure that you perform the following steps:

- a. Use the **Easy Restore** feature to restore the service tag. For more information, see [Restoring the Service Tag using the Easy Restore feature](#).
- b. If the service tag is not backed up in the backup flash device, enter the system service tag manually. For more information, see [Entering the system service tag](#).
- c. Update the BIOS and iDRAC versions.
- d. Re-enable the Trusted Platform Module (TPM). For more information, see [Re-enabling the TPM for TXT users](#).

Entering the system Service Tag using System Setup

If you know the system Service Tag, use System Setup menu to enter the Service Tag.

1. Turn on the system.
2. Press <F2> to enter System Setup.
3. Click **Service Tag Settings**.
4. Enter the Service Tag.



NOTE: You can enter the Service Tag only when the **Service Tag** field is empty. Ensure that you enter the correct Service Tag. Once the Service Tag is entered, it cannot be updated or changed.

5. Click **Ok**.
6. Import your new or existing iDRAC Enterprise license.
For more information, see Integrated Dell Remote Access Controller User's Guide, at dell.com/esmmanuals.

Restoring the Service Tag using the Easy Restore feature

Use the Easy Restore feature if you do not know the Service Tag of your system. The Easy Restore feature allows you to restore your system's Service Tag, license, UEFI configuration, and the system configuration data after replacing the system board. All data is backed up in a backup flash device automatically. If BIOS detects a new system board and the Service Tag in the backup flash device, BIOS prompts the user to restore the backup information.

1. Turn on the system.
If BIOS detects a new system board, and if the Service Tag is present in the backup flash device, BIOS displays the Service Tag, the status of the license, and the **UEFI Diagnostics** version.
2. Perform one of the following steps:
 - Press **Y** to restore the Service Tag, license, and diagnostics information.
 - Press **N** to navigate to the Lifecycle Controller based restore options.
 - Press <F10> to restore data from a previously created **Hardware Server Profile**.

After the restore process is complete, BIOS prompts to restore the system configuration data.

3. Perform one of the following steps:
 - Press **Y** to restore the system configuration data.
 - Press **N** to use the default configuration settings.

After the restore process is complete, the system restarts.

Trusted Platform Module

The Trusted Platform Module (TPM) is used to generate or store keys, protect or authenticate passwords, and create or store digital certificates. TPM can also be used to enable the BitLocker hard drive encryption feature in Windows Server.

△ CAUTION: Do not attempt to remove the Trusted Platform Module (TPM) from the system board. Once the TPM is installed, it is cryptographically bound to that specific system board. Any attempt to remove an installed TPM breaks the cryptographic binding, and it cannot be re-installed or installed on another system board.

Installing the Trusted Platform Module

Prerequisites

 **NOTE:** This is a Field Replaceable Unit (FRU). Removal and installation procedures should be performed only by Dell certified service technicians.

△ CAUTION: Many repairs may only be done by a certified service technician. You should only perform troubleshooting and simple repairs as authorized in your product documentation, or as directed by the online or telephone service and support team. Damage due to servicing that is not authorized by Dell is not covered by your warranty. Read and follow the safety instructions that came with the product.

△ CAUTION: Do not attempt to remove the Trusted Platform Module (TPM) from the system board. Once the TPM is installed, it is cryptographically bound to that specific system board. Any attempt to remove an installed TPM breaks the cryptographic binding, and it cannot be re-installed or installed on another system board.

1. Ensure that you read the [Safety instructions](#).
2. Follow the procedure listed in [Before working inside your system](#).
3. If the expansion cards are installed, disconnect the riser cables from the system board.
4. Remove the expansion card riser. For more information, see [Removing the expansion card riser](#).

Steps

1. Locate the TPM connector on the system board.
The TPM connector is located under the expansion card riser.
2. Align the edge connectors on the TPM with the slot on the TPM connector.
3. Insert the TPM into the TPM connector such that the plastic bolt aligns with the slot on the system board.
4. Press the plastic bolt until the bolt clicks into place.

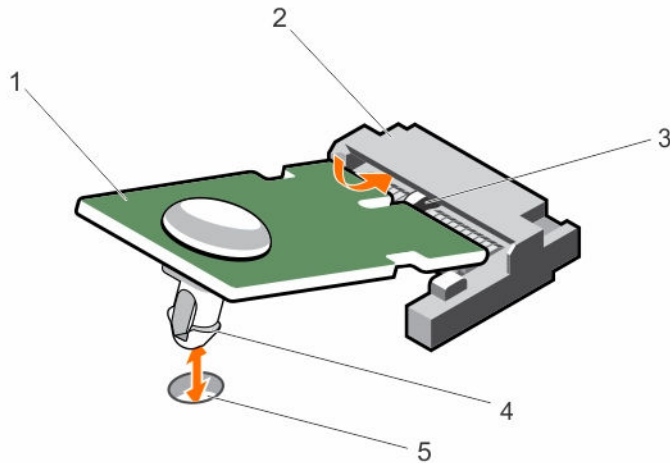

Figure 45. Installing the TPM

- | | |
|------------------------------|------------------|
| 1. TPM | 2. TPM connector |
| 3. slot on the TPM connector | 4. plastic bolt |
| 5. slot on the system board | |

Re-enabling the TPM for BitLocker users

Initialize the TPM.

For more information on initializing the TPM, see <http://technet.microsoft.com/en-us/library/cc753140.aspx>.

The **TPM Status** changes to **Enabled, Activated**.

Re-enabling the TPM for TXT users

1. While booting your system, press <F2> to enter System Setup.
2. In the **System Setup Main Menu**, click **System BIOS** → **System Security Settings**.
3. In the **TPM Security** option, select **On with Pre-boot Measurements**.
4. In the **TPM Command** option, select **Activate**.
5. Save the settings.
6. Restart your system.
7. Enter System Setup again.
8. In the **System Setup Main Menu**, click **System BIOS** → **System Security Settings**.
9. In the **Intel TXT** option, select **On**.

Cooling fans

Your system supports six cabled cooling fans.

Removing a cooling fan

Prerequisites



CAUTION: Many repairs may only be done by a certified service technician. You should only perform troubleshooting and simple repairs as authorized in your product documentation, or as directed by the online or telephone service and support team. Damage due to servicing that is not authorized by Dell is not covered by your warranty. Read and follow the safety instructions that came with the product.

1. Ensure that you read the [Safety instructions](#).
2. Follow the procedure listed in [Before working inside your system](#).
3. Remove the system top cover (front). For more information, see [Removing the system top cover \(front\)](#).



NOTE: The procedure for removing each fan is identical.

Steps

1. Disconnect the cooling fan power cable from the system board.
2. Hold the cooling fan by its edges and lift the cooling fan out of the chassis.

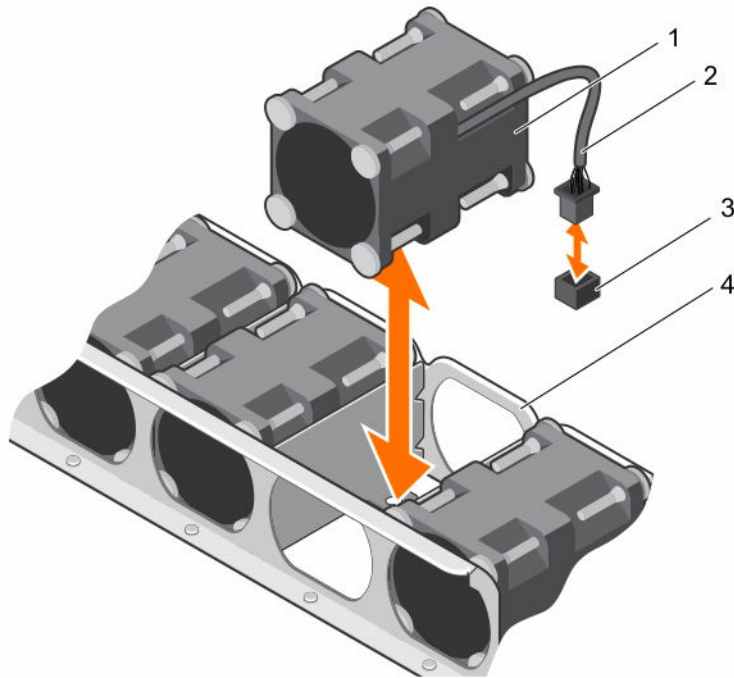

Figure 46. Removing and installing a cooling fan

- | | |
|--|----------------------------|
| 1. cooling fan (8) | 2. cooling fan power cable |
| 3. cooling fan connector on system board | 4. cooling fan slot |

Next steps

1. Install the cooling fan.

Installing a cooling fan

Prerequisites

1. Ensure that you read the [Safety instructions](#).
2. Follow the procedure listed in [Before working inside your system](#).
3. Remove the system top cover (front). For more information, see [Removing the system top cover \(front\)](#).

⚠ CAUTION: Many repairs may only be done by a certified service technician. You should only perform troubleshooting and simple repairs as authorized in your product documentation, or as directed by the online or telephone service and support team. Damage due to servicing that is not authorized by Dell is not covered by your warranty. Read and follow the safety instructions that came with the product.

Steps

1. Hold the cooling fan by the sides with the cable end facing the system board.
2. Align the cooling fan with the slot on the chassis and slide the fan into the slot.

3. Connect the cooling fan power cable to the cooling fan connector on the system board.

Next steps

1. Install the system top cover (front).
2. Follow the procedure listed in [After working inside your system](#).

Graphics processing unit

 **NOTE:** This is a Field Replaceable Unit (FRU). Removal and installation procedures should be performed only by Dell certified service technicians.

The following are the high-level steps that you must perform to replace the GPU:

1. Remove the GPU blank.
2. Remove the GPU riser cable from the system board.
3. Remove the GPU.
4. Remove the GPU riser cable board.
5. Remove the custom GPU brackets from the GPU removed from your system.
6. Remove the GPU brackets from the replacement GPU.
7. Install the GPU brackets on the GPU removed from your system.
8. Install the custom GPU brackets on the replacement GPU.
9. Install the GPU riser cable board.
10. Install the GPU blank.
11. Install the GPU.
12. Install the GPU riser cable on the system board.

GPU installation guidelines

- The processor must be of 135 W or less.
- Due to the high power consumption of GPUs, the ambient system inlet temperature is restricted to 25°C to ensure adequate system cooling when one or more GPU cards are installed.

 **NOTE:** Certain system configurations may require reduction in the maximum ambient system inlet temperature limit. The performance of the system may be impacted when operating above the maximum temperature limit or with a faulty fan.

- All GPUs must be of the same type and model.
- You can install up to four GPUs.

 **NOTE:** Incorrect removal and installation of the GPUs will cause operational issues to your system.

Removing a GPU blank

You can remove the GPU blank only in configuration D. To remove GPU 2 in configuration D, remove the GPU blank from GPU slot 1. Do not remove GPU blanks in any other configuration.

Prerequisites



NOTE: This is a Field Replaceable Unit (FRU). Removal and installation procedures should only be done by Dell certified service technicians.



CAUTION: Many repairs may only be done by a certified service technician. You should only perform troubleshooting and simple repairs as authorized in your product documentation, or as directed by the online or telephone service and support team. Damage due to servicing that is not authorized by Dell is not covered by your warranty. Read and follow the safety instructions that came with the product.

1. Ensure that you read the [Safety instructions](#).
2. Follow the procedure listed in [Before working inside your system](#).
3. Remove the system top cover (front). For more information, see [Removing the system top cover \(front\)](#).

Steps

1. Hold the back of the GPU blank and lift it at an angle to release it from the guide pins on the front inner wall of the chassis.
2. Lift the GPU blank out of the chassis.

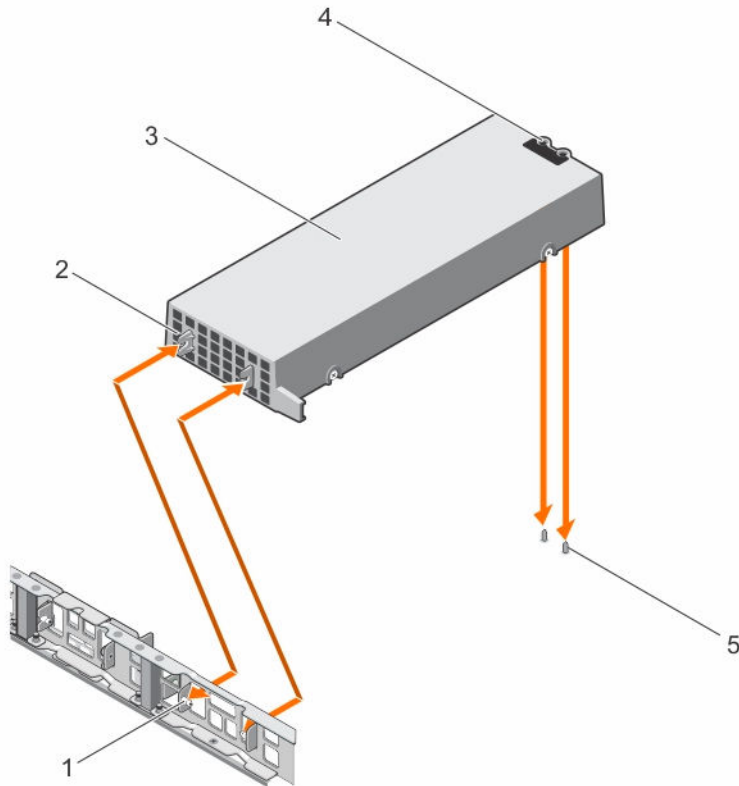

Figure 47. Removing and installing a GPU blank

- | | |
|---|---|
| 1. guide pin on the front inner wall of the chassis (2) | 2. slot on the GPU blank (2) |
| 3. GPU blank | 4. guide holes on the back of the GPU blank (2) |
| 5. guide pin on the chassis (2) | |

Removing a GPU riser cable from the system board

Prerequisites

NOTE: This is a Field Replaceable Unit (FRU). Removal and installation procedures should only be done by Dell certified service technicians.

CAUTION: Many repairs may only be done by a certified service technician. You should only perform troubleshooting and simple repairs as authorized in your product documentation, or as directed by the online or telephone service and support team. Damage due to servicing that is not authorized by Dell is not covered by your warranty. Read and follow the safety instructions that came with the product.

CAUTION: The GPU riser cables should be removed before removing the GPUs to prevent pin damage in the GPU connectors on the system board.

1. Ensure that you read the [Safety instructions](#).
2. Follow the procedure listed in [Before working inside your system](#).

Steps

1. Press the release latches located on the GPU riser cable connector on the system board.
NOTE: Pressing the release latches will not eject the GPU riser cable from the system board.
2. Pull the GPU riser cable out of the GPU riser cable connector on the system board.

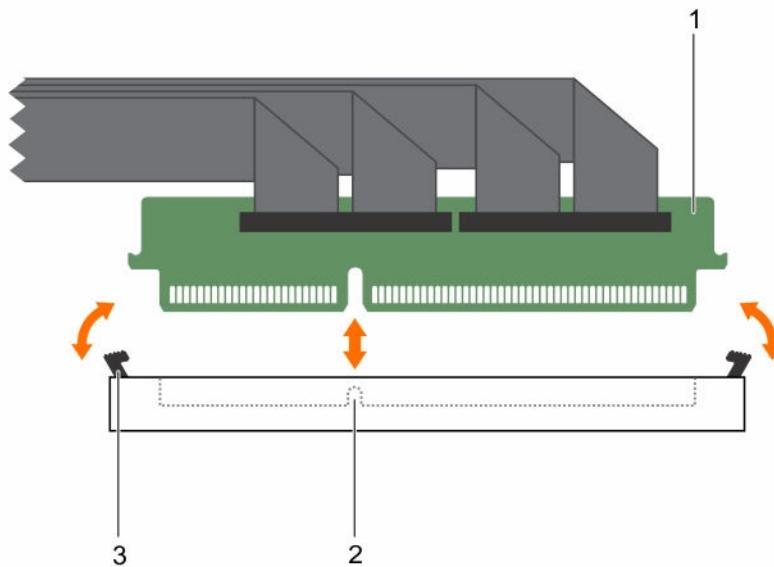

Figure 48. Removing and installing a GPU riser cable from the system board

1. riser cable connector
2. riser cable connector on the system board
3. release latch (2)

Next steps

Remove the GPU.

Related Tasks

[Removing a GPU](#)

Removing a GPU

To remove GPU 2, remove GPU 1 first and to remove GPU 4, remove GPU 3 first.

Prerequisites

- NOTE:** This is a Field Replaceable Unit (FRU). Removal and installation procedures should be performed only by Dell certified service technicians.
- CAUTION:** Many repairs may only be done by a certified service technician. You should only perform troubleshooting and simple repairs as authorized in your product documentation, or as directed by the online or telephone service and support team. Damage due to servicing that is not authorized by Dell is not covered by your warranty. Read and follow the safety instructions that came with the product.

1. Ensure that you read the [Safety instructions](#).

2. Remove the GPU riser cables connected to the switch board or system board.

CAUTION: The GPU riser cables should be removed before removing the GPUs to prevent pin damage in the GPU connectors on the system board.

3. Disconnect the power cables connected to the system board.

Steps

1. Hold the GPU by the support brackets, and lift the GPU at an angle to release it from the guide pins on the front inner wall of the chassis.

NOTE: Do not hold the GPU by the GPU riser cable board while removing the GPU.

2. Lift the GPU out of the chassis.
3. Disconnect the power cable connected to the GPU.

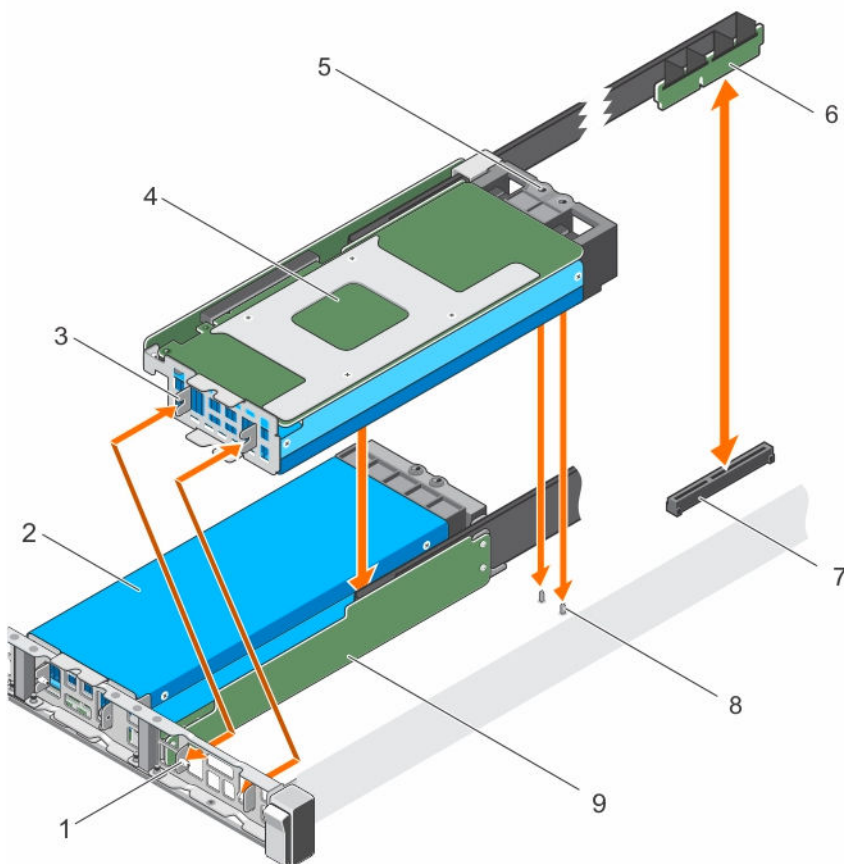

Figure 49. Removing and installing the GPU

- | | |
|---|---------------------------------|
| 1. guide pin on the front inner wall of the chassis (2) | 2. GPU 2 |
| 3. slot on the GPU I/O bracket (2) | 4. GPU 1 |
| 5. guide hole on the GPU support bracket | 6. GPU riser cable |
| 7. GPU connector on the system board or on the switch board | 8. guide pin on the chassis (2) |
| 9. GPU riser cable board | |

Next steps

Remove the GPU riser cable board.

Related Tasks

[Removing a GPU riser cable board](#)

Removing a GPU riser cable board

Prerequisites



NOTE: This is a Field Replaceable Unit (FRU). Removal and installation procedures should be performed only by Dell certified service technicians.



CAUTION: Many repairs may only be done by a certified service technician. You should only perform troubleshooting and simple repairs as authorized in your product documentation, or as directed by the online or telephone service and support team. Damage due to servicing that is not authorized by Dell is not covered by your warranty. Read and follow the safety instructions that came with the product.

1. Ensure that you read the [Safety instructions](#).
2. Keep the Philips #2 screwdriver ready.
3. Remove the GPU from the chassis. For more information, see [Removing a GPU](#).
4. Disconnect the power cables connected to the GPU.

Steps

1. Remove the screws securing the GPU riser cable board to the GPU.
2. Pull the GPU riser cable board to disengage the connector on the GPU riser cable board from the GPU.
3. Remove the GPU riser cable routed through the GPU riser cable clip.

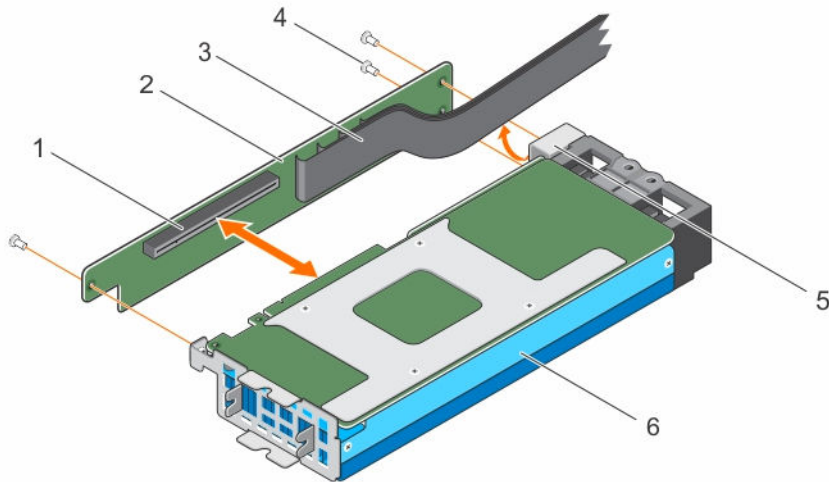

Figure 50. Removing and installing a GPU riser cable board

- | | |
|---|--------------------------|
| 1. connector on the GPU riser cable board | 2. GPU riser cable board |
| 3. GPU riser cable | 4. screw (3) |
| 5. GPU riser cable clip | 6. GPU |

Next steps

Removing the custom GPU brackets from the GPUs removed from your system.

Related Tasks

[Removing the custom GPU brackets from the GPU removed from your system](#)

Removing the custom GPU brackets from the GPU removed from your system

The Nvidia or Intel brackets are installed on the Nvidia or Intel GPUs shipped with your system. These brackets should be removed from the Nvidia or Intel GPUs removed from your system and installed on the replacement GPUs.

Prerequisites

 **NOTE:** This is a Field Replaceable Unit (FRU). Removal and installation procedures should be performed only by Dell certified service technicians.

 **CAUTION:** Many repairs may only be done by a certified service technician. You should only perform troubleshooting and simple repairs as authorized in your product documentation, or as directed by the online or telephone service and support team. Damage due to servicing that is not authorized by Dell is not covered by your warranty. Read and follow the safety instructions that came with the product.

1. Ensure that you read the [Safety instructions](#).
2. Keep the Philips #1 and #2 screwdrivers ready.

3. Remove the GPU riser cable board. For more information, see [Removing a GPU riser cable board](#).

NOTE: Depending on the type of Nvidia GPUs supported on your system, the location of the screws and type of GPU brackets will vary.

Steps

1. Remove the screws securing the front I/O bracket to the GPU, and remove the I/O bracket.
2. Remove the screws securing the support bracket to the GPU, and remove the support bracket.

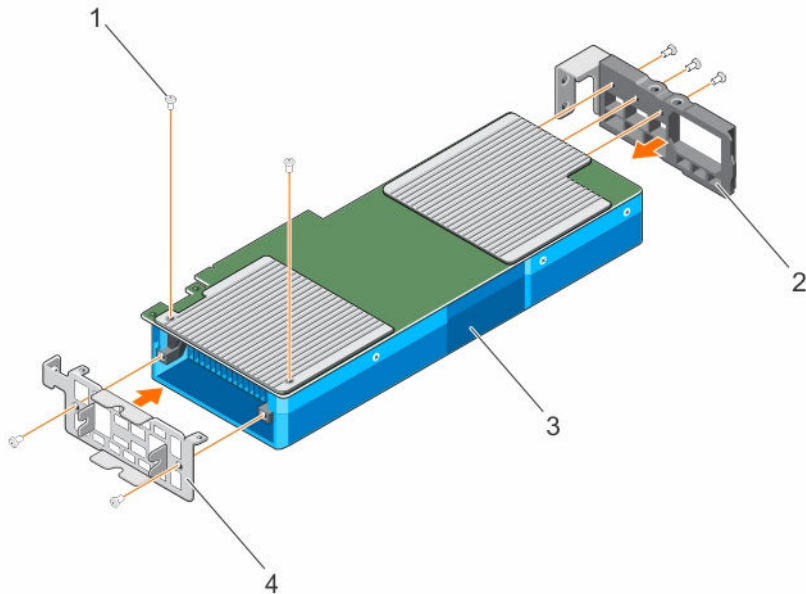

Figure 51. Removing and installing the custom Nvidia GPU I/O brackets and the support brackets

- | | |
|--------------|--------------------|
| 1. screw (7) | 2. support bracket |
| 3. GPU | 4. I/O bracket |

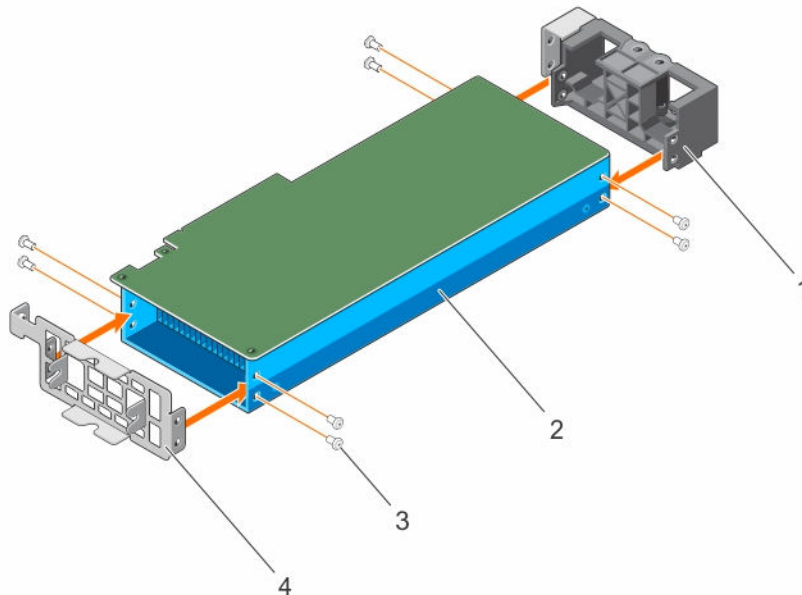

Figure 52. Removing and installing the custom Intel GPU I/O brackets and the support brackets

- | | |
|--------------------|----------------|
| 1. support bracket | 2. GPU |
| 3. screw (8) | 4. I/O bracket |

Next steps

Remove the GPU brackets from the replacement GPUs.



Related Tasks

[Removing the GPU brackets from the replacement GPUs](#)

Removing the GPU brackets from the replacement GPUs

The Nvidia or Intel replacement GPUs are shipped with specific Nvidia or Intel I/O and support brackets. These brackets should be removed from the replacement Nvidia or Intel GPUs and installed on the GPUs removed from your system. The procedure to remove the Nvidia and Intel brackets from the replacement GPUs is identical.

Prerequisites

-  **NOTE:** This is a Field Replaceable Unit (FRU). Removal and installation procedures should be performed only by Dell certified service technicians.
 -  **CAUTION:** Many repairs may only be done by a certified service technician. You should only perform troubleshooting and simple repairs as authorized in your product documentation, or as directed by the online or telephone service and support team. Damage due to servicing that is not authorized by Dell is not covered by your warranty. Read and follow the safety instructions that came with the product.
1. Ensure that you read the [Safety instructions](#).
 2. Keep the Philips #1, #2, and the Torx T6 screwdrivers ready.
 3. Remove the custom GPU brackets from the GPU removed from your system. For more information, see [Removing the custom GPU brackets from the GPU removed from your system](#).

Steps

1. Remove the screws securing the front I/O bracket to the GPU, and remove the I/O bracket.
2. Remove the screws securing the support bracket to the GPU, and remove the support bracket.

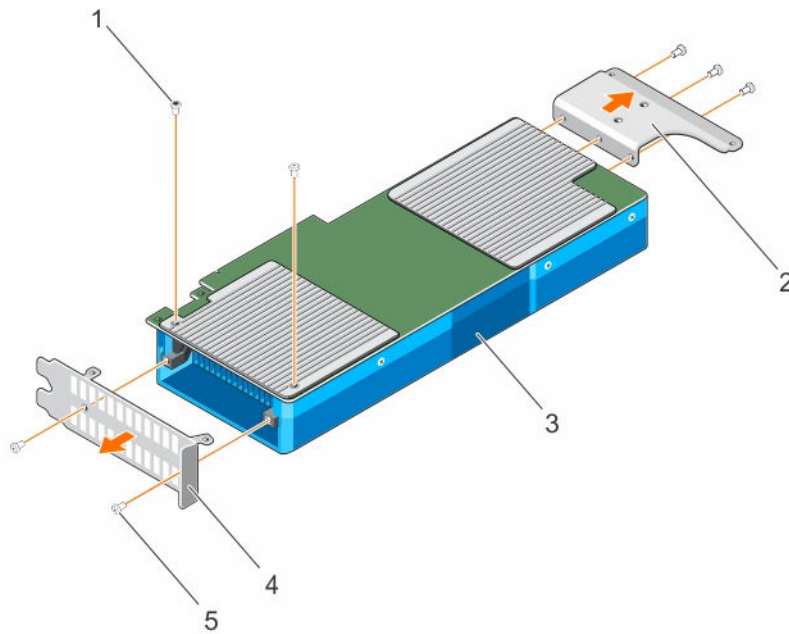

Figure 53. Removing and installing the GPU I/O brackets and the support brackets (Nvidia)

- | | |
|---------------|--------------------|
| 1. Torx screw | 2. support bracket |
| 3. GPU | 4. I/O bracket |
| 5. screw (6) | |

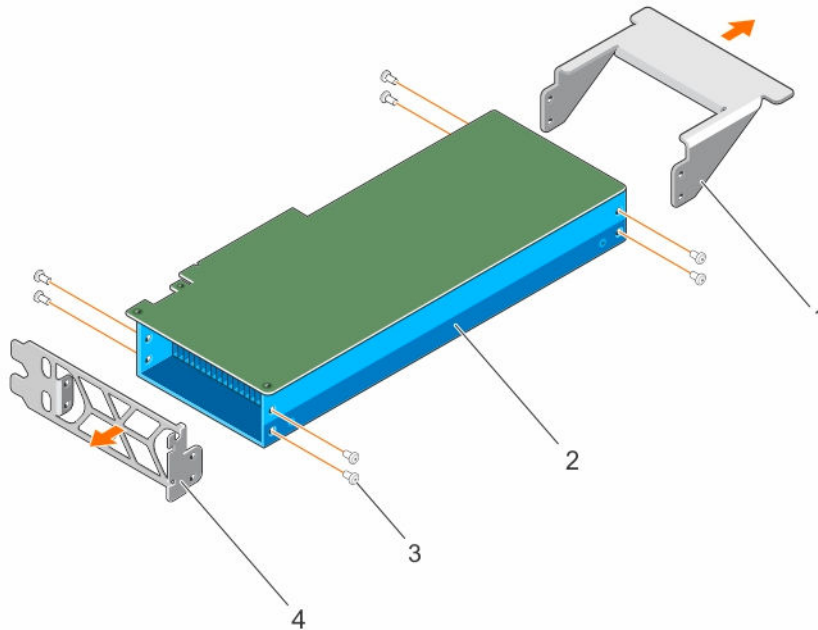

Figure 54. Removing and installing the GPU I/O brackets and the support brackets (Intel)

- | | |
|--------------------|----------------|
| 1. support bracket | 2. GPU |
| 3. screw (8) | 4. I/O bracket |

Next steps

Install the brackets on the GPU that you removed from your system.

Related Tasks

[Installing the GPU brackets on the GPU removed from your system](#)

Installing the GPU brackets on the GPU removed from your system

The Nvidia or Intel replacement GPU(s) are shipped with specific Nvidia or Intel I/O and support brackets. These brackets should be removed from the replacement Nvidia or Intel GPU(s) and installed on the GPU(s) removed from your system. The procedure to install the Nvidia or Intel brackets on the GPUs removed from your system is identical.

Prerequisites

NOTE: This is a Field Replaceable Unit (FRU). Removal and installation procedures should be performed only by Dell certified service technicians.

CAUTION: Many repairs may only be done by a certified service technician. You should only perform troubleshooting and simple repairs as authorized in your product documentation, or as directed by the online or telephone service and support team. Damage due to servicing that is not authorized by Dell is not covered by your warranty. Read and follow the safety instructions that came with the product.

1. Ensure that you read the [Safety instructions](#).
2. Keep the Phillips #1, #2, and the Torx T6 screwdrivers ready.
3. Remove the GPU brackets. For more information, see [Removing the GPU brackets from the replacement GPUs](#).

Steps

1. Align the screw holes on the front I/O bracket with the screw holes on the GPU.
2. Secure the I/O bracket to the GPU by using the screws.
3. Align the screw holes on the support bracket with the screw holes on the GPU.
4. Secure the support bracket to the GPU by using the screws.

Next steps

Install the custom GPU brackets on the replacement GPU.

Related Tasks

[Installing the custom GPU brackets on the replacement GPU](#)

Installing the custom GPU brackets on the replacement GPU

The Nvidia and Intel replacement GPUs are shipped with specific Nvidia and Intel I/O and Support brackets. These brackets should be removed from the replacement Nvidia or Intel GPU(s) and installed on the GPU(s) removed from your system. The procedure to install the custom Nvidia or Intel brackets on the replacement GPUs is identical.

Prerequisites



NOTE: This is a Field Replaceable Unit (FRU). Removal and installation procedures should be performed only by Dell certified service technicians.



CAUTION: Many repairs may only be done by a certified service technician. You should only perform troubleshooting and simple repairs as authorized in your product documentation, or as directed by the online or telephone service and support team. Damage due to servicing that is not authorized by Dell is not covered by your warranty. Read and follow the safety instructions that came with the product.

1. Ensure that you read the [Safety instructions](#).
2. Keep the Phillips #1 and #2 screwdrivers ready.
3. Install the GPU brackets on the GPU removed from your system. For more information, see [Installing the GPU brackets on the GPU removed from your system](#).

Steps

1. Align the screw holes on the front I/O bracket with the screw holes on the GPU.
2. Secure the I/O bracket to the GPU by using the screws.
3. Align the screw holes on the support bracket with the screw holes on the GPU.
4. Secure the support bracket to the GPU by using the screws.

Next steps

Install the GPU cable riser board.

Related Tasks

[Installing a GPU riser cable board](#)

Installing a GPU riser cable board

Prerequisites



NOTE: This is a Field Replaceable Unit (FRU). Removal and installation procedures should be performed only by Dell certified service technicians.

 **CAUTION:** Many repairs may only be done by a certified service technician. You should only perform troubleshooting and simple repairs as authorized in your product documentation, or as directed by the online or telephone service and support team. Damage due to servicing that is not authorized by Dell is not covered by your warranty. Read and follow the safety instructions that came with the product.

1. Ensure that you read the [Safety instructions](#).
2. Keep the Philips #2 screwdriver ready.
3. Install the custom GPU brackets on the replacement GPU. For more information, see [Installing the custom GPU brackets on the replacement GPU](#).

Steps

1. Route the riser cable through the riser cable clip.
2. Align the connector on the riser cable board with the card edge connector on the GPU and press till it clicks into place.
3. Align the screw holes on the riser cable board with the screw holes on the GPU bracket.
4. Secure the riser cable board to the GPU by using the screws.

 **NOTE:** Do not hold the GPU by the GPU riser cable board.

Next steps

1. Connect the power and data cables to the GPU.
2. Install the GPU or GPU blank.

 **CAUTION:** The GPU should be installed in the system before installing the GPU riser cables to prevent pin damage in the PCIe connectors on the system board or switch board.

Related Tasks

[Installing a GPU](#)

Installing a GPU blank

You can install the GPU blank only in configuration D. To install GPU 2, install the GPU blank in GPU slot 1.

Prerequisites

 **NOTE:** This is a Field Replaceable Unit (FRU). Removal and installation procedures should be performed only by Dell certified service technicians.

 **CAUTION:** Many repairs may only be done by a certified service technician. You should only perform troubleshooting and simple repairs as authorized in your product documentation, or as directed by the online or telephone service and support team. Damage due to servicing that is not authorized by Dell is not covered by your warranty. Read and follow the safety instructions that came with the product.

Ensure that you read the [Safety instructions](#).

Steps

1. Lower the front of the GPU blank at an angle and slide it to engage the slots on the GPU blank with the guide pins on the front inner wall of the chassis.
2. Lower the back of the GPU blank to engage the guide holes on the GPU blank with the guide pins on the chassis.

Next steps

Install GPU 2.



Related Tasks

[Installing a GPU](#)

Installing a GPU

Your system supports up to four GPUs.

Prerequisites

-  **NOTE:** This is a Field Replaceable Unit (FRU). Removal and installation procedures should be performed only by Dell certified service technicians.
 -  **CAUTION:** Many repairs may only be done by a certified service technician. You should only perform troubleshooting and simple repairs as authorized in your product documentation, or as directed by the online or telephone service and support team. Damage due to servicing that is not authorized by Dell is not covered by your warranty. Read and follow the safety instructions that came with the product.
1. Ensure that you read the [Safety instructions](#).
 2. Follow the [GPU installation guidelines](#).
 3. Install the GPU brackets. For more information, see [Installing the custom GPU brackets on the replacement GPU](#).
 4. Install the GPU riser cable board. For more information, see [Installing a GPU riser cable board](#).

Steps

1. Lower the front of the GPU at an angle and slide it to engage the slots on the GPU with the guide pins on the front inner wall of the chassis.
 -  **NOTE:** Do not hold the GPU by the GPU riser cable board.
2. Lower the back of the GPU to engage the guide holes on the GPU with the guide pins on the chassis.
3. Connect the GPU power cables to the GPU and the system board or the switch board.

Next steps

 **CAUTION:** The GPU should be installed in the system before installing the GPU riser cables to prevent pin damage in the PCIe connectors on the system board or switch board.

1. If required, install the GPU blank.
2. Install the GPU riser cable to the system board.

Related Tasks

[Installing a GPU riser cable on the system board](#)
[Installing a GPU blank](#)

Installing a GPU riser cable on the system board

Prerequisites

-  **NOTE:** This is a Field Replaceable Unit (FRU). Removal and installation procedures should be performed only by Dell certified service technicians.

 **CAUTION:** Many repairs may only be done by a certified service technician. You should only perform troubleshooting and simple repairs as authorized in your product documentation, or as directed by the online or telephone service and support team. Damage due to servicing that is not authorized by Dell is not covered by your warranty. Read and follow the safety instructions that came with the product.

1. Ensure that you read the [Safety instructions](#).
2. Install the GPU. For more information, see [Installing a GPU](#).

 **CAUTION:** The GPU should be installed in the system before installing the GPU riser cables to prevent pin damage in the PCIe connectors on the system board or switch board.

Steps

1. Align the edge connector of the riser cable with the alignment key of the riser cable connector on the system board.
2. Insert the riser cable into the riser cable connector on the system board and press till it clicks into place.
3. Close the release latches.

Next steps

Follow the procedure listed in [After working inside your system](#).

GPU cabling diagrams

Cabling configuration A and B systems

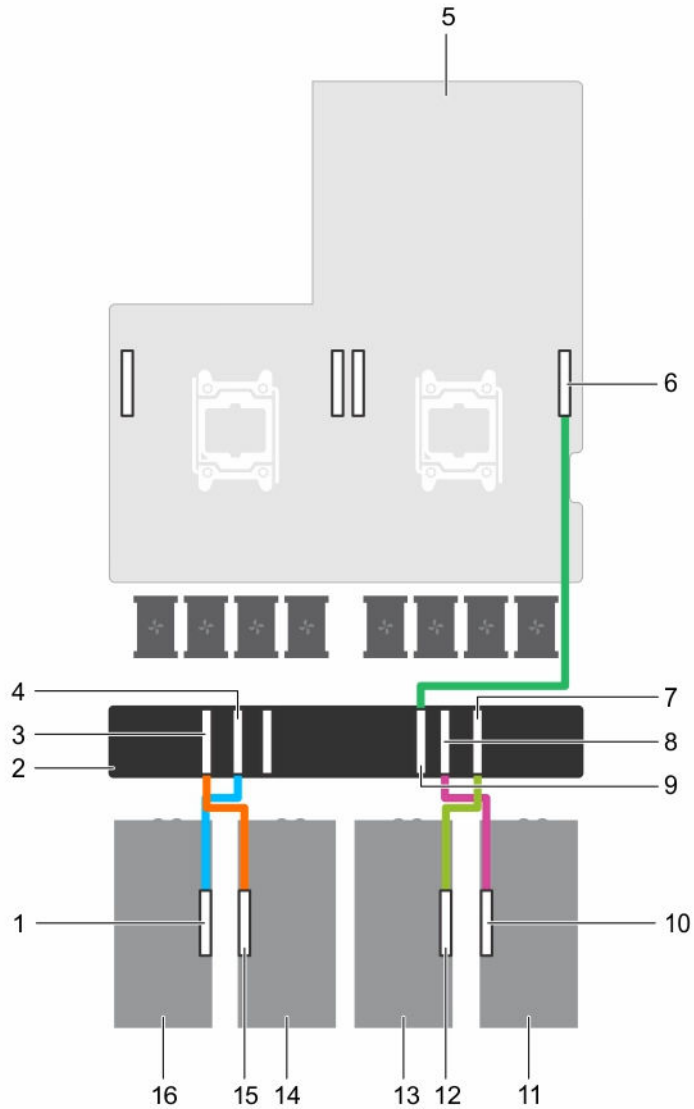

Figure 55. Cabling single and dual processor systems with four GPUs and a GPU switch board (Configurations A and B)

- | | |
|--|--|
| 1. GPU 4 riser cable connector on the GPU | 2. GPU switch board |
| 3. GPU 3 connector on the GPU switch board | 4. GPU 4 connector on the GPU switch board |
| 5. system board | 6. GPU 2 connector on the system board |
| 7. GPU 2 connector on the GPU switch board | 8. GPU 1 connector on the GPU switch board |
| 9. CPU 1 connector on the GPU switch board | 10. GPU 1 riser cable connector on the GPU |

- 11. GPU 1
- 12. GPU 2 riser cable connector on the GPU
- 13. GPU 2
- 14. GPU 3
- 15. GPU 3 riser cable connector on the GPU
- 16. GPU 4

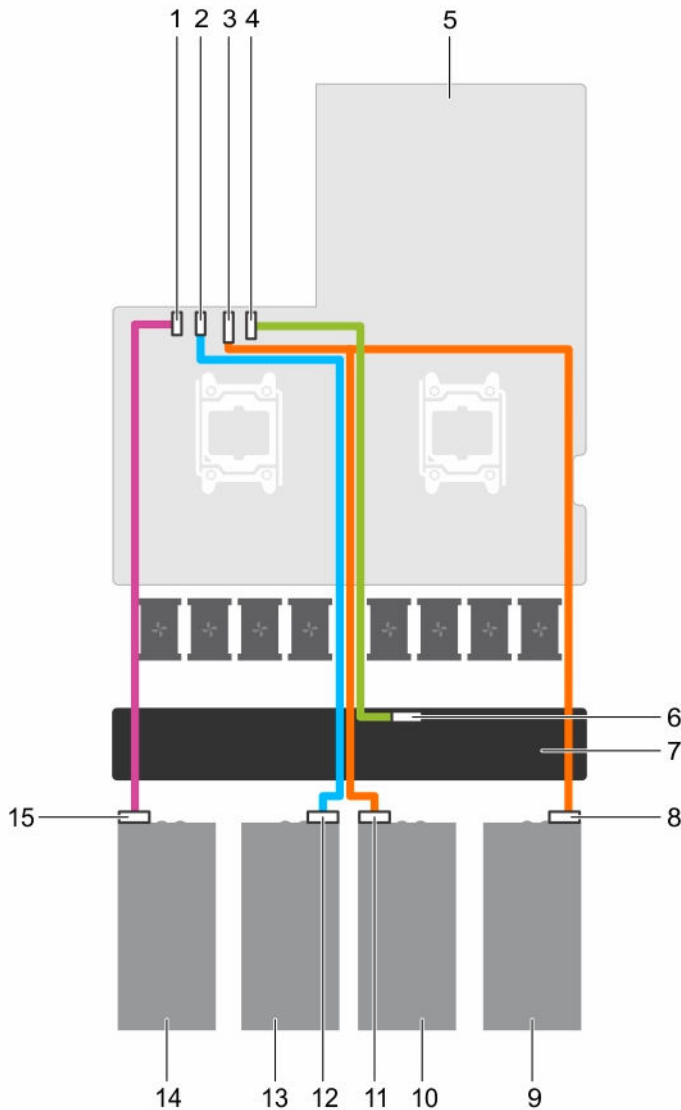

Figure 56. Power cabling for single and dual processor systems with four GPUs and a GPU switch board (Configurations A and B)

- 1. GPU 4 power connector on the system board
- 2. GPU 3 power connector on the system board
- 3. GPU 1/2 power connector on the system board
- 4. GPU switch board power connector on the system board
- 5. system board
- 6. GPU switch board power connector on the GPU switch board
- 7. GPU switch board
- 8. power connector on GPU 1

- 9. GPU 1
- 10. GPU 2
- 11. power connector on GPU 2
- 12. power connector on GPU 3
- 13. GPU 3
- 14. GPU 4
- 15. power connector on GPU 4

Cabling configuration C systems

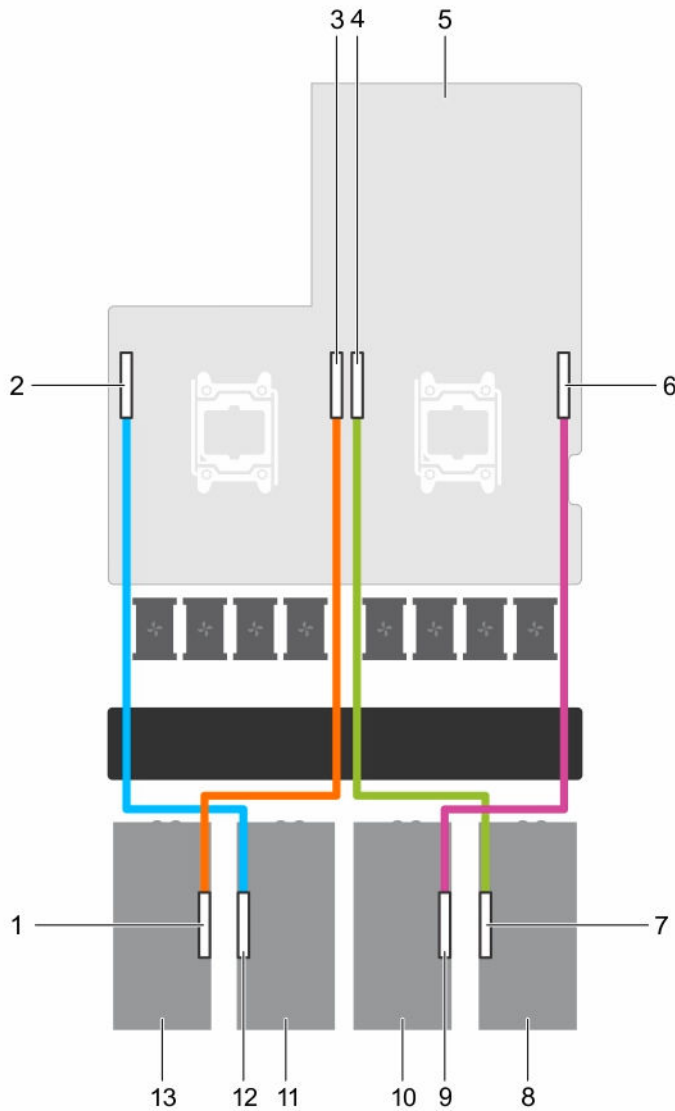

Figure 57. Cabling a dual processor system with four GPUs (Configuration C)

- 1. GPU 4 riser cable connector on the GPU
- 2. GPU 3 connector on the system board
- 3. GPU 4 connector on the system board
- 4. GPU 1 connector on the system board
- 5. system board
- 6. GPU 2 connector on the system board
- 7. GPU 1 riser cable connector on the GPU
- 8. GPU 1

- 9. GPU 2 riser cable connector on the GPU
- 10. GPU 2
- 11. GPU 3
- 12. GPU 3 riser cable connector on the GPU
- 13. GPU 4

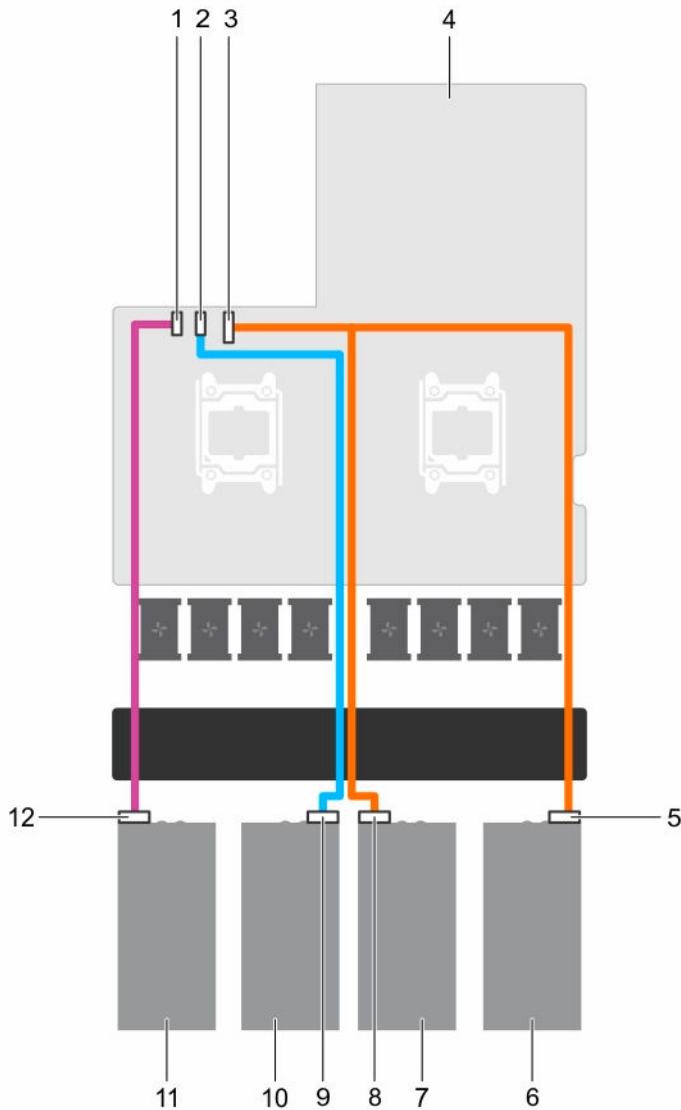

Figure 58. Power cabling for a dual processor system with four GPUs (Configuration C)

- 1. GPU 4 power connector on the system board
- 2. GPU 3 power connector on the system board
- 3. GPU 1/2 power connector on the system board
- 4. system board
- 5. power connector on GPU 1
- 6. GPU 1
- 7. GPU 2
- 8. power connector on GPU 2
- 9. power connector on GPU 3
- 10. GPU 3
- 11. GPU 4
- 12. power connector on GPU 4

Cabling configuration D systems

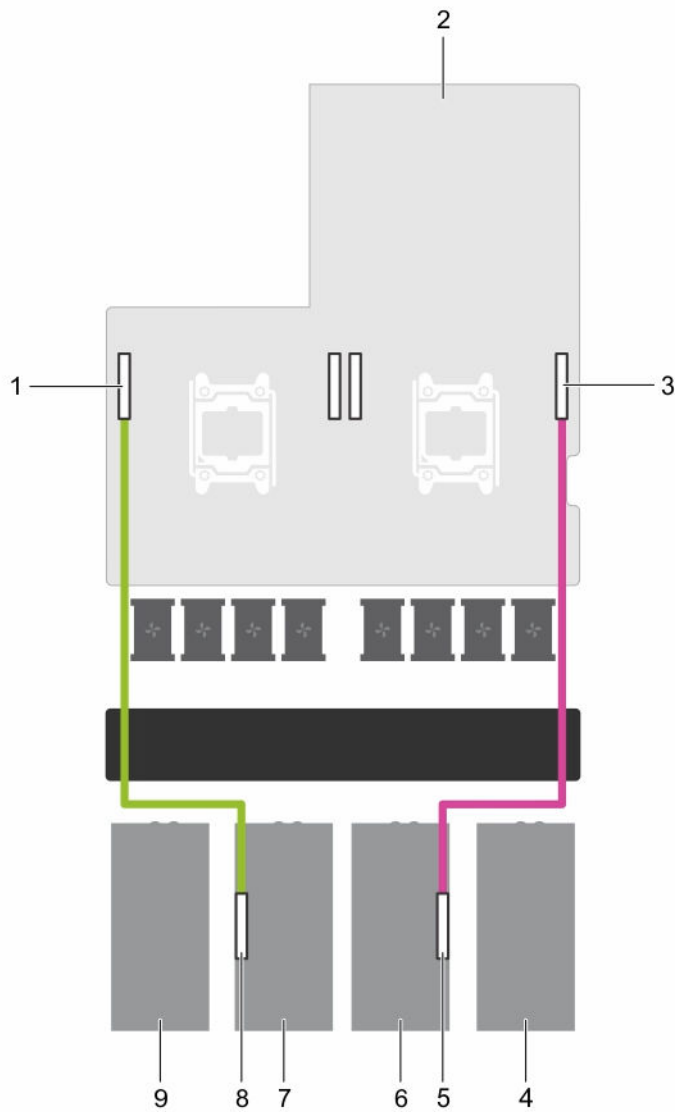

Figure 59. Cabling a dual processor system with two GPUs (Configuration D)

- | | |
|--|---|
| 1. GPU 3 riser cable connector on the system board | 2. system board |
| 3. GPU 2 connector on the system board | 4. GPU 1 blank |
| 5. GPU 2 riser cable connector on the GPU | 6. GPU 2 |
| 7. GPU 3 | 8. GPU 3 riser cable connector on the GPU |
| 9. GPU 4 blank | |

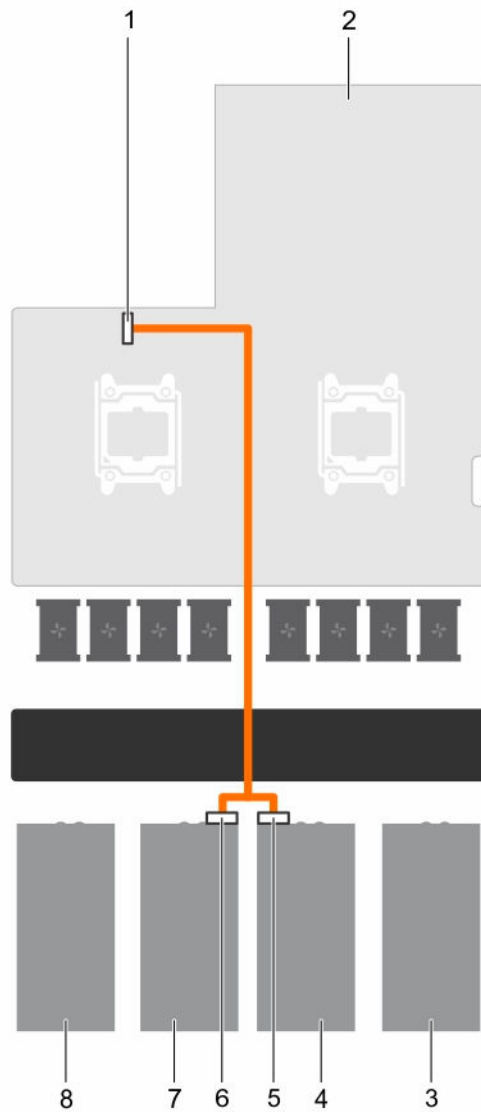

Figure 60. Power cabling for a dual processor system with two GPUs (Configuration D)

- | | |
|--|-----------------------------|
| 1. GPU 1/2 power connector on the system board | 2. system board |
| 3. GPU 1 blank | 4. GPU 2 |
| 5. power connector on GPU 2 | 6. power connector on GPU 3 |
| 7. GPU 3 | 8. GPU 4 blank |

Cabling configuration E systems

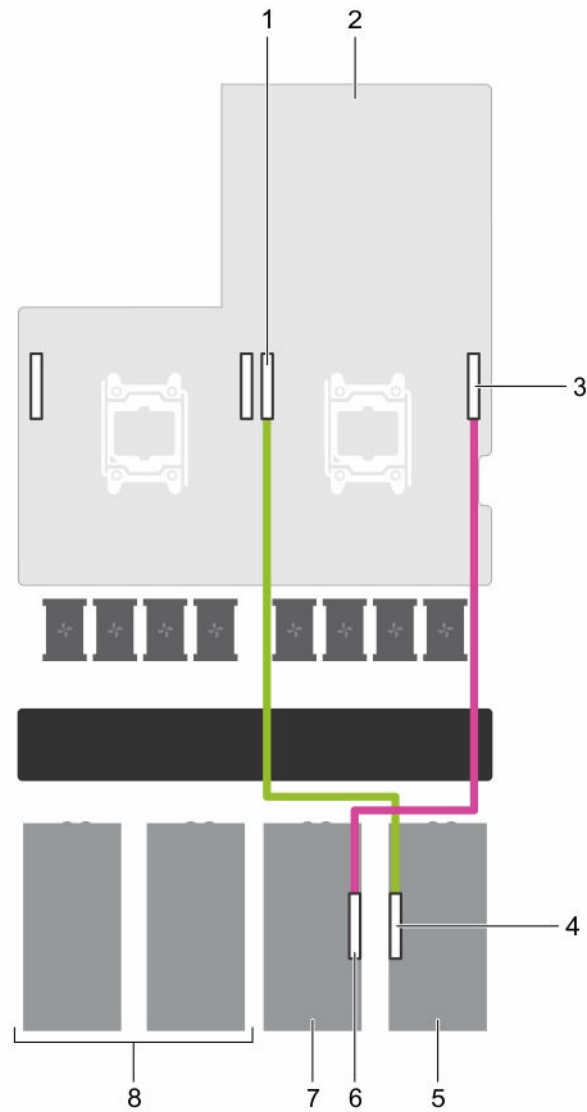

Figure 61. Cabling a single processor system with two GPUs (Configuration E)

- | | |
|--|-------------------------------|
| 1. GPU 1 connector on the system board | 2. system board |
| 3. GPU 2 connector on the system board | 4. GPU 1 connector on the GPU |
| 5. GPU 1 | 6. GPU 2 connector on the GPU |
| 7. GPU 2 | 8. GPU 3 and GPU 4 blank |

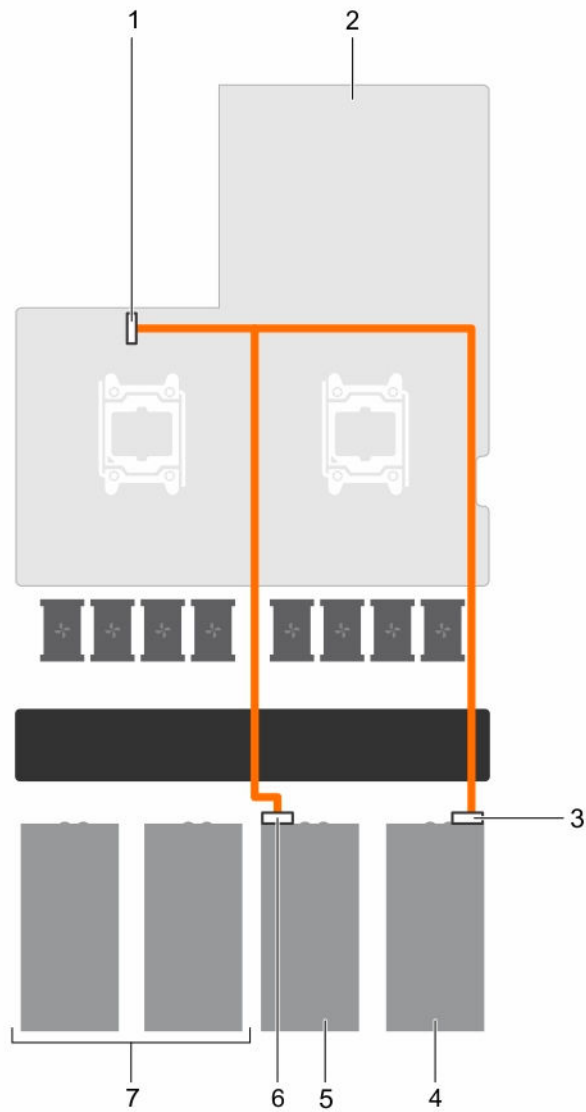

Figure 62. Power cabling for a single processor system with two GPUs (Configuration E)

- | | |
|--|-----------------------------|
| 1. GPU 1/2 power connector on the system board | 2. system board |
| 3. power connector on GPU 1 | 4. GPU 1 |
| 5. GPU 2 | 6. power connector on GPU 2 |
| 7. GPU 3 and GPU 4 blank | |

Cabling Configuration F systems

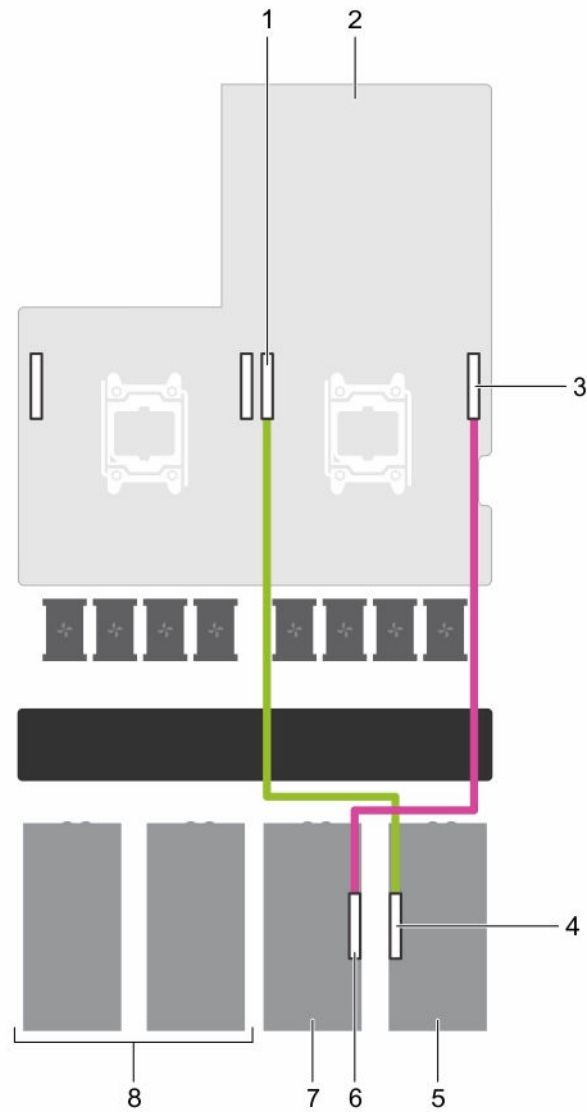

Figure 63. Cabling a dual processor system with two GPUs (Configuration F)

- | | |
|--|-------------------------------|
| 1. GPU 1 connector on the system board | 2. system board |
| 3. GPU 2 connector on the system board | 4. GPU 1 connector on the GPU |
| 5. GPU 1 | 6. GPU 2 connector on the GPU |
| 7. GPU 2 | 8. GPU 3 and GPU 4 blank |

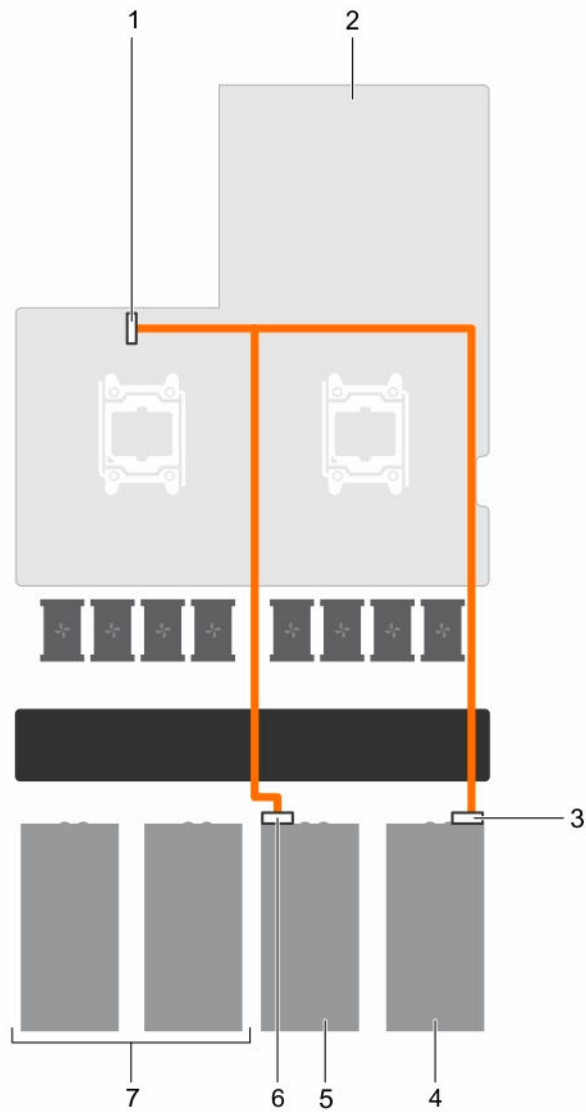

Figure 64. Power cabling for a dual processor system with two GPUs (Configuration F)

- | | | | |
|----|---|----|--------------------------|
| 1. | GPU 1/2 power connector on the system board | 2. | system board |
| 3. | power connector on GPU 1 | 4. | GPU 1 |
| 5. | GPU 2 | 6. | power connector on GPU 2 |
| 7. | GPU 3 and GPU 4 blank | | |

Cabling configuration G systems

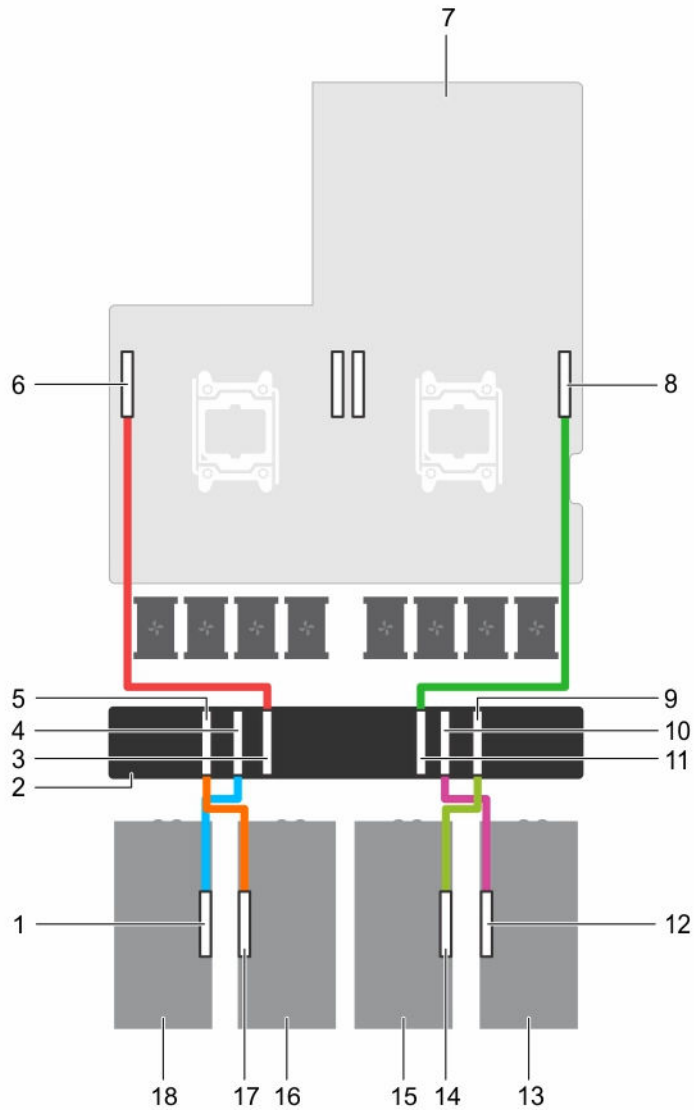

Figure 65. Cabling a dual processor system with four GPUs and a GPU switch board with dual GPU virtual mode (Configuration G)

- | | |
|---|---|
| 1. GPU 4 riser cable connector on the GPU | 2. GPU switch board |
| 3. CPU 2 connector on the GPU switch board | 4. GPU 4 connector on the GPU switch board |
| 5. GPU 3 connector on the GPU switch board | 6. GPU switch board connection to CPU 2 on the system board |
| 7. system board | 8. GPU switch board connection to CPU 1 on the system board |
| 9. GPU 2 connector on the GPU switch board | 10. GPU 1 connector on the GPU switch board |
| 11. CPU 1 connector on the GPU switch board | 12. GPU 1 riser cable connector on the GPU |

- 13. GPU 1
- 14. GPU 2 riser cable connector on the GPU
- 15. GPU 2
- 16. GPU 3
- 17. GPU 3 riser cable connector on the GPU
- 18. GPU 4

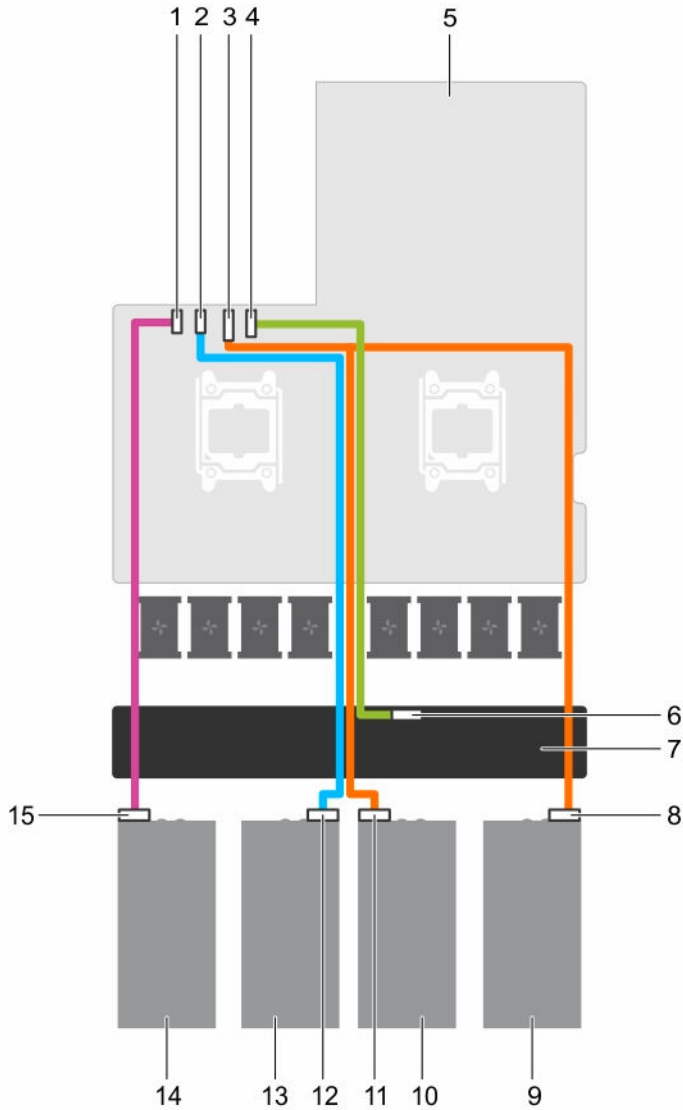

Figure 66. Power cabling for a dual processor system with four GPUs and a GPU switch board with dual GPU virtual mode (Configuration G)

- 1. GPU 4 power connector on the system board
- 2. GPU 3 power connector on the system board
- 3. GPU 1/2 power connector on the system board
- 4. GPU switch board power connector on the system board
- 5. system board
- 6. GPU switch board power connector on the GPU switch board
- 7. GPU switch board
- 8. power connector on GPU 1

- 9. GPU 1
- 10. GPU 2
- 11. power connector on GPU 2
- 12. power connector on GPU 3
- 13. GPU 3
- 14. GPU 4
- 15. power connector on GPU 4

Cabling configurations H and I

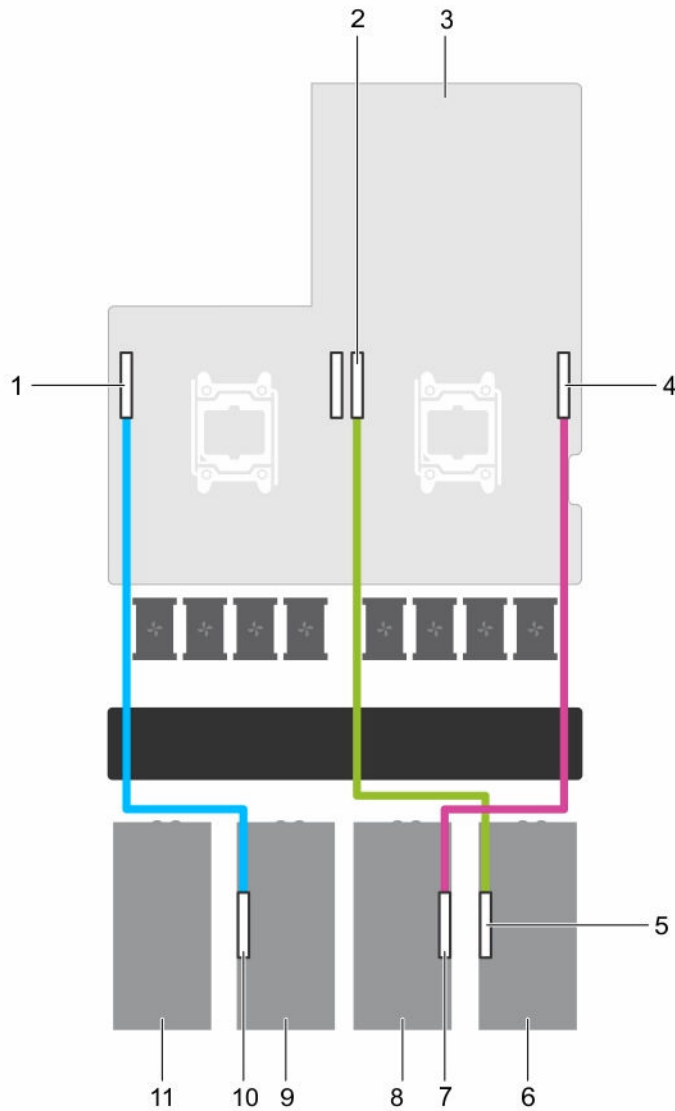

Figure 67. Cabling a dual processor system with three GPUs (Configurations H and I)

- 1. GPU 3 connector on the system board
- 2. GPU 1 connector on the system board
- 3. system board
- 4. GPU 2 connector on the system board
- 5. GPU 1 riser cable connector on GPU 1
- 6. GPU 1
- 7. GPU 2 riser cable connector on GPU 2
- 8. GPU 2

- 9. GPU 3
- 11. GPU 4 blank

- 10. GPU 3 riser cable connector on GPU 3

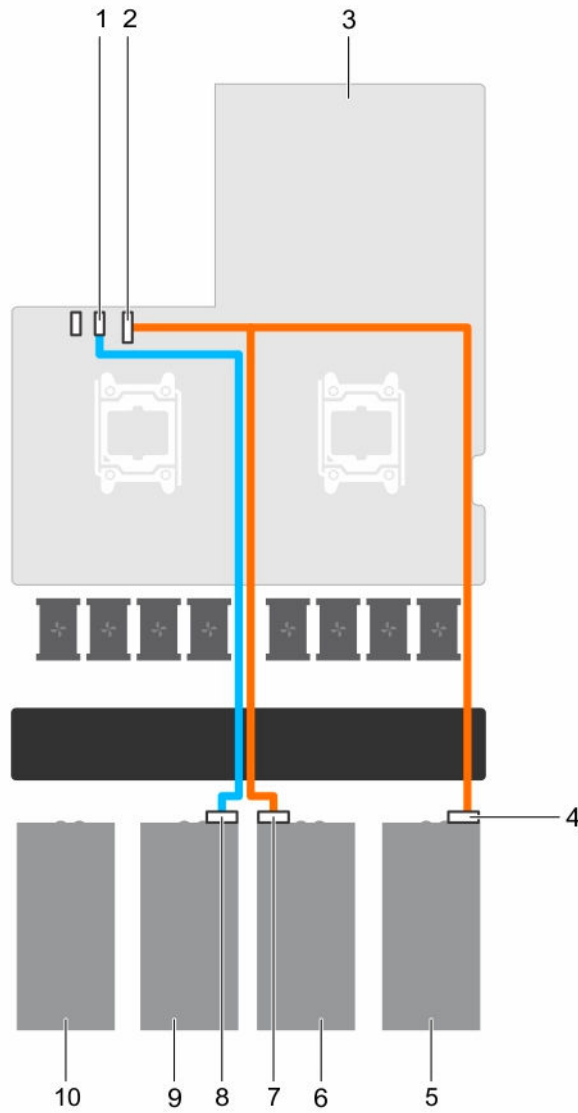



Figure 68. Power cabling for a dual processor system with three GPUs (Configurations H and I)

- | | |
|--|--|
| 1. GPU 3 power connector on the system board | 2. GPU 1/2 power connector on the system board |
| 3. system board | 4. power connector on GPU 1 |
| 5. GPU 1 | 6. GPU 2 |
| 7. power connector on GPU 2 | 8. power connector on GPU 3 |
| 9. GPU 3 | 10. GPU 4 blank |

GPU switch board (optional)

Removing the optional GPU switch board

Prerequisites

 **NOTE:** This is a Field Replaceable Unit (FRU). Removal and installation procedures should be performed only by Dell certified service technicians.

 **CAUTION:** Many repairs may only be done by a certified service technician. You should only perform troubleshooting and simple repairs as authorized in your product documentation, or as directed by the online or telephone service and support team. Damage due to servicing that is not authorized by Dell is not covered by your warranty. Read and follow the safety instructions that came with the product.

1. Ensure that you read the [Safety instructions](#).
2. Follow the procedure listed in [Before working inside your system](#).
3. Remove the system top cover (front). For more information, see [Removing the system top cover \(front\)](#).

4. Disconnect the GPU signal cables from the system board and then from the switch board.

 **NOTE:** The GPU riser signal cable should be removed from the switchboard before removing the GPUs to prevent pin damage in the GPU connectors on the switch board.

5. Remove all GPUs from the chassis. For more information, see [Removing a GPU](#).
6. Disconnect the switch board power cable.
7. Keep the Philips #2 screwdriver ready.

Steps

1. Loosen the screws securing the GPU switch board to the chassis.
2. Slide the GPU switch board toward the front of the chassis to disengage the slots on the GPU switch board from the tabs on the chassis.
3. Lift the GPU switch board out of the chassis.

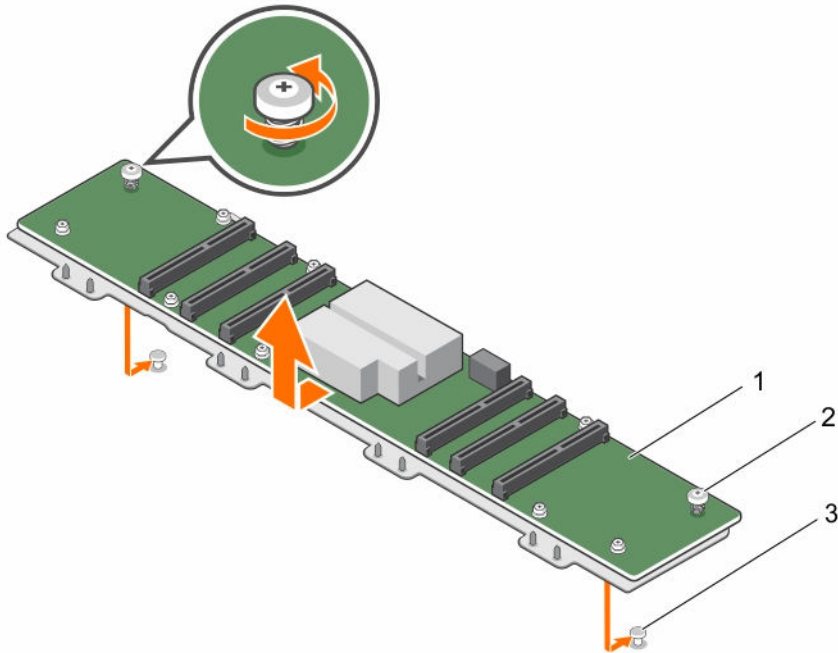

Figure 69. Removing and installing the GPU switch board

- | | |
|---------------------------|----------------------|
| 1. GPU switch board | 2. captive screw (2) |
| 3. tab on the chassis (2) | |

Next steps



1. Install the system top cover (front).
2. Follow the procedure listed in [After working inside your system](#).

Related Tasks

[Installing the system top cover \(front\)](#)

Installing the optional GPU switch board

Prerequisites

-  **NOTE:** This is a Field Replaceable Unit (FRU). Removal and installation procedures should be performed only by Dell certified service technicians.
-  **CAUTION:** Many repairs may only be done by a certified service technician. You should only perform troubleshooting and simple repairs as authorized in your product documentation, or as directed by the online or telephone service and support team. Damage due to servicing that is not authorized by Dell is not covered by your warranty. Read and follow the safety instructions that came with the product.
-  **NOTE:** The switch board used in configurations A and B is not interchangeable with the switch board used in configuration G.

1. Ensure that you read the [Safety instructions](#).
2. Follow the procedure listed in [Before working inside your system](#).

3. Keep the Philips #2 screwdriver ready.
4. Remove the GPUs. For more information, see [Removing a GPU](#).

Steps

1. Align the tabs on the chassis with the slots on the GPU switch board.
2. Slide the GPU switch board toward the back of the chassis to engage the slots on the GPU switch board with the tabs on the chassis.
3. Tighten the screws securing the switch board to the chassis.

Next steps

1. Connect the GPU switch board power cable.
2. Install the GPUs.
3. Connect the GPU signal cables to the switch board and the system board.
4. Follow the procedure listed in [After working inside your system](#).

Related References

[GPU cabling diagrams](#)



Related Tasks

[Installing a GPU](#)

Control panel module

Removing the control panel module

Prerequisites

-  **NOTE:** This is a Field Replaceable Unit (FRU). Removal and installation procedures should be performed only by Dell certified service technicians.
-  **CAUTION:** Many repairs may only be done by a certified service technician. You should only perform troubleshooting and simple repairs as authorized in your product documentation, or as directed by the online or telephone service and support team. Damage due to servicing that is not authorized by Dell is not covered by your warranty. Read and follow the safety instructions that came with the product.

1. Ensure that you read the [Safety instructions](#).
2. Follow the procedure listed in [Before working inside your system](#).
3. Keep the Phillips #1 screwdriver ready.

Steps

1. Hold and pull the plastic pull tab to disconnect the control panel cable from the control panel module.
2. Remove the screws securing the control panel module to the chassis.
3. Lift the control panel module away from the chassis.

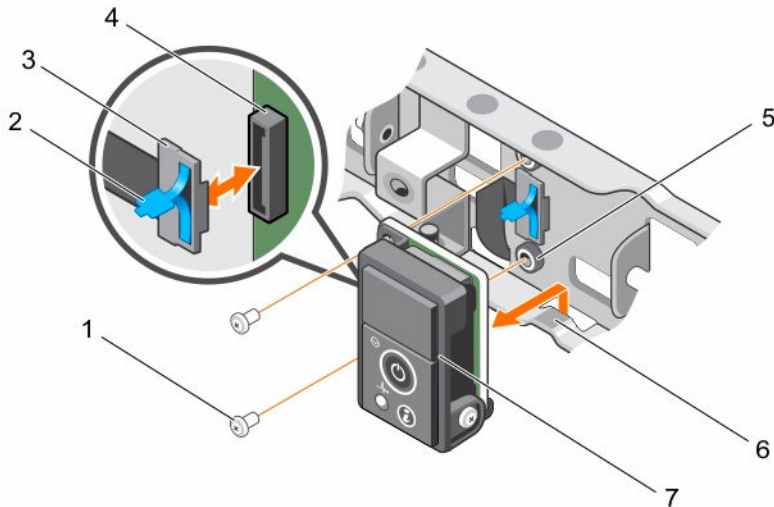

Figure 70. Removing and installing the control panel module

- | | |
|-------------------------|----------------------------|
| 1. screw (2) | 2. plastic pull tab |
| 3. control panel cable | 4. control panel connector |
| 5. control panel board | 6. notch |
| 7. control panel module | |

Next steps

1. Install the control panel module.
2. Follow the procedure listed in [After working inside your system](#).

Related Tasks

[Installing the control panel module](#)

Installing the control panel module

Prerequisites

NOTE: This is a Field Replaceable Unit (FRU). Removal and installation procedures should be performed only by Dell certified service technicians.

CAUTION: Many repairs may only be done by a certified service technician. You should only perform troubleshooting and simple repairs as authorized in your product documentation, or as directed by the online or telephone service and support team. Damage due to servicing that is not authorized by Dell is not covered by your warranty. Read and follow the safety instructions that came with the product.

1. Ensure that you read the [Safety instructions](#).
2. Follow the procedure listed in [Before working inside your system](#).
3. Keep the Phillips #1 screwdriver ready.

Steps

1. Insert the control panel module behind the notch on the chassis.
2. Align the screw holes on the control panel module with the screw holes on the chassis.
3. Secure the control panel module to the chassis by using the screws.
4. Connect the control panel cable to the control panel connector.

Next steps

Follow the procedure listed in [After working inside your system](#).

Troubleshooting your system

Safety first—for you and your system

 **CAUTION:** Many repairs may only be done by a certified service technician. You should only perform troubleshooting and simple repairs as authorized in your product documentation, or as directed by the online or telephone service and support team. Damage due to servicing that is not authorized by Dell is not covered by your warranty. Read and follow the safety instructions that came with the product.

Troubleshooting system startup failure

If you boot the system to the BIOS boot mode after installing an operating system from the UEFI Boot Manager, the system stops responding. You must boot to the same boot mode in which you installed the operating system.

For all other startup issues, note the system messages that appear on the screen.

Troubleshooting external connections

Ensure that all external cables are securely attached to the external connectors on your system before troubleshooting any external devices.

Troubleshooting the video subsystem

1. Check the power connections to the monitor.
2. Check the video interface cabling from the system to the monitor.
3. Run the appropriate diagnostic test.

If the tests run successfully, the problem is not related to video hardware.

If the tests fail, see [Getting Help](#).

Troubleshooting a USB device

About this task

Follow steps 1 to 6 to troubleshoot a USB keyboard or mouse. For other USB devices, go to step 7.

Steps

1. Disconnect the keyboard and/or mouse cables from the system and reconnect them.
2. If the problem persists, connect the keyboard and/or mouse to another USB port on the system.
3. If the problem is resolved, restart the system, enter System Setup, and check if the non-functioning USB ports are enabled.



NOTE: Older operating systems may not support USB 3.0.

4. Check if USB 3.0 is enabled in System Setup. If enabled, disable it and see if the issue is resolved.
5. In **iDRAC Settings Utility**, ensure **USB Management Port Mode** is configured as **Automatic** or **Standard OS Use**.
6. If the problem is not resolved, replace the keyboard and/or mouse with a working keyboard or mouse.
If the problem is not resolved, proceed to the next step to troubleshoot other USB devices attached to the system.
7. Turn off all attached USB devices, and disconnect them from the system.
8. Restart the system.
9. If your keyboard is functioning, enter System Setup, verify that all USB ports are enabled on the **Integrated Devices** screen.
10. Check if USB 3.0 is enabled in System Setup. If it is enabled, disable it and restart your system.
If your keyboard is not functioning, you can use remote access to enable or disable the USB options.
11. If the system is not accessible, reset the NVRAM_CLR jumper inside your system and restore the BIOS to the default settings.
12. In the **iDRAC Settings Utility**, ensure **USB Management Port Mode** is configured as **Automatic** or **Standard OS Use**.
13. Reconnect and power on each USB device one at a time.
14. If a USB device causes the same problem, turn off the device, replace the USB cable with a known good cable, and turn on the device.

Next steps

If all troubleshooting fails, see [Getting Help](#).

Troubleshooting a serial I/O device

Steps

1. Turn off the system and any peripheral devices connected to the serial port.
2. Swap the serial interface cable with a working cable, and turn on the system and the serial device.
If the problem is resolved, replace the interface cable with a known good cable.
3. Turn off the system and the serial device, and swap the serial device with a comparable device.
4. Turn on the system and the serial device.

Next steps

If the problem persists, see [Getting Help](#).

Troubleshooting a NIC

Steps

1. Run the appropriate diagnostic test. For more information, see [Using system diagnostics](#) for available diagnostic tests.
2. Restart the system and check for any system messages pertaining to the NIC controller.
3. Check the appropriate indicator on the NIC connector:
 - If the link indicator does not light, check all cable connections.
 - If the activity indicator does not light, the network driver files might be damaged or missing. Remove and reinstall the drivers if applicable. For more information, see the NIC documentation.
 - If applicable, change the autonegotiation setting.
 - Use another connector on the switch or hub.
4. Ensure that the appropriate drivers are installed and the protocols are bound. For more information, see the NIC documentation.
5. Enter System Setup and confirm that the NIC ports are enabled on the **Integrated Devices** screen.
6. Ensure that all the NICs, hubs, and switches on the network are set to the same data transmission speed and duplex. For more information, see the documentation for each network device.
7. Ensure that all network cables are of the proper type and do not exceed the maximum length.

Next steps

If all troubleshooting fails, see [Getting Help](#).

Troubleshooting a wet system

Prerequisites



CAUTION: Many repairs may only be done by a certified service technician. You should only perform troubleshooting and simple repairs as authorized in your product documentation, or as directed by the online or telephone service and support team. Damage due to servicing that is not authorized by Dell is not covered by your warranty. Read and follow the safety instructions that came with the product.

1. Turn off the system and attached peripherals, and disconnect the system from the electrical outlet.
2. Remove the system cover.

Steps

1. Remove the following components from the system:
 - Hard drives
 - GPUs
 - GPU blanks
 - GPU switch board (if present)
 - Hard drive backplane

- USB memory key
 - PCIe shroud
 - 2.5 inch hard drive cage
 - Cooling shroud
 - Expansion card risers (if present)
 - Expansion cards
 - Power supply unit(s)
 - Cooling fans
 - Processor(s) and heat sink(s)
 - Memory modules
 - Power/data cables
2. Let the system dry thoroughly for at least 24 hours.
 3. Reinstall the components (except expansion cards) you removed in step 3.
 4. Install the system cover.
 5. Turn on the system and attached peripherals.
If the system does not start properly, see [Getting Help](#).
 6. If the system starts properly, shut down the system, and reinstall all the expansion cards that you removed.
 7. Run the appropriate diagnostic test. For more information, see [Using system diagnostics](#).

Next steps

If the tests fail, see [Getting Help](#).

Troubleshooting a damaged system

Prerequisites



CAUTION: Many repairs may only be done by a certified service technician. You should only perform troubleshooting and simple repairs as authorized in your product documentation, or as directed by the online or telephone service and support team. Damage due to servicing that is not authorized by Dell is not covered by your warranty. Read and follow the safety instructions that came with the product.

Steps

1. Turn off the system and attached peripherals, and disconnect the system from the electrical outlet.
2. Remove the system top covers (front and back).
3. Ensure that the following components are properly installed:
 - Cooling shroud
 - PCIe shroud
 - Expansion card risers
 - Expansion cards
 - Power supply(s)
 - Cooling fans
 - Processor(s) and heat sink(s)
 - Memory modules

- Hard drives
 - Hard drive backplane
 - 1.8 inch hard drive cage
 - GPUs
 - GPU blanks
 - GPU switch board
 - Power and data cables
 - Riser cables
4. Ensure that all cables are properly connected.
 5. Install the system covers (front and back).
 6. Run the appropriate diagnostic test. For more information, see [Using system diagnostics](#).

Next steps

If the tests fail, see [Getting Help](#).

Troubleshooting the system battery

Prerequisites



CAUTION: Many repairs may only be done by a certified service technician. You should only perform troubleshooting and simple repairs as authorized in your product documentation, or as directed by the online or telephone service and support team. Damage due to servicing that is not authorized by Dell is not covered by your warranty. Read and follow the safety instructions that came with the product.



NOTE: If the system is turned off for long periods of time (for weeks or months), the NVRAM may lose its system configuration information. This situation is caused by a defective battery.



NOTE: Some software may cause the system time to speed up or slow down. If the system seems to operate normally except for the time set in System Setup, the problem may be caused by a software rather than by a defective battery.

Steps

1. Re-enter the time and date in System Setup.
2. Turn off the system, and disconnect it from the electrical outlet for at least one hour.
3. Reconnect the system to the electrical outlet, and turn on the system.
4. Enter System Setup.

If the date and time are not correct in System Setup, check the System Error Log (SEL) for system battery messages.

Next steps

If the problem persists, see [Getting Help](#).

Troubleshooting power supply units

 **CAUTION:** Many repairs may only be done by a certified service technician. You should only perform troubleshooting and simple repairs as authorized in your product documentation, or as directed by the online or telephone service and support team. Damage due to servicing that is not authorized by Dell is not covered by your warranty. Read and follow the safety instructions that came with the product.

Troubleshooting power source problems

1. Press the power button to ensure that your system is turned on. If the power indicator does not light up when the power button is pressed, press the power button firmly.
2. Plug in another working device to ensure that the system board is not faulty.
3. Ensure that no loose connections exist.
For example, loose power cables.
4. Ensure that the power source meets applicable standards.
5. Ensure that there are no short circuits.
6. Have a qualified electrician check the line voltage to ensure that it meets the required specifications.

Troubleshooting power supply unit problems

1. Ensure that no loose connections exist.
For example, loose power cables.
2. Ensure that the AC power source is properly connected to the PSU.
3. Ensure that the PSU handle/LED indicates that the PSU is working properly.
For more information on PSU indicators, see [Redundant power supply indicator codes](#).
4. If you have recently upgraded your system, ensure that the PSU has enough power to support the new system.
You may have to upgrade to a higher wattage power supply unit.
5. If you have a redundant PSU configuration, ensure that both the power supply units are of the same type and wattage.
6. Ensure that you use only PSUs with the Extended Power Performance (EPP) label on the back.
7. Remove and install the PSU.

 **NOTE:** After installing a PSU, allow several seconds for the system to recognize the PSU and determine if it is working properly.

If the problem persists, see [Getting Help](#).

Troubleshooting cooling problems

 **CAUTION:** Many repairs may only be done by a certified service technician. You should only perform troubleshooting and simple repairs as authorized in your product documentation, or as directed by the online or telephone service and support team. Damage due to servicing that is not authorized by Dell is not covered by your warranty. Read and follow the safety instructions that came with the product.

Ensure that the following conditions exist:

- System cover, cooling shroud, PCIe shroud, GPU blanks, PSU blank in PSU slot 2 if hard drive cage is not installed, uSATA SSD blanks if uSATA SSDs are not installed, memory module blank, or back-filler bracket is not removed.
- External airflow is not obstructed.
- A cooling fan is not removed or has not failed.
- The expansion card installation guidelines have been followed.
- Ambient air temperature is 25°C or less depending on the system configuration.

Additional cooling can be added by using one of the following methods:

From the iDRAC Web GUI

1. Click **Hardware** → **Fans** → **Setup**.
2. From the **Fan Speed Offset** drop-down list, select the cooling level needed, or set the minimum fan speed to a custom value.

From F2 System Setup

1. Select **iDRAC Settings** → **Thermal**, and set a higher fan speed from the fan speed offset or minimum fan speed.

From RACADM commands

1. Run the command `racadm help system.thermalsettings`

For more information, see the Integrated Dell Remote Access User's Guide at dell.com/esmmanuals.

Troubleshooting cooling fans

Prerequisites

 **CAUTION:** Many repairs may only be done by a certified service technician. You should only perform troubleshooting and simple repairs as authorized in your product documentation, or as directed by the online or telephone service and support team. Damage due to servicing that is not authorized by Dell is not covered by your warranty. Read and follow the safety instructions that came with the product.

 **NOTE:** In the event of a problem with a particular fan, the fan number is referenced by the system's management software, allowing you to easily identify and replace the proper fan by noting the fan numbers on the cooling fan assembly.

1. Ensure that you read the [Safety instructions](#).
2. Follow the procedure listed in [Before working inside your system](#).

Steps

1. Remove the system covers (front and back).

 **CAUTION: Do not operate the system without the system cover. This can result in overheating and cause component damage.**

2. Reseat the fan or the fan's power cable.
3. Install the system covers (front and back).
4. Restart your system.

Next steps

If the problem persists, see [Getting Help](#).

Troubleshooting system memory

Prerequisites

 **CAUTION: Many repairs may only be done by a certified service technician. You should only perform troubleshooting and simple repairs as authorized in your product documentation, or as directed by the online or telephone service and support team. Damage due to servicing that is not authorized by Dell is not covered by your warranty. Read and follow the safety instructions that came with the product.**

Steps

1. If the system is operational, run the appropriate diagnostic test. See [Using system diagnostics](#) for available diagnostic tests.
If diagnostics indicate a fault, follow the corrective actions provided by the diagnostic program.
2. If the system is not operational, turn off the system and attached peripherals, and unplug the system from the power source. Wait at least 10 seconds, and then reconnect the system to the power source.
3. Turn on the system and attached peripherals, and note the messages on the screen.
If an error message is displayed indicating a fault with a specific memory module, go to step 12.
4. Enter System Setup, and check the system memory setting. Make any changes to the memory settings, if needed.
If the memory settings match the installed memory but the problem still persists, go to step 12.
5. Turn off the system and attached peripherals, and disconnect the system from the electrical outlet.
6. Remove the system cover.
7. Check the memory channels and ensure that they are populated correctly.
 **NOTE:** See the system event log or system messages for the location of the failed memory module. Reinstall the memory device.
8. Reseat the memory modules in their sockets.
9. Install the system.
10. Enter System Setup and check the system memory setting.
If the problem is not resolved, proceed with the next step.
11. Remove the system cover.
12. If a diagnostic test or error message indicates a specific memory module as faulty, swap or replace the module with a known good memory module.

13. To troubleshoot an unspecified faulty memory module, replace the memory module in the first DIMM socket with a module of the same type and capacity.
If an error message is displayed on the screen, this may indicate a problem with the installed DIMM type(s), incorrect DIMM installation, or defective DIMM(s). Follow the on-screen instructions to resolve the problem.
14. Install the system cover.
15. As the system boots, observe any error message that is displayed and the diagnostic indicators on the front of the system.
16. If the memory problem persists, repeat step 12 through step 15 for each memory module installed.

Next steps

If the problem persists after all memory modules have been checked, see [Getting Help](#).

Troubleshooting an internal USB key

Prerequisites

 **CAUTION:** Many repairs may only be done by a certified service technician. You should only perform troubleshooting and simple repairs as authorized in your product documentation, or as directed by the online or telephone service and support team. Damage due to servicing that is not authorized by Dell is not covered by your warranty. Read and follow the safety instructions that came with the product.

Steps

1. Enter System Setup and ensure that the **USB key port** is enabled on the **Integrated Devices** screen.
2. Turn off the system and attached peripherals, and disconnect the system from the electrical outlet.
3. Remove the system cover.
4. Locate the USB key and reseal it.
5. Install the system cover.
6. Turn on the system and attached peripherals, and check if the USB key is functioning.
7. If the problem is not resolved, repeat step 2 and step 3.
8. Insert a different USB key that you know works properly.
9. Install the system cover.

Next steps

If the problem is not resolved, see [Getting Help](#).



Troubleshooting an SD card

Prerequisites

 **CAUTION:** Many repairs may only be done by a certified service technician. You should only perform troubleshooting and simple repairs as authorized in your product documentation, or as directed by the online or telephone service and support team. Damage due to servicing that is not authorized by Dell is not covered by your warranty. Read and follow the safety instructions that came with the product.

 **NOTE:** Certain SD cards have a physical write-protect switch on the card. If the write-protect switch is turned on, the SD card is not writable.

Steps

1. Enter System Setup, and ensure that the **Internal SD Card Port** is enabled.
2. Turn off the system, including any attached peripherals, and disconnect the system from the electrical outlet.
3. Remove the system cover.
 -  **NOTE:** When an SD card failure occurs, the internal dual SD module controller notifies the system. On the next restart, the system displays a message indicating the failure. If redundancy is enabled at the time of SD card failure, a critical alert will be logged and chassis health will degrade.
4. Replace the failed SD card with a new SD card.
5. Install the system cover.
6. Reconnect the system to its electrical outlet and turn the system on, including any attached peripherals.
7. Enter System Setup, and ensure that the **Internal SD Card Port** and **Internal SD Card Redundancy** modes are set to the required modes.
Verify that the correct SD slot is set as **Primary SD Card**.
8. Check if the SD card is functioning properly.
9. If the **Internal SD Card Redundancy** option is set to **Enabled** at the time of the SD card failure, the system will prompt you to perform a rebuild.
 -  **NOTE:** The rebuild will always be sourced from the primary SD card to the secondary SD card. Perform the rebuild of the SD card as necessary.

Troubleshooting a hard drive

Prerequisites

 **CAUTION:** Many repairs may only be done by a certified service technician. You should only perform troubleshooting and simple repairs as authorized in your product documentation, or as directed by the online or telephone service and support team. Damage due to servicing that is not authorized by Dell is not covered by your warranty. Read and follow the safety instructions that came with the product.

 **CAUTION:** This troubleshooting procedure can erase data stored on the hard drive. Before you proceed, back up all files on the hard drive.

Steps

1. Run the appropriate diagnostic test. For more information, see [Using system diagnostics](#).
Depending on the results of the diagnostics test, proceed as needed through the following steps.
2. If your system has a RAID controller and your hard drives are configured in a RAID array, perform the following steps:
 - a. Reboot the system and press <F10> during system startup to run the Lifecycle Controller, and then run the Hardware Configuration wizard to check the RAID configuration.
See the Lifecycle Controller documentation or online help for information on RAID configuration.
 - b. Ensure that the hard drive(s) are configured correctly for the RAID array.
 - c. Take the hard drive offline and reseat the drive.

- d. Exit the configuration utility and allow the system to boot to the operating system.
3. Ensure that the required device drivers for your controller card are installed and are configured correctly. See the operating system documentation for more information.
4. Reboot the system and enter System Setup.
5. Verify that the controller is enabled and the drives are displayed in System Setup.

Next steps

If the problem persists, try troubleshooting the expansion cards or see [Getting Help](#).

Troubleshooting a storage controller

 **CAUTION:** Many repairs may only be done by a certified service technician. You should only perform troubleshooting and simple repairs as authorized in your product documentation, or as directed by the online or telephone service and support team. Damage due to servicing that is not authorized by Dell is not covered by your warranty. Read and follow the safety instructions that came with the product.

 **NOTE:** When troubleshooting a SAS or PERC controller, see the documentation for your operating system and the controller.

1. Run the appropriate diagnostic test. For more information, see [Using system diagnostics](#).
2. Turn off the system and attached peripherals, and disconnect the system from the electrical outlet.
3. Remove the system cover.
4. Verify that the installed expansion cards are compliant with the expansion card installation guidelines.
5. Ensure that each expansion card is firmly seated in its connector.
6. Install the system cover.
7. Reconnect the system to the electrical outlet, and turn on the system and attached peripherals.
8. If the problem is not resolved, turn off the system and attached peripherals, and disconnect the system from the electrical outlet.
9. Remove the system cover.
10. Remove all expansion cards installed in the system.
11. Install the system cover.
12. Reconnect the system to the electrical outlet, and turn on the system and attached peripherals.
13. Run the appropriate diagnostic test. For more information, see [Using system diagnostics](#). If the tests fail, see [Getting Help](#).
14. For each expansion card you removed in step 10, perform the following steps:
 - a. Turn off the system and attached peripherals, and disconnect the system from the electrical outlet.
 - b. Remove the system cover.
 - c. Reinstall one of the expansion cards.
 - d. Install the system cover.
 - e. Run the appropriate diagnostic test. For more information, see [Using system diagnostics](#).

If the tests fail, see [Getting Help](#).

Troubleshooting expansion cards

Prerequisites

 **CAUTION:** Many repairs may only be done by a certified service technician. You should only perform troubleshooting and simple repairs as authorized in your product documentation, or as directed by the online or telephone service and support team. Damage due to servicing that is not authorized by Dell is not covered by your warranty. Read and follow the safety instructions that came with the product.

 **NOTE:** When troubleshooting an expansion card, see the documentation for your operating system and the expansion card.

Steps

1. Run the appropriate diagnostic test. For more information, see [Using system diagnostics](#).
2. Turn off the system and attached peripherals, and disconnect the system from the electrical outlet.
3. Remove the system cover.
4. Ensure that each expansion card is firmly seated in its connector.
5. Install the system cover.
6. If the problem is not resolved, turn off the system and attached peripherals, and disconnect the system from the electrical outlet.
7. Remove the system cover.
8. Remove all expansion cards installed in the system.
9. Install the system cover.
If the tests fail, see [Getting Help](#).
10. For each expansion card you removed in step 8, perform the following steps:
 - a. Turn off the system and attached peripherals, and disconnect the system from the electrical outlet.
 - b. Remove the system cover.
 - c. Reinstall one of the expansion cards.
 - d. Install the system cover.
 - e. Run the appropriate diagnostic test. For more information, see [Using system diagnostics](#).

Next steps

If the problem persists, see [Getting Help](#).

Troubleshooting processors

Prerequisites

 **CAUTION:** Many repairs may only be done by a certified service technician. You should only perform troubleshooting and simple repairs as authorized in your product documentation, or as directed by the online or telephone service and support team. Damage due to servicing that is not authorized by Dell is not covered by your warranty. Read and follow the safety instructions that came with the product.

Steps

1. Run the appropriate diagnostics test. See [Using system diagnostics](#) for available diagnostic tests.
2. Turn off the system and attached peripherals, and disconnect the system from the electrical outlet.
3. Remove the system cover.
4. Ensure that the processor and heat sink are properly installed.
5. Install the system cover.
6. Run the appropriate diagnostic test. For more information, see [Using system diagnostics](#).

Next steps

If the problem persists, see [Getting Help](#).

Troubleshooting a GPU

 **NOTE:** The GPU is a Field Replaceable Unit. Do not to troubleshoot the GPU without the assistance of a Dell certified service technician.

For more information, see [Getting Help](#).

 **CAUTION:** Many repairs may only be done by a certified service technician. You should only perform troubleshooting and simple repairs as authorized in your product documentation, or as directed by the online or telephone service and support team. Damage due to servicing that is not authorized by Dell is not covered by your warranty. Read and follow the safety instructions that came with the product.

System messages

For a list of event and error messages generated by the system firmware and agents that monitor system components, see the Dell Event and Error Messages Reference Guide at dell.com/esmanuals.

Warning messages

A warning message alerts you to a possible problem and prompts you to respond before the system continues a task. For example, before you format a hard drive, a message warns you that you may lose all data on the hard drive. Warning messages usually interrupt the task and require you to respond by typing y (yes) or n (no).

 **NOTE:** Warning messages are generated by either the application or the operating system. For more information, see the documentation that accompanied the operating system or application.

Diagnostic messages

The system diagnostic utilities may issue messages if you run diagnostic tests on your system. For more information about system diagnostics, see [Using system diagnostics](#).

Alert messages

The systems management software generates alert messages for your system. Alert messages include information, status, warning, and failure messages for drive, temperature, fan, and power conditions. For more information, see the systems management software documentation.

Using system diagnostics

If you experience a problem with your system, run the system diagnostics before contacting Dell for technical assistance. The purpose of running system diagnostics is to test your system hardware without requiring additional equipment or risking data loss. If you are unable to fix the problem yourself, service and support personnel can use the diagnostics results to help you solve the problem.

Dell Embedded System Diagnostics

 **NOTE:** The Dell Embedded System Diagnostics is also known as Enhanced Pre-boot System Assessment (ePSA) diagnostics.

The embedded system diagnostics provides a set of options for particular device groups or devices allowing you to:

- Run tests automatically or in an interactive mode
- Repeat tests
- Display or save test results
- Run thorough tests to introduce additional test options to provide extra information about the failed device(s)
- View status messages that inform you if tests are completed successfully
- View error messages that inform you of problems encountered during testing

When to use the Embedded System Diagnostics

If a major component or device in the system does not operate properly, running the embedded system diagnostics may indicate component failure.

Running the Embedded System Diagnostics from Boot Manager

1. As the system boots, press **<F11>**.
2. Use the up and down arrow keys to select **System Utilities** → **Launch Diagnostics**.
The **ePSA Pre-boot System Assessment** window is displayed, listing all devices detected in the system. The diagnostics starts executing the tests on all the detected devices.

Running the Embedded System Diagnostics from the Dell Lifecycle Controller

1. As the system boots, press <F11>.
2. Select **Hardware Diagnostics** → **Run Hardware Diagnostics**.
The **ePSA Pre-boot System Assessment** window is displayed, listing all devices detected in the system. The diagnostics starts executing the tests on all the detected devices.

System diagnostic controls

Menu	Description
Configuration	Displays the configuration and status information of all detected devices.
Results	Displays the results of all tests that are executed.
System health	Provides the current overview of the system performance.
Event log	Displays a time-stamped log of the results of all tests run on the system. This is displayed if at least one event description is recorded.





For information about embedded system diagnostics, see the *ePSA Diagnostics Guide (Notebooks, Desktops and Servers)* at dell.com/support/home.

Jumpers and connectors

System board jumper settings

For information on resetting the password jumper to disable a password, see [Disabling a forgotten password](#).

Table 6. System board jumper settings

Jumper	Setting	Description
PWRD_EN	 2 4 6 (default)	The password reset feature is enabled (pins 2–4). BIOS local access is unlocked at the next AC power cycle.
	 2 4 6	The password reset feature is disabled (pins 4–6).
NVRAM_CLR	 1 3 5 (default)	The configuration settings are retained at the next system boot (pins 3–5).
	 1 3 5	The configuration settings are cleared at system boot (pins 1–3).

System board connectors

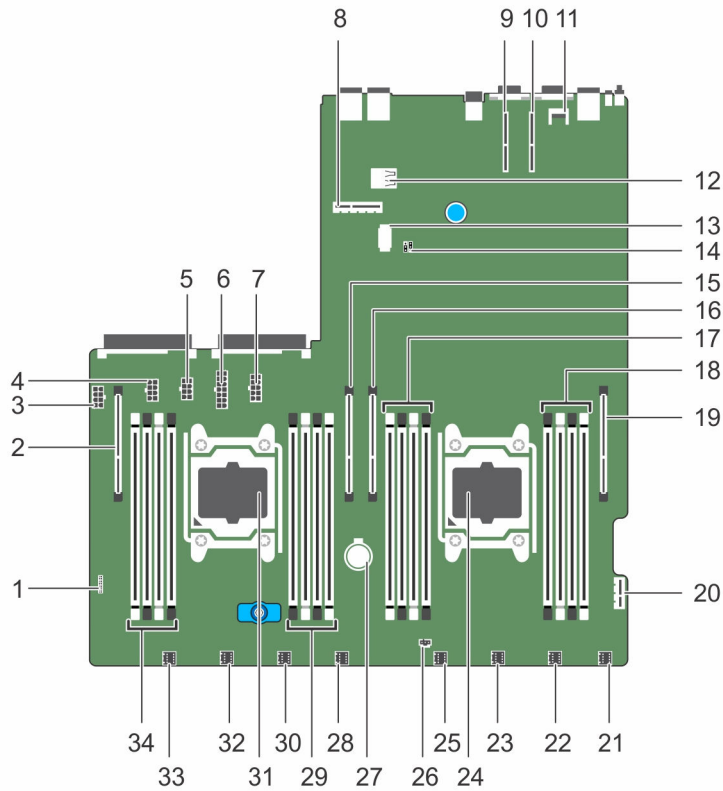

Figure 71. System board jumpers and connectors

Item	Connector	Description
1	CTRL_PNL	Front panel connector
2	GPU3 (CPU2_PE3_ABCD)	GPU 3 PCIe Connector
3	4HDD_PWR	2.5 inch hard drive cage power connector
4	GPU_4_PWR	GPU 4 power connector
5	GPU_3_PWR	GPU 3 power connector
6	GPU_1/2_PWR	GPU 1/2 power connector
7	PLX_PWR (PCIe_Switch_board)	Switch board power connector
8	2SSD_BP	1.8 inch SSD backplane connector
9	RISER_SLOT2 (CPU2_PE1_AB)	Expansion slot 2 x8 connector
10	RISER_SLOT0 (CPU1_PE1_AB)	Expansion slot 1 x8 connector
11	TPM_MODULE	Trusted Platform Module connector

Item	Connector	Description
12	USB_INT	Internal USB connector
13	4HHD_SIG	SATA x4 signal connector
14	PSWD & PSWD_NVRAM	Password jumpers
15	GPU4 (CPU2_PE2_ABCD)	GPU 4 PCIe connector
16	GPU1 (CPU1_PE3_ABCD)	GPU 1 PCIe connector
17	A3, A7, A4, A8	Memory module sockets for processor 1
18	A1, A5, A2, A6	Memory module sockets for processor 1
19	GPU2 (CPU1_PE2_ABCD)	GPU 2 PCIe connector
20	IDSDM	Internal dual SD module connector
21	FAN-1	Fan 1 connector
22	FAN-2	Fan 2 connector
23	FAN-3	Fan 3 connector
24	CPU1	Processor 1
25	FAN-4	Fan 4 connector
26	INTRUSION_CABLE	Intrusion cable connector
27	BATTERY	System battery
28	FAN-5	Fan 5 connector
29	B1, B5, B2, B6	Memory module sockets for processor 2
30	FAN-6	Fan 6 connector
31	CPU2	Processor 2
32	FAN-7	Fan 7 connector
33	FAN-8	Fan 8 connector
34	B3, B7, B4, B8	Memory module sockets for processor 2

Disabling a forgotten password

The system's software security features include a system password and a setup password. The password jumper enables these password features or disables them and clears any password(s) currently in use.

Prerequisites



CAUTION: Many repairs may only be done by a certified service technician. You should only perform troubleshooting and simple repairs as authorized in your product documentation, or as directed by the online or telephone service and support team. Damage due to servicing that is not authorized by Dell is not covered by your warranty. Read and follow the safety instructions that came with the product.

Steps

1. Turn off the system, including any attached peripherals, and disconnect the system from the electrical outlet.
2. Remove the system cover.
3. Move the jumper on the system board jumper from pins 4 and 6 to pins 2 and 4.
4. Install the system cover.



The existing passwords are not disabled (erased) until the system boots with the jumper on pins 2 and 4. However, before you assign a new system and/or setup password, you must move the jumper back to pins 4 and 6.



NOTE: If you assign a new system and/or setup password with the jumper on pins 2 and 4, the system disables the new password(s) the next time it boots.

5. Reconnect the system to its electrical outlet and turn the system on, including any attached peripherals.
6. Turn off the system, including any attached peripherals, and disconnect the system from the electrical outlet.
7. Remove the system cover.
8. Move the jumper on the system board jumper from pins 2 and 4 to pins 4 and 6.
9. Install the system cover.
10. Reconnect the system to its electrical outlet and turn the system on, including any attached peripherals.
11. Assign a new system and/or setup password.

Technical specifications

Processor	
Processor type	One or two Intel Xeon processor E5-2600 v3 product family
Power	
AC power supply (per power supply unit (PSU))	
Wattage	1100 W and 1600 W
	 NOTE: 1100 W PSUs are supported only on systems with two GPUs.
Heat dissipation	4100 BTU/hr maximum (1100 W PSU)
 NOTE: Heat dissipation is calculated using the PSU wattage rating.	5459 BTU/hr maximum (1600 W PSU)
Voltage	100–240 V AC, autoranging, 50/60 Hz for 1100 W Platinum PSU
 NOTE: This system is also designed to be connected to IT power systems with a phase-to-phase voltage not exceeding 230 V.	200–240 V AC, autoranging, 50/60 Hz, for 1600 W Platinum PSU
Expansion Bus	
Bus type	PCI Express Generation 3
Expansion cards	For a list of supported expansion cards, see Expansion card riser and expansion cards .
Expansion slots using riser card:	
Slot 1	One half-height, low-profile x8 link or One half-height, low-profile x16 link
Slot 2	One half-height, low-profile x8 link or One half-height, low-profile x16 link

Memory	
Architecture	1333 MT/s, 1600 MT/s, 1866 MT/s or 2133 MT/s DDR4 registered, Error Correcting Code (ECC) DIMMs Support for advanced ECC or memory optimized operation
Memory module sockets	Sixteen 288-pin
Memory module capacities	
RDIMMs	4 GB single-ranked, 8 GB, 16 GB, 32 GB dual- ranked
Minimum RAM	4 GB with a single processor 8 GB with a dual processor (minimum one memory module per processor)
Maximum RAM	Up to 512 GB with a dual processor Up to 256 GB with a single processor
Drives	
Hard drives	Up to four 2.5 inch SAS/SATA cabled hard drives, and up to two 1.8 inch uSATA SSDs.
Connectors	
Back	
NIC	Two 1 Gbps
Serial	9-pin, DTE, 16550-compatible
USB	Two 4-pin, USB 3.0-compliant
Video	15-pin VGA
Internal	
USB	One 4-pin, USB 3.0-compliant
Internal dual SD module	Two optional flash memory card slots with the internal dual SD module  NOTE: One card slot is dedicated for redundancy.
Video	
Video type	Matrox G200eR2
Video memory	16 MB



Physical

Height	4.31 cm (1.7 inch)
Width	43.4 cm (17.09 inch)
Length	88.58 cm (34.87 inch)
Maximum configuration weight	20.2 kg (44.53 lb)
Empty weight	12 kg (26.45 lb)

Environmental specifications

 **NOTE:** For additional information about environmental measurements for specific system configurations, see dell.com/environmental_datasheets.

Temperature

Storage	–40°C to 65°C (–40°F to 149°F)
Continuous operation (for altitude less than 950 m or 3117 ft)	10°C to 25°C (50°F to 77°F) with no direct sunlight on the equipment.  NOTE: Certain system configurations may require reductions in the upper temperature limits.  NOTE: The performance of the system may be impacted when operating above the upper temperature limit or with a faulty fan.
Maximum temperature gradient (operating and storage)	20°C/h (36°F/h)

Relative humidity

Storage	5% to 95% RH with 33°C (91°F) maximum dew point. Atmosphere must be non-condensing at all times.
Operating	10% to 80% relative humidity with 21°C (69°F) maximum dew point.

Maximum vibration

Operating	0.26 G _{rms} at 5 Hz to 350 Hz (all operation orientations).
Storage	1.88 G _{rms} at 10 Hz to 500 Hz for 15 min (all six sides tested).

Maximum shock

Operating	Six consecutively executed shock pulses in the positive and negative x, y, and z axes of 40 G for up to 2.3 ms.
Storage	Six consecutively executed shock pulses in the positive and negative x, y, and z axes (one pulse

Environmental specifications

on each side of the system) of 71 G for up to 2 ms.

Maximum altitude

Operating 3048 m (10,000 ft).

Storage 12,000 m (39,370 ft).

Operating temperature de-rating

Up to 25°C (77 °F) Maximum temperature is reduced by 1°C/300 m (1°F/547 ft) above 950 m (3,117 ft).

Particulate contamination

 **NOTE:** This section defines the limits to help avoid IT equipment damage and/or failure from particulates and gaseous contamination. If it is determined that levels of particulates or gaseous pollution are beyond the limits specified below and are the reason for the damage and/or failures to your equipment, it may be necessary for you to re-mediate the environmental conditions that are causing the damage and/or failures. Re-mediation of environmental conditions will be the responsibility of the customer.

Air filtration

Data center air filtration as defined by ISO Class 8 per ISO 14644-1 with a 95% upper confidence limit.

 **NOTE:** Applies to data center environments only. Air filtration requirements do not apply to IT equipment designed to be used outside a data center, in environments such as an office or factory floor.

 **NOTE:** Air entering the data center must have MERV11 or MERV13 filtration.

Conductive dust

Air must be free of conductive dust, zinc whiskers, or other conductive particles.

 **NOTE:** Applies to data center and non-data center environments.

Corrosive dust

- Air must be free of corrosive dust.
- Residual dust present in the air must have a deliquescent point less than 60% relative humidity.

 **NOTE:** Applies to data center and non-data center environments.

Gaseous contamination

 **NOTE:** Maximum corrosive contaminant levels measured at $\leq 50\%$ relative humidity.

Copper coupon corrosion rate <300 Å/month per Class G1 as defined by ANSI/ISA71.04-1985.

Silver coupon corrosion rate <200 Å/month as defined by AHSRAE TC9.9.

Getting help

Contacting Dell

Dell provides several online and telephone-based support and service options. If you do not have an active Internet connection, you can find contact information on your purchase invoice, packing slip, bill, or Dell product catalog. Availability varies by country and product, and some services may not be available in your area. To contact Dell for sales, technical support, or customer-service issues:

1. Go to **dell.com/support**.
2. Select your country from the drop-down menu on the bottom right corner of the page.
3. For customized support:
 - a. Enter your system Service Tag in the **Enter your Service Tag** field.
 - b. Click **Submit**.
The support page that lists the various support categories is displayed.
4. For general support:
 - a. Select your product category.
 - b. Select your product segment.
 - c. Select your product.
The support page that lists the various support categories is displayed.

Locating your system service tag

Your system is identified by a unique Express Service Code and Service Tag number. The Express Service Code and Service Tag are found on the back of the system by pulling out the information tag. Alternatively, the information may be on a sticker on the chassis of the system. This information is used by Dell to route support calls to the appropriate personnel.

Mini Express Service Tag

The Mini Express Service Tag (MEST) label which has the Service tag number of your system. It is located on top of the left rack latch. To access the MEST, the chassis will need to be pulled out of the rack about two inches.

Quick Resource Locator

Use the Quick Resource Locator (QRL) to get immediate access to system information and how-to videos. This can be done by visiting dell.com/QRL or by using your smartphone or tablet and a model specific Quick Resource (QR) code located on your Dell PowerEdge system. To try out the QR code, scan the following image.



Free Manuals Download Website

<http://myh66.com>

<http://usermanuals.us>

<http://www.somanuals.com>

<http://www.4manuals.cc>

<http://www.manual-lib.com>

<http://www.404manual.com>

<http://www.luxmanual.com>

<http://aubethermostatmanual.com>

Golf course search by state

<http://golfingnear.com>

Email search by domain

<http://emailbydomain.com>

Auto manuals search

<http://auto.somanuals.com>

TV manuals search

<http://tv.somanuals.com>