

# OWNERS MANUAL FOR TWO-STAGE AIR COMPRESSOR

## Model No. LM7580V2C

### Specification Chart

<b>Model No.</b>	<b>LM7580V2C</b>
Horsepower	7.5
Voltage/Hertz/Phase	240V/60 Hz/ 1 Ph.
Minimum Branch Circuit Requirement	30 Amp
*Fuse Type	Fusetron Type "T"
Air Tank Capacity	80 Gal. ASME
Approximate Cut-in Pressure	145 PSIG
Approximate Cut-out Pressure	175 PSIG
SCFM @ 175 PSIG	23.5
Magnetic Starter	Required (Included on Compressor)

\*A circuit breaker is preferred. Use only a fuse or circuit breaker that is the same rating as the branch circuit the air compressor is operated on. If the air compressor is connected to a circuit protected by fuses, use dual element time delay fuses (Buss Fusetron Type "T" only).

In the unlikely event you should have a problem with this product or if you are missing any parts, it is not necessary to return it to the store where you purchased it. Simply call our toll free number and talk with our Service Representative.





OUR OFFICE HOURS ARE FROM  
8 a.m. to 4:30 p.m. (CST)  
MONDAY THROUGH FRIDAY

**CALL TOLL FREE 1-800-888-2468, Ext. 2**

# TABLE OF CONTENTS

	Page		Page
<b>SAFETY GUIDELINES</b> .....	2	<b>MAINTENANCE</b> .....	13
<b>WARNING CHART</b> .....	3-4	<b>SERVICE INSTRUCTIONS</b> .....	14-17
<b>SPECIFICATIONS</b> .....	5	Air Filter-Inspection and Replacement .....	14
<b>GLOSSARY</b> .....	5	Oil-Checking and Changing .....	14
<b>DUTY CYCLE</b> .....	5	Recommended Oils .....	14
<b>GENERAL INFORMATION</b> .....	6	Check Valve-Inspection and Replacement ..	14-15
<b>ON-RECEIPT INSPECTION</b> .....	6	Safety Valve-Inspection and Replacement ..	15
<b>DESCRIPTION OF OPERATION</b> .....	7	Adjusting Belt Tension .....	16
<b>INSTALLATION AND</b>		Motor Pulley and Flywheel Alignment .....	16
<b>BREAK-IN PROCEDURES</b> .....	8-11	Additional Service .....	17
Location of Air Compressor .....	8	<b>STORAGE</b> .....	17
Air Compressor Anchoring Methods .....	8	<b>TROUBLESHOOTING GUIDE</b> .....	18-21
Wiring Instructions and Diagram .....	9	<b>COMPRESSOR DIAGRAM</b> .....	22
Voltage and Circuit Protection .....	9	<b>COMPRESSOR PARTS LIST</b> .....	23
Break-in Procedures .....	10	<b>COMPRESSOR PUMP DIAGRAM</b> .....	24
Additional Regulators and Controls .....	10	<b>PUMP PARTS LIST</b> .....	25
Lubrication and Oil .....	10	<b>AIR FILTER INSTALLATION</b> .....	26
Piping and Diagram .....	11	<b>WARRANTY STATEMENT</b> .....	27
<b>OPERATING PROCEDURES</b> .....	12	<b>HOW TO ORDER REPAIR PARTS</b> .....	Back Cover

## SAFETY GUIDELINES - DEFINITIONS

<p>This manual contains information that is important for you to know and understand. This information relates to protecting <b>YOUR SAFETY</b> and <b>PREVENTING EQUIPMENT PROBLEMS</b>. To help you recognize this information, we use symbols to the right. Please read the manual and pay attention to these sections.</p>	 <b>DANGER</b>	 <b>CAUTION</b>
	<p>URGENT SAFETY INFORMATION - A HAZARD THAT WILL CAUSE SERIOUS INJURY OR LOSS OF LIFE.</p>	<p>Information for preventing damage to equipment.</p>
	 <b>WARNING</b>	 <b>NOTE</b>
	<p>IMPORTANT SAFETY INFORMATION - A HAZARD THAT <i>MIGHT</i> CAUSE SERIOUS INJURY OR LOSS OF LIFE.</p>	<p>Information that you should pay special attention to.</p>

# IMPORTANT SAFETY INSTRUCTIONS



• SAVE THESE INSTRUCTIONS •







IMPROPER OPERATION OR MAINTENANCE OF THIS PRODUCT COULD RESULT IN SERIOUS INJURY AND PROPERTY DAMAGE. READ AND UNDERSTAND ALL WARNINGS AND OPERATING INSTRUCTIONS BEFORE USING THIS EQUIPMENT.

## ⚠ WARNING

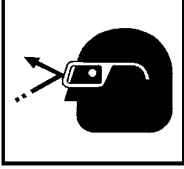

HAZARD	WHAT CAN HAPPEN	HOW TO PREVENT IT
<p><b>RISK OF BURSTING</b></p> 	<p><b>AIR TANK</b></p> <p><b>THE FOLLOWING CONDITIONS COULD LEAD TO A WEAKENING OF THE TANK, AND RESULT IN A VIOLENT TANK EXPLOSION:</b></p> <ol style="list-style-type: none"> <li><b>FAILURE TO PROPERLY DRAIN CONDENSED WATER FROM THE TANK,</b> CAUSING RUST AND THINNING OF THE STEEL TANK.</li> <li><b>MODIFICATIONS</b> OR ATTEMPTED REPAIRS <b>TO THE TANK.</b></li> <li>UNAUTHORIZED <b>MODIFICATIONS TO THE PRESSURE SWITCH, SAFETY VALVE, OR ANY OTHER COMPONENTS WHICH CONTROL TANK PRESSURE.</b></li> </ol> <p><b>ATTACHMENTS &amp; ACCESSORIES</b></p> <p><b>EXCEEDING THE PRESSURE RATING OF AIR TOOLS, SPRAY GUNS, AIR OPERATED ACCESSORIES, TIRES AND OTHER INFLATABLES CAN CAUSE THEM TO EXPLODE</b> OR FLY APART, AND COULD RESULT IN SERIOUS INJURY.</p> <p><b>EXCESSIVE VIBRATION CAN WEAKEN THE AIR TANK</b> OF A STATIONARY COMPRESSOR AND <b>CAUSE AN EXPLOSION.</b></p>	<p><b>DRAIN TANK DAILY OR AFTER EACH USE.</b> IF TANK DEVELOPS A LEAK, REPLACE IT IMMEDIATELY WITH A NEW TANK OR NEW COMPRESSOR OUTFIT.</p> <p><b>NEVER DRILL INTO, WELD, OR MAKE ANY MODIFICATIONS TO THE TANK</b> OR ITS ATTACHMENTS.</p> <p>THE TANK IS DESIGNED TO WITHSTAND SPECIFIC OPERATING PRESSURES. <b>NEVER MAKE ADJUSTMENTS OR PARTS SUBSTITUTIONS TO ALTER THE FACTORY SET OPERATING PRESSURES.</b></p> <p>FOR ESSENTIAL CONTROL OF AIR PRESSURE, YOU MUST <b>INSTALL A PRESSURE REGULATOR AND PRESSURE GAUGE TO THE AIR OUTLET</b> OF YOUR COMPRESSOR. FOLLOW THE EQUIPMENT MANUFACTURERS RECOMMENDATION AND NEVER EXCEED THE MAXIMUM ALLOWABLE PRESSURE RATING OF ATTACHMENTS. <b>NEVER USE COMPRESSOR TO INFLATE SMALL LOW-PRESSURE OBJECTS SUCH AS CHILDREN'S TOYS, FOOTBALLS, BASKETBALLS. ETC.</b></p> <p>THE <b>COMPRESSOR MUST BE PROPERLY MOUNTED.</b> SEE INSTALLATION PROCEDURES.</p>
<p><b>RISK OF EXPLOSION OR FIRE</b></p>  	<p><b>IT IS NORMAL FOR ELECTRICAL CONTACTS</b> WITHIN THE MOTOR AND PRESSURE SWITCH <b>TO SPARK.</b></p> <p><b>IF ELECTRICAL SPARKS FROM COMPRESSOR COME INTO CONTACT WITH FLAMMABLE VAPORS, THEY MAY IGNITE, CAUSING FIRE OR EXPLOSION.</b></p> <p><b>RESTRICTING ANY OF THE COMPRESSOR VENTILATION OPENINGS WILL CAUSE SERIOUS OVERHEATING AND COULD CAUSE FIRE.</b></p>	<p><b>ALWAYS OPERATE THE COMPRESSOR IN A WELL VENTILATED AREA FREE OF COMBUSTIBLE MATERIALS, GASOLINE OR SOLVENT VAPORS.</b></p> <p>IF SPRAYING FLAMMABLE MATERIALS, <b>LOCATE COMPRESSOR AT LEAST 20 FEET AWAY FROM SPRAY AREA.</b> AN ADDITIONAL LENGTH OF HOSE MAY BE REQUIRED.</p> <p><b>STORE FLAMMABLE MATERIALS IN A SECURE LOCATION AWAY FROM COMPRESSOR.</b></p> <p><b>NEVER PLACE OBJECTS AGAINST OR ON TOP OF COMPRESSOR. OPERATE COMPRESSOR IN AN OPEN AREA AT LEAST 12 INCHES AWAY FROM ANY WALL OR OBSTRUCTION</b> THAT WOULD RESTRICT THE FLOW OF FRESH AIR TO THE VENTILATION OPENINGS.</p>

CONTINUE NEXT PAGE ➔

HAZARD	WHAT CAN HAPPEN	HOW TO PREVENT IT
<p><b>RISK OF ELECTRICAL SHOCK</b></p> 	<p><u>YOUR AIR COMPRESSOR IS POWERED BY ELECTRICITY.</u> LIKE ANY OTHER ELECTRICALLY POWERED DEVICE, <u>IF IT IS NOT USED PROPERLY IT MAY CAUSE ELECTRIC SHOCK.</u></p> <p><u>REPAIRS ATTEMPTED BY UNQUALIFIED PERSONNEL CAN RESULT IN SERIOUS INJURY OR DEATH BY ELECTROCUTION.</u></p> <p>ELECTRICAL GROUNDING: <u>FAILURE TO PROVIDE ADEQUATE GROUNDING TO THIS PRODUCT COULD RESULT IN SERIOUS INJURY OR DEATH FROM ELECTROCUTION.</u> SEE GROUNDING INSTRUCTIONS.</p>	<p>NEVER OPERATE THE COMPRESSOR OUTDOORS WHEN IT IS RAINING OR IN WET CONDITIONS.</p> <p><u>NEVER OPERATE COMPRESSOR WITH COVER COMPONENTS REMOVED OR DAMAGE.</u></p> <p>ANY <u>ELECTRICAL WIRING OR REPAIRS</u> REQUIRED ON THIS PRODUCT <u>SHOULD BE PERFORMED BY AUTHORIZED SERVICE CENTER PERSONNEL</u> IN ACCORDANCE WITH NATIONAL AND LOCAL ELECTRICAL CODES.</p> <p><u>MAKE CERTAIN THAT THE ELECTRICAL CIRCUIT</u> TO WHICH THE COMPRESSOR IS CONNECTED <u>PROVIDES PROPER ELECTRICAL GROUNDING, CORRECT VOLTAGE AND ADEQUATE FUSE PROTECTION.</u></p>
<p><b>RISK FROM FLYING OBJECTS</b></p> 	<p>THE <u>COMPRESSED AIR</u> STREAM CAN CAUSE <u>SOFT TISSUE DAMAGE</u> TO EXPOSED SKIN AND CAN <u>PROPEL</u> DIRT, CHIPS, <u>LOOSE PARTICLES</u> AND SMALL OBJECTS AT <u>HIGH SPEED</u>, RESULTING IN PROPERTY DAMAGE OR PERSONAL INJURY.</p>	<p><u>ALWAYS WEAR ANSI Z87.1 APPROVED SAFETY GLASSES WITH SIDE SHIELDS</u> WHEN USING THE COMPRESSOR.</p> <p><u>NEVER POINT ANY NOZZLE OR SPRAYER TOWARD ANY PART OF THE BODY OR AT OTHER PEOPLE OR ANIMALS.</u></p> <p><u>ALWAYS TURN OFF THE COMPRESSOR, BLEED PRESSURE FROM THE AIR HOSE AND TANK, AND DISCONNECT FROM POWER SOURCE BEFORE PERFORMING MAINTENANCE OR ATTACHING TOOLS AND ACCESSORIES.</u></p>
<p><b>RISK TO BREATHING</b></p> 	<p>THE <u>COMPRESSED AIR</u> FROM YOUR COMPRESSOR <u>IS NOT SAFE FOR BREATHING!</u> THE AIR STREAM MAY CONTAIN CARBON MONOXIDE, TOXIC VAPORS OR SOLID PARTICLES.</p> <p><u>SPRAYED MATERIALS</u> SUCH AS PAINT, PAINT SOLVENTS, PAINT REMOVER, INSECTICIDES, WEED KILLERS, ETC.. <u>CONTAIN HARMFUL VAPORS</u> AND POISONS.</p>	<p><u>NEVER INHALE AIR FROM THE COMPRESSOR</u> EITHER DIRECTLY OR FROM A BREATHING DEVICE CONNECTED TO THE COMPRESSOR.</p> <p><u>WORK IN AN AREA WITH GOOD CROSS-VENTILATION.</u> READ AND <u>FOLLOW THE SAFETY INSTRUCTIONS</u> PROVIDED ON THE LABEL OR SAFETY DATA SHEETS <u>FOR THE MATERIAL YOU ARE SPRAYING.</u> <u>USE A NIOSH/MSHA APPROVED RESPIRATOR</u> DESIGNED FOR USE WITH YOUR SPECIFIC APPLICATION.</p>
<p><b>RISK FROM MOVING PARTS</b></p> 	<p>THE <u>COMPRESSOR CYCLES AUTOMATICALLY</u> WHEN THE <u>PRESSURE SWITCH IS IN THE ON/AUTO POSITION.</u></p> <p><u>MOVING PARTS CAN CAUSE SERIOUS INJURY</u> OR DAMAGE IF THEY COME INTO CONTACT WITH YOU OR YOUR CLOTHING.</p> <p><u>ATTEMPTING TO OPERATE OR REPAIR COMPRESSOR WITH PROTECTIVE SHROUDS REMOVED CAN EXPOSE YOU TO MOVING PARTS AND ELECTRICAL SHOCK.</u></p>	<p><u>ALWAYS TURN OFF THE COMPRESSOR, BLEED PRESSURE FROM THE AIR HOSE AND TANK, AND DISCONNECT FROM POWER SOURCE BEFORE PERFORMING MAINTENANCE OR ATTACHING TOOLS AND ACCESSORIES.</u></p> <p><u>DO NOT REMOVE THE PROTECTIVE COVERS</u> FROM THIS PRODUCT. <u>NEVER OPERATE THE COMPRESSOR WITH GUARDS</u> OR COVERS WHICH ARE DAMAGED OR <u>REMOVED.</u></p> <p>ANY <u>REPAIRS</u> REQUIRED ON THIS <u>PRODUCT SHOULD BE PERFORMED BY AUTHORIZED SERVICE CENTER PERSONNEL.</u></p>
<p><b>RISK OF BURNS</b></p> 	<p><u>TOUCHING EXPOSED METAL</u> SUCH AS THE COMPRESSOR HEAD OR OUTLET TUBE <u>CAN RESULT IN SERIOUS BURNS.</u></p>	<p><u>NEVER TOUCH ANY EXPOSED METAL PARTS ON COMPRESSOR</u> DURING OR IMMEDIATELY AFTER OPERATION. <u>COMPRESSOR WILL REMAIN HOT</u> FOR SEVERAL MINUTES AFTER OPERATION.</p> <p><u>DO NOT REACH AROUND PROTECTIVE SHROUDS</u> OR ATTEMPT MAINTENANCE UNTIL UNIT HAS BEEN ALLOWED TO COOL.</p>

# SPECIFICATIONS

Refer to cover page for the specifications of your compressor. Use only a fuse or circuit breaker that is the same rating as the branch circuit the air compressor is operated on. If the compressor is connected to a circuit protected by fuses, use dual element time delay fuses, as noted in specification chart.

## ⚠ CAUTION

**Improper electrical installation of this product may void its warranty and your fire insurance. Have circuit wiring performed by qualified personnel such as a licensed electrician who is familiar with the current national electric code and any prevailing local electrical codes.**

## GLOSSARY

**CFM:** Cubic feet per minute.

**SCFM:** Standard cubic feet per minute; a unit of measure of air delivery.

**PSIG:** Pounds per square inch gauge; a unit of measure of pressure.

**ASME:** American Society of Mechanical Engineers; made, tested, inspected and registered to meet the standards of the ASME.

**California Code:** Unit may comply with California Code 462 (L) (2)/(M) (2). Specification/Model Label is on the side of the tank on units that comply with California Code.

**Cut-In Pressure:** While the motor is off, air tank pressure drops as you continue to use your accessory. When the tank pressure drops to a certain low level the motor will restart automatically. The low pressure at which the motor automatically re-starts is called "cut-in pressure."

**Cut-Out Pressure:** When you turn on your air compressor and it begins to run, air pressure in the air tank begins to build. It builds to a certain high pressure before the motor automatically shuts off - protecting your air tank from pressure higher than its capacity. The high pressure at which the motor shuts off is called "cut-out pressure."

**To Lock Out Power:** Place a lock on the line power switch so no one else can turn on the power.

## DUTY CYCLE

All DeVilbiss Air Power manufactured air compressors should be operated on not more than a 50% duty cycle. This means an air compressor that pumps more than 50% of one hour, is considered misuse, because the air

compressor is undersized for the required air demand. Maximum compressor pumping time per hour is 30 minutes.

## **GENERAL INFORMATION**

You have purchased a complete compressor outfit consisting of an air compressor, air tank, electric motor, and associated controls and instruments. The outfit you have selected is a stationary model and contains a two stage air compressor pump.

Your new compressor outfit can be used for operating paint sprayers, air tools, grease guns, air brushes, caulking guns, sandblasters, inflating tires, etc.

An air pressure regulator is usually necessary for most applications. An air line filter is normally required for removal of moisture and oil vapor in compressed air when a paint spray gun is used.

An in-line lubricator is often required for air tools to prolong tool life.

Separate air transformers which combine the functions

of air regulation and/or moisture and dirt removal should be used where applicable.

A regularly scheduled program of preventive maintenance will help provide the long life that has been designed into your compressor outfit. Before operating or performing any maintenance on your compressor, refer to this manual. To keep your compressor in good working order, refer to these publications often and perform preventive maintenance steps as recommended.

## **ON-RECEIPT INSPECTION**

Each air compressor outfit is carefully checked before shipment. With improper handling, damage may result in transit and cause problems in compressor operation.

Immediately upon arrival, check equipment for both concealed and visible damages to avoid expenses being incurred to correct such problems. This should be done regardless of any visible signs of damage to the shipping container. Report any damages to carrier and arrange for inspection of goods immediately.

For the location or a listing of the nearest DeVilbiss Air Power Authorized Warranty Service Center, call our toll free number at 1-800-888-2468, Ext. 2, then 1.

# DESCRIPTION OF OPERATION

**Drain Valve:** At the base of the air tank to drain condensation at the end of each use.

**ON/AUTO-OFF Switch:** Turn this switch ON to provide automatic power to the pressure switch and OFF to remove power.

**Air Intake Filter:** This filter is designed to clean air coming into the pump. This filter must always be clean and ventilation openings free from obstructions. See "Maintenance".

**Air Compressor Pump:** In two stage compressors, air is first compressed to an intermediate pressure in the large bore cylinder, and after passing through an inter-cooler, the air is further compressed to a higher pressure in the smaller bore cylinder. This process continues until the air tank pressure reaches the factory set cutoff pressure. At that point the pressure switch shuts the electric motor off.

**Check Valve:** When the air compressor is operating, the check valve is "open", allowing compressed air to enter the air tank. When the air compressor reaches "cut-out" pressure, the check valve "closes", allowing air pressure to remain inside the air tank.

**Pressure Release Valve:** The pressure release valve located on the side of the pressure switch, is designed to automatically release compressed air from the compressor head and the outlet tube when the air compressor reaches "cut-out" pressure or is shut off. If the air is not released, the motor will try to start, but will be unable to. The pressure release valve allows the motor

to restart freely. When the motor stops running, air will be heard escaping from the valve for a few seconds. No air should be heard leaking when the motor is running.

**Pressure Switch:** The pressure switch automatically starts the motor when the air tank pressure drops below the factory set "cut-in" pressure. It stops the motor when the air tank pressure reaches the factory set "cut-out" pressure.

**Shut-off Valve:** Turn the knob counterclockwise to open the valve and clockwise to close.

**Air Tank Safety Valve:** If the pressure switch does not shut off the air compressor at its cut-out pressure setting, the safety valve will protect against high pressure by "popping off" at its factory set pressure (slightly higher than the pressure switch cut-out setting).

**Aftercooler Safety Valve:** On two stage compressor units, safety valve is provided to prevent over-pressurization of the aftercooler. The valve will protect the aftercooler by "popping off" at its factory set pressure.

**Regulator:** An air pressure regulator or a separate air transformer which combines the functions of air regulation and/or moisture and dirt removal is recommended for most applications.

**Tank Pressure Gauge:** The tank pressure gauge indicates the reserve air pressure in the tank. On outfits with no pressure regulator, this is also the pressure available at the air outlet.

# INSTALLATION AND BREAK-IN PROCEDURES

## Location of the Air Compressor

### **⚠ WARNING**

THE PUMP ASSEMBLY DOES NOT PROVIDE ADEQUATE STABILITY OR SUPPORT FOR LIFTING THE UNIT. IF THE OUTFIT MUST BE MOVED, USE THE TANK FOR LIFTING.

This compressor should be permanently mounted in place on a level floor. Operate the air compressor in a clean, dry and well ventilated area. The air intake filter must be kept clear of obstructions which could reduce air delivery of the air compressor. The air compressor should be located at least 12" away from walls or other obstructions that could interfere with the flow of air through the fan bladed flywheel. The air compressor crankcase and head are designed with fins to provide proper cooling.

The flywheel side of the outfit should be placed toward the wall and protected with a totally enclosed belt guard. In no case should the flywheel be closer than 12 to 18 inches from the wall or other obstruction that will interfere with the flow of air through the fan bladed flywheel. The area should allow space on all sides for air circulation and for ease of normal maintenance. Keep the outfit away from areas which have dirt, vapor and volatile fumes in the atmosphere which may clog and gum the intake filter and valves, causing inefficient operation. Where this is not practical a remote air intake is recommended.

### **Note**

Where a remote air intake is used, enlarge the size of the air intake piping by one pipe size for each 10 feet of length.

If humidity is high, an air filter can be installed to remove excessive moisture. Closely follow instructions packaged with the filter for proper installation. It must be installed as close as possible to the accessory.

The air compressor should be as near to air outlets as possible in order to avoid long pipe lines. Do not place the air compressor where heat is excessive.

To avoid voltage drop and power loss to the motor, use extra air hose instead of an extension cord. Low voltage can cause damage to the motor.

## Air Compressor Anchoring Methods

### **⚠ WARNING**

VIBRATION CAN WEAKEN THE AIR TANK AND CAUSE AN EXPLOSION. THE COMPRESSOR MUST BE PROPERLY MOUNTED AS ILLUSTRATED BELOW.

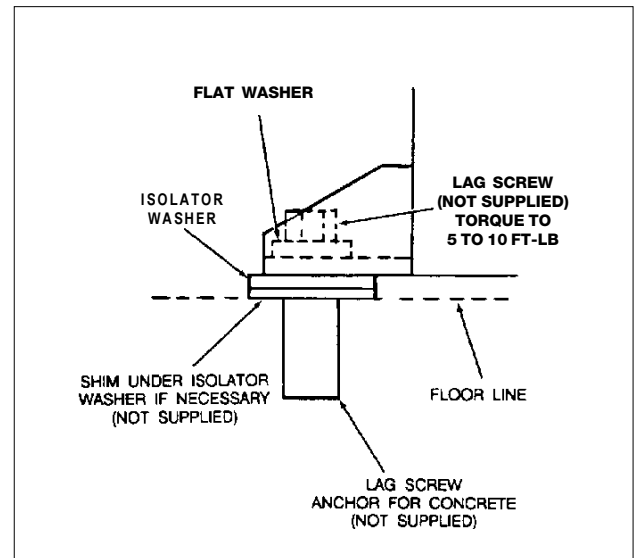

**Anchoring of Vertical Unit**

## Vertical Units

Vertical air compressors must be bolted to the floor. Bolting holes are provided in the base feet. Mount the air compressor on a solid, level foundation. Support compressor weight evenly on all four feet. Solid shims may be used if necessary.



# INSTALLATION AND BREAK-IN PROCEDURES

## Wiring Instructions

If your compressor unit is not equipped with a plug-in type power cord, perform electrical wiring according to the following instructions:

### ⚠ WARNING

**IMPROPER ELECTRICAL GROUNDING CAN RESULT IN A RISK OF ELECTRICAL SHOCK. WIRING SHOULD BE DONE BY A LICENSED ELECTRICIAN IN ACCORDANCE WITH NATIONAL AND LOCAL CODES AND ORDINANCES.**

Install the compressor outfit as close to the main power supply as possible. This practice will avoid using long lengths of electrical wiring for the power supply which can cause power loss to the motor. When connecting wires make sure that:

1. The amperage rating of the electrical box is adequate. Refer to the Specification Chart (cover page) for your air compressor outfit.
2. The supply line has the same electrical characteristics (voltage, cycle, and phase) as motor.

Wiring must be such that full motor nameplate voltage plus or minus 10%, is available at the motor terminals during starting. Refer to local codes for recommended wire sizes for correct wire size and maximum wire run; undersize wire causes high amp draw and overheating to the motor.

### ⚠ CAUTION

Electrical wiring must be located away from hot surfaces such as the compressor head, compressor cylinder, or compressor outlet tube.

## Voltage and Circuit Protection

Refer to The Specification Chart for the voltage and circuit protection requirements of your compressor. Use only a fuse or circuit breaker that is the same rating as the branch circuit the air compressor is operated on. If the compressor is connected to a circuit protected by fuses, use only dual element time delay fuses. See Specification Chart.

## Wiring of Compressor Units

**Typical Wiring of Compressor Units  
With 80 Gallons Capacity**

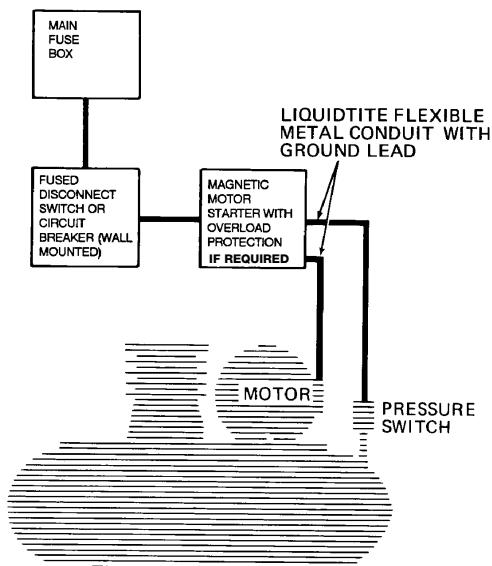

**NOTE: THESE OUTFITS DO NOT INCLUDE ANY WIRING BECAUSE OF VARIOUS INSTALLATION REQUIREMENTS.**

**Typical schematic subject to all changes as dictated by local electrical codes and authorities.**

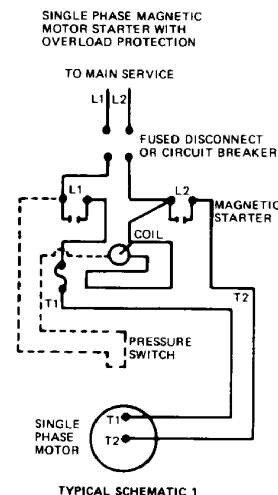

# INSTALLATION AND BREAK-IN PROCEDURES

## Break-In Procedures

### ⚠ CAUTION

**Serious damage may result if the following break-in instructions are not closely followed.**

The Break-In Procedure is required when:

- A. New compressor is put into service.
- B. Check valve is replaced
- C. New pump is installed on tank.

1. Recheck compressor wiring. Make sure wires are secure at all terminal connections. Free all contacts of loose wire cuttings, etc.
2. Open the air outlet valve fully to permit air to escape and prevent air pressure build-up in the tank during the break-in period.
3. Position the fuse disconnect or circuit breaker to the ON position and, if equipped, turn the ON/AUTO-OFF switch on the pressure switch to the ON position.
4. Run the compressor for 30 minutes. Make sure the air outlet, or globe valve, is open and there is no tank pressure build-up.
5. Check for excessive vibration and noise. Adjust air compressor belt guard as necessary to eliminate chatter. Re-adjust or shim the air compressor feet, if necessary, for proper level.
6. Close the outlet valve and let air compressor pump up to "cut-out pressure". Turn the air compressor off and check oil level. Add oil if necessary. Connect air hose to air outlet adapter.
7. Check all air line fittings and connections/piping for air leaks by applying a soap solution. Correct as necessary. Even minor leaks can cause this air compressor to overwork, resulting in premature breakdown or inadequate performance.

## Additional Regulators and Controls

Since the air tank pressure is usually greater than that which is needed, a separate regulator is usually employed to control the air pressure ahead of any individual air driven device.

Separate air transformers that combine the functions of air regulation and moisture and dirt removal should be used where applicable.

## Lubrication and Oil

### ⚠ CAUTION

**Multi-viscosity motor oils like 10W30, should not be used in an air compressor. They leave carbon deposits on critical components, thus reducing performance and compressor life. Use air compressor oil only. See page 14 for oil recommendations.**

### ⚠ CAUTION

**Compressors are shipped without oil. A small amount of oil may be present in the pump upon receipt of the air compressor. This is due to plant testing and does not mean that the pump contains oil. Do not attempt to operate in order to check wiring or for any reason without first adding oil to the crankcase. Serious damage to the pump can result from even very limited use without oil. Fill crankcase with recommended oil before operating.**

Remove the oil fill plug and fill the crankcase with recommended oil. Refer to the Service Instructions in this manual for the specific oil recommended for use in your compressor unit. Replace the oil fill plug. Always fill to middle of sight glass.

# INSTALLATION AND BREAK-IN PROCEDURES

## Piping

### CAUTION

Plastic or PVC pipe is not designed for use with compressed air. Regardless of its indicated pressure rating, plastic pipe can burst from air pressure. Use only metal pipe for air distribution lines.

#### Note

Where a remote air intake is used, enlarge the size of the air intake piping by one pipe size for each 10 feet of length.

A typical compressed air distribution system as shown below should be of sufficient pipe size to keep the pressure drop between the supply and point of use to a minimum. All pipes and fittings used must be certified safe for the pressures involved. Pipe thread sealant must be used on all threads, and all joints are to be made up tight, since small leaks in the piping system are the largest single cause of high operating costs.

All piping should be sloped to an accessible drain point and all outlets should be taken from the top of the main distribution air line so that moisture cannot enter the outlet.

The main distribution air line should not be smaller than the compressor air discharge valve outlet. A smaller line will restrict the flow of air. If piping is over 100 feet long, or if required air flow will exceed 15 SCFM, use 3/4" piping.

#### Note

For underground installation, bury air lines below the frost line and avoid pockets where condensation can gather and freeze. Apply pressure before underground lines are covered to make sure all pipe joints are free from leaks.

It is recommended that a flexible coupling be installed between the air discharge valve outlet and main air distribution line to allow for vibration.

To remove dirt, oil and water, install a separator in the main distribution line. Install separator a minimum of 5 to 6 feet from compressor to allow the air to cool to room temperature before passing through the separator. Additional separators or filters may be used depending on the application.

Liquid water occurs naturally in air lines as a result of compression. Moisture vapor in ambient air is concentrated when pressurized and condenses when cooled in downstream air piping. Compressed air dryers reduce the water vapor concentration and prevent liquid water formation in compressed air lines. Dryers are a necessary companion to filters, aftercoolers, and automatic drains for improving the productivity of compressed air systems.

Water and water vapor removal increases the efficiency of air operated equipment, reduces contamination and rusting, increases the service life of pneumatic equipment and tools, prevents air line freeze-ups, and reduces product rejects. The use of dryers and filters are recommended when these moisture related problems are reported to our factory or distributor service department.

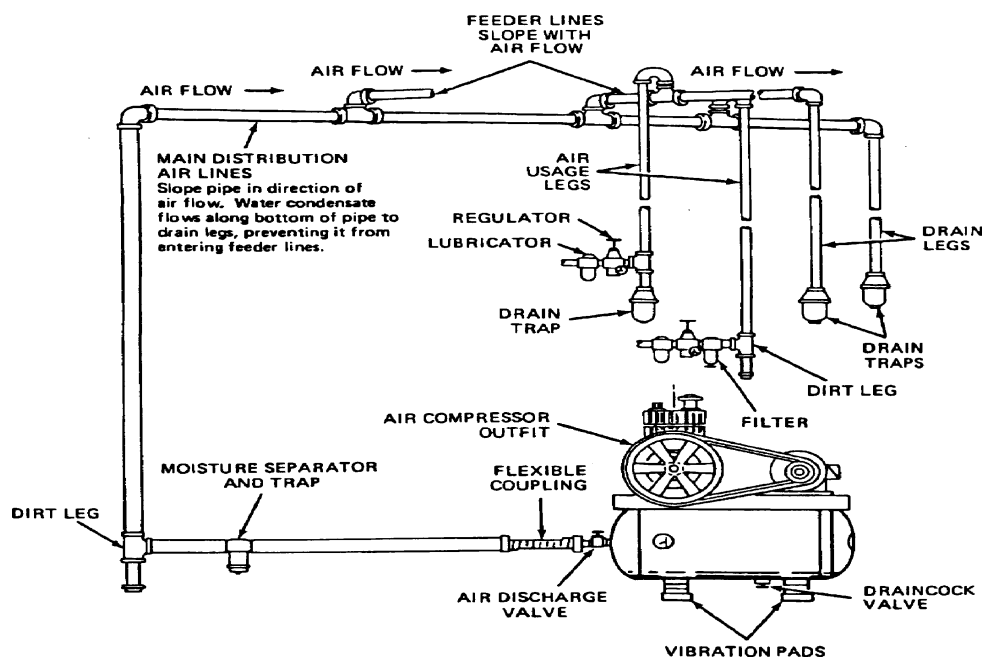

Typical Compressed Air Distribution System

# OPERATING PROCEDURES

1. Before attaching an air hose or accessory, make sure the outlet valve is in the closed position. On units equipped with a pressure switch lever make sure the switch is in the OFF position.

## ⚠ CAUTION

**Compressed air from the outfit may contain water condensation and oil mist. Do not spray unfiltered air at an item that could be damaged by moisture or oil mist. Some air operated tools or devices may require filtered air. Read instructions for air tool or device.**

2. Attach regulator, hose and accessory. On models without an air pressure regulator, one must be installed before using accessories.

## ⚠ WARNING

**TOO MUCH AIR PRESSURE CAUSES A HAZARDOUS RISK OF BURSTING. CHECK THE MANUFACTURER'S MAXIMUM PRESSURE RATING FOR AIR TOOLS AND ACCESSORIES. THE REGULATOR OUTLET PRESSURE MUST NEVER EXCEED THE MAXIMUM PRESSURE RATING.**

3. Turn the compressor on and allow tank pressure to build. On units equipped with a pressure switch lever, place the switch in the ON-AUTO position. The motor will stop when tank pressure reaches "cut-out pressure".
4. Open the outlet valve.
5. If an air pressure regulator is in use, open the regulator by turning it clockwise. Adjust the regulator to the correct pressure setting. Your outfit is ready for use.

*When You Are Finished:*

6. Turn the compressor unit off.
7. Turn the regulator counterclockwise and set the outlet pressure to zero.
8. Remove the air tool or accessory.
9. Open the regulator and allow the air to slowly bleed from the tank. Close the regulator when tank pressure is approximately 20 psi.
10. Open the drain cock valve underneath the tank and drain water from air tank. Collect the water in a suitable container. Continue operating unit until all moisture is removed from the air tank.

## ⚠ WARNING

**DRAIN TANK DAILY. WATER WILL CONDENSE IN THE AIR TANK. IF NOT DRAINED, THE WATER WILL CORRODE AND WEAKEN THE AIR TANK, CAUSING A RISK OF AIR TANK RUPTURE. THE AIR TANK MUST BE DRAINED PROPERLY.**

11. After the water has been drained, close the drain cock.
  - if the compressor is under continuous use - drain at least once each day.
  - if the compressor is only used occasionally - drain after each use.

### **Note**

If drain cock valve is clogged, release air pressure in air tank. The drain cock valve can then be removed, cleaned and reinstalled.

# MAINTENANCE

## ⚠ WARNING

**UNIT CYCLES AUTOMATICALLY WHEN POWER IS ON. DURING MAINTENANCE, YOU COULD BE EXPOSED TO VOLTAGE SOURCES, COMPRESSED AIR OR MOVING PARTS. PERSONAL INJURIES CAN OCCUR. DISCONNECT POWER SOURCE AND BLEED OFF ALL AIR TANK PRESSURE BEFORE DOING ANY MAINTENANCE OR REPAIR. NEVER OPERATE THE UNIT WITH THE BELT GUARD REMOVED.**

---

To ensure efficient operation and longer life of the air compressor outfit, a routine maintenance schedule should be prepared and followed. The following routine maintenance schedule is geared to an outfit in a normal working environment operating on a daily basis. If necessary, the schedule should be modified to suit the conditions under which your compressor is used. The modifications will depend upon the hours of operation and the working environment. Compressor outfits in an extremely dirty and/or hostile environment will require a greater frequency of all maintenance checks.

A clean air compressor runs cooler and provides longer service. Clean or blow off fins and any other parts of the air compressor that collect dust or dirt. Do not place rags, containers or other material on or against the ventilation openings in the belt guard. Adequate ventilation is necessary to maintain proper air compressor operating temperature.

## Routine Maintenance Schedule

### ***Every 8 Hours of Operation***

1. Check oil level. Add if necessary.
2. Drain water from the air tank, any moisture separators or transformers.

## ⚠ CAUTION

**Overfilling with oil will cause premature compressor failure. Do not overfill.**

3. Check for any unusual noise and/or vibration.
4. Manually check all safety valves to make sure they are operating properly.
5. Inspect for oil leaks and repair any leaks found.
6. Clean and inspect the air intake filter; replace if necessary.

### ***Every 40 Hours of Operation***

1. Inspect condition of drive belt; replace if necessary.

### ***First 100 Hours of Operation***

1. Drain and refill compressor crankcase with clean oil. Refer to Service Instructions for recommended oils.
2. Increase frequency of oil changes if humidity or operating conditions are extreme.

### ***Every 160 Hours of Operation***

1. Check drive belt tension; adjust if necessary. (Refer to SERVICE INSTRUCTIONS in this manual.)
2. Inspect air lines and fittings for leaks; correct as necessary.
3. Check the alignment of the motor pulley to the fly wheel. If necessary, align to within 1/32 inch on centerline.

### ***Every 300 Hours of Operation***

1. Drain and refill compressor crankcase with clean oil. Refer to Service Instructions for recommended oils.
2. Increase frequency of oil changes if humidity or operating conditions are extreme.

### ***Each Year of Operation (2000 Hours or if a Problem is Suspected)***

Check condition of air compressor pump intake and exhaust valves. Replace if damaged or worn out.

# SERVICE INSTRUCTIONS

## Air Filter - Inspection and Replacement

### NOTE

Keep the air filter clean at all times. Do not operate the compressor with the air filter removed.

A dirty air filter will not allow the compressor to operate at full capacity. Before you use the compressor, check the air filter to be sure it is clean. If it is dirty, replace it with a new filter.

## Oil - Checking and Changing

### CAUTION

Overfilling with oil will cause premature compressor failure. Do not overfill.

1. Check oil level in compressor crankcase before each use. The oil level should be to the middle of the oil sight glass.
2. **Replace the oil after:**  
Single - initial 100 hours of operation - thereafter, every 300 hours of operation.
3. Remove the oil fill and drain plugs. Collect the oil in a suitable container.
4. Replace the oil drain plug and refill the crankcase with recommended oil. Always fill to middle of sight glass.

### Note

It is important to maintain the proper oil level. A low oil level reduces proper cylinder wall lubrication and increases ring wear.

5. Replace the oil fill plug.
6. Start the compressor outfit and run for several minutes. Shut the compressor down and check the oil level. If necessary, add more oil.

## Oil Chart

Room or Ambient Temperature	Oil Weight	Type
Cold Climates - 10° F	20 Wt.	Reciprocating Non-detergent petroleum based compressor rated or better oil
Moderate Climates - 30° to 80° F	30 Wt.	
Hot Climates - 80° F	40 Wt.	

A compressor grade **non-detergent** oil should be used. Most automotive detergent oils cause excessive carbon buildup and should not be used. Please note that all units run at a constant speed (not start and stop) and should be lubricated by Rarus 847, Shell turbo 100, or Anderol synthetic compressor oil. **Do not** use synthetic oil for the first 300 hours. All units should be broken in on petroleum based oil.

## Check Valve - Inspection and Replacement

Remove and inspect the check valve at least once a year or more often if the compressor is heavily used. Moisture and other contaminants in the hot compressed air will cause an accumulation of a carbon-like residue on the working parts. If the valve has heavy carbon build-up, it should be replaced. Use the following procedure to inspect, clean or replace the check valve.

1. Turn compressor off and disconnect or lock out power source.
2. Release air pressure from the air tank.
3. Loosen the top and bottom tube nuts and remove the outlet tube.
4. Loosen pressure release tube nuts, disconnect from check valve and move tube aside.
5. Unscrew the check valve with a wrench.

# SERVICE INSTRUCTIONS

6. Check that the valve disc moves freely and that the spring holds the disc in the upper, closed position. The check valve may be cleaned with a solvent.
7. Apply sealant to the check valve threads. Reinstall the check valve. Do not overtighten.
8. Replace the outlet tube and tighten top and bottom nuts. Do not overtighten.
9. Replace the pressure release tube and tighten nuts. Do not overtighten.

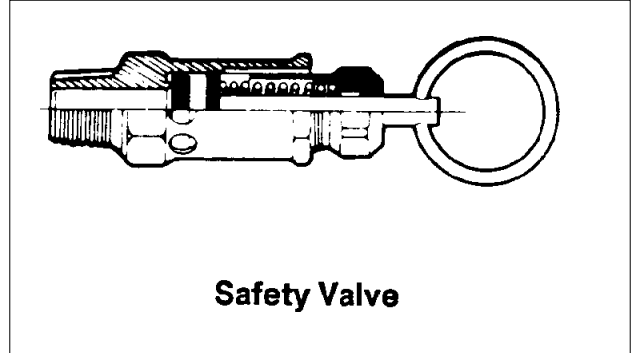

## Safety Valve - Inspection and Replacement

### **⚠ WARNING**

IF THE SAFETY VALVE DOES NOT WORK PROPERLY, OVER-PRESSURIZATION MAY OCCUR, CAUSING AIR TANK RUPTURE OR EXPLOSION. OCCASIONALLY PULL THE RING ON THE SAFETY VALVE TO MAKE SURE THAT THE SAFETY VALVE OPERATES FREELY. IF THE VALVE IS STUCK OR DOES NOT OPERATE SMOOTHLY, IT MUST BE REPLACED WITH A VALVE HAVING THE SAME PRESSURE RATING.

### **⚠ WARNING**

SERIOUS INJURY OR DAMAGE MAY OCCUR IF PARTS OF THE BODY OR LOOSE ITEMS GET CAUGHT IN MOVING PARTS. NEVER OPERATE THE OUTFIT WITH THE BELT GUARD REMOVED. THE BELT GUARD SHOULD BE REMOVED ONLY WHEN THE COMPRESSOR POWER IS DISCONNECTED.

The safety valve is set at the factory to a pressure approximately 15 pounds higher than the rated pressure of the outfit. If the pressure switch malfunctions and does not shut off the motor automatically at maximum tank pressure, the safety valve will protect the air tank against excessive air pressure by popping off at its preset pressure.

# SERVICE INSTRUCTIONS

## Adjusting Belt Tension

Adjust belt tension as described below.

For compressors with a motor slide mount, adjust belt tension as follows:

1. Slide motor away from compressor until desired tension is obtained.

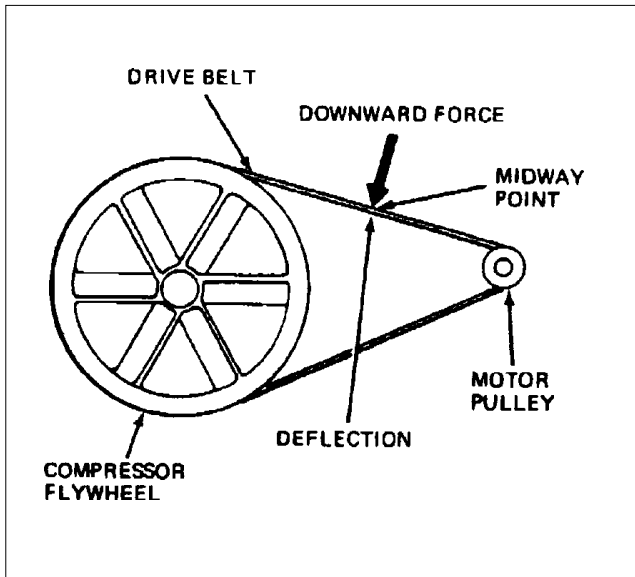

On two stage compressors, the belt should deflect 1/2" at midway between the pulley and the flywheel.

2. Tighten two outside cap screws enough to hold the motor in place for checking pulley and flywheel alignment.
3. Tighten all four mounting screws to 20-25 ft.-lbs.

## Motor Pulley and Flywheel Alignment

1. Remove outer beltguard - To remove, loosen and remove beltguard screws located at top of beltguard. Insert a flat bladed screwdriver and pry beltguard apart.
2. Place a straight edge along the outside face of the compressor flywheel to check alignment of V-belt grooves. (See figure below for proper alignment.)
3. If the belt grooves aren't aligned, continue with step 4 of this procedure. If the belt grooves are aligned, continue with step 6 of this procedure.
4. Loosen pulley set screw and adjust pulley until it is in proper alignment.
5. Tighten pulley set screw to 145-165 in.-lbs.
6. Reinstall belt guard.

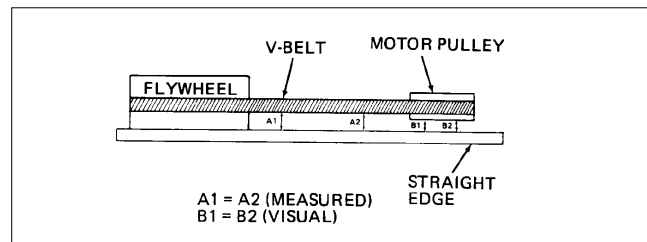



# ***SERVICE INSTRUCTIONS***

## **Additional Service**

Disassembly or service of the air compressor beyond what is covered in this manual is not recommended.

If additional service is required, contact your nearest Authorized Warranty Service Center.

## ***STORAGE OF COMPRESSOR OUTFIT***

1. Review the Maintenance section on the preceding pages and perform scheduled maintenance as necessary. Drain the water from the air tank.
2. Turn compressor off and disconnect or lock out power source.
3. Remove any air tool or accessory.
4. Protect the electrical cord and/or air hose from damage (such as being stepped on or run over).
5. Store the compressor in a clean and dry location.

# TROUBLESHOOTING GUIDE

## ⚠ WARNING

**PERFORMING REPAIRS MAY EXPOSE VOLTAGE SOURCES, MOVING PARTS OR COMPRESSED AIR SOURCES. PERSONAL INJURY MAY OCCUR. PRIOR TO ATTEMPTING ANY REPAIRS, DISCONNECT POWER SOURCE FROM THE COMPRESSOR AND BLEED OFF ALL TANK AIR PRESSURE.**

PROBLEM	CAUSE	CORRECTION
Excessive tank pressure - safety valve pops off (units with ON-AUTO switch)	Pressure switch does not shut off motor when compressor reaches "cut-out" pressure.  Pressure switch "cut-out" too high.  Incorrect wiring connections.	Move the pressure switch lever to the "OFF" position. If the outfit doesn't shut off, and the electrical contacts are welded together, replace the pressure switch.  Contact Service Center to check and adjust, or replace switch.  See "Wiring of Compressor Units"
Excessive tank pressure - safety valve pops off (units with out ON-AUTO switch).	Pressure switch does not shut off motor when compressor reaches "cut-out pressure".  Incorrect wiring connections.	Pressure switch must be replaced.  See "Wiring of Compressor Units"
Air leaks at fittings or hose.	Tube fittings are not tight enough.	Tighten fittings where air can be heard escaping. Check fittings with soapy water solution. <b>DO NOT OVER-TIGHTEN.</b>
Air leaks at or inside check valve.	Defective or dirty check valve.	A defective check valve results in a constant air leak at the pressure release valve when there is pressure in the tank and the compressor is shut off. Remove and clean or replace check valve. <b>DO NOT OVER-TIGHTEN.</b>
Air leaks at pressure switch release valve during running.	Defective pressure switch release valve.	Remove and replace the release valve.
Continuous air relieving from pressure switch release valve after shut off.	Defective check valve.	See "Air Leak at Check Valve."
Air leaks in air tank or at air tank welds.  Defective air tank.		Air tank must be replaced.  <b>⚠ WARNING</b> <b>DO NOT DRILL INTO, WELD, OR OTHERWISE MODIFY AIR TANK. IT WILL WEAKEN. THE TANK CAN RUPTURE OR EXPLODE.</b>
Air leak from safety valves.	Possible defect in safety valves.	Operate safety valves manually by pulling on ring. If a valve still leaks, it should be replaced.
Squealing sound.	Loose belt.  There is no oil in the compressor.	Adjust belt tension. (See Belt Replacement.)  Add oil. (See Oil-Checking and Changing)

# TROUBLESHOOTING GUIDE

PROBLEM	CAUSE	CORRECTION
Motor will not run.	<p>Motor overload protection switch has tripped.</p> <p>Tank pressure exceeds pressure switch "cut-in pressure".</p> <p>Check valve stuck open.</p> <p>Loose electrical connections.</p> <p>Possible defective capacitor.</p> <p>Paint spray on internal motor parts.</p> <p>Possible defective motor.</p> <p>Fuse blown, circuit breaker tripped.</p> <p>Pressure release valve on pressure switch has not unloaded head pressure.</p>	<p>Let motor cool off and reset switch by pressing the red button located on the end of the motor. If the overload still trips, check for defective capacitor.</p> <p>Motor will start automatically when tank pressure drops below "cut-in pressure" of pressure switch.</p> <p>Remove and clean or replace. DO NOT OVERTIGHTEN.</p> <p>Check wiring connection inside pressure switch and motor terminal box area.</p> <p>Return to Service Center for inspection or replacement if necessary.</p> <p>Have checked at Service Center. Do not operate the compressor in the spray area. See Flammable Vapor Warning.</p> <p>Have checked by a local Service Center.</p> <ol style="list-style-type: none"> <li>1. Check fuse box for blown fuse and replace if necessary. Reset circuit breaker. Do not use a fuse or circuit breaker with higher rating than that specified for your particular branch circuit.</li> <li>2. Check for proper fuse; only dual element time delay fuses are acceptable. Use a Fusetron Type "T" time delay fuse.</li> <li>3. Check for low voltage conditions.</li> <li>4. Remove check valve and clean or replace if it is stuck open or closed.</li> <li>5. Disconnect the other electrical appliances from circuit or operate the compressor on its own branch circuit.</li> </ol> <p>On an on/auto pressure switch equipped with a pressure relief valve, bleed the line by pushing the pressure switch to the OFF position. If valve does not open, bend the lever until it does. If valve still fails to bleed, replace the valve assembly.</p>
Excessive belt wear.	<p>Loose belt/tight belt.</p> <p>Loose pulley.</p>	<p>Adjust belt tension. (See Belt Replacement.)</p> <p>Check for worn keyway or pulley bore. Also check for bent motor shaft. Replace parts if necessary. (Refer to the Outfit Parts Manual.)</p>
Compressor is not supplying enough air to operate accessories.	<p>Prolonged excessive use of air.</p> <p>Compressor is not large enough for air requirement.</p> <p>Restricted air intake filter.</p>	<p>Decrease amount of air usage.</p> <p>Check the accessory air requirement. If it is higher than the CFM or pressure supplied by your air compressor, you need a larger compressor.</p> <p>Clean or replace air intake filter. Do not operate the compressor in the paint spray area.</p>

# TROUBLESHOOTING GUIDE

PROBLEM	CAUSE	CORRECTION
Compressor is not supplying enough air to operate accessories. (Continued)	<p>Loose belt.</p> <p>Hole in hose.</p> <p>Check valve restricted.</p> <p>Air leaks.</p>	<p>Adjust belt tension.</p> <p>Check and replace if required.</p> <p>Remove and clean or replace.</p> <p>Tighten fittings. (See "Air Leaks" section of "Troubleshooting Guide".)</p>
Knocking noise.	<p>Defective check valve.</p> <p>Loose pulley.</p> <p>Low oil level.</p> <p>Loose flywheel.</p> <p>Loose compressor mounting screws.</p> <p>Belt too tight/too loose.</p> <p>Carbon build-up.</p>	<p>Remove and clean or replace.</p> <p>Tighten pulley set screw, 145 to 165 in.-lbs.</p> <p>Maintain prescribed oil level. Add oil.</p> <p>Tighten screw, 33 to 37 ft.-lbs.</p> <p>Check screws. Tighten as required.</p> <p>Adjust belt tension. (See Belt Replacement.)</p> <p>Remove the head and valve plate. Clean the valve plate and the top of the piston. (Be sure carbon does not fall into the cylinder.) Reassemble using new gaskets and torque screws, 30 to 39 ft.-lbs.</p>
Excessive oil consumption.	<p>Restricted air intake.</p> <p>Compressor overworked.</p> <p>Poor quality oil.</p>	<p>Replace the air intake.</p> <p>Reduce air consumption or add another air compressor to take up some of the load.</p> <p>Drain pump and replace with correct oil. Refer to Lubrication and Oil Section.</p>
Compressor overheating.	<p>The compressor is overworked.</p> <p>The check valve is restricted.</p> <p>Dirty compressor.</p> <p>High ambient temperature.</p>	<p>Reduce air consumption or add another air compressor to take up some of the load.</p> <p>Inspect the check valve. Clean if necessary.</p> <p>Clean the compressor thoroughly.</p> <p>Use remote air intake.</p>
Motor overheating.	<p>Incorrect oil, low oil.</p> <p>Compressor starting against load.</p> <p>Low voltage.</p> <p>Pressure switch set beyond factory setting.</p> <p>Belt too tight.</p> <p>Compressor valves have excessive carbon deposits build-up; restricted check valve.</p>	<p>See oil recommendation on page 14.</p> <p>Dirty or defective check valve.</p> <p>Provide correct voltage. Consult local power company or electrician.</p> <p>Do not set switch beyond maximum for which outfit was designed as noted on nameplate.</p> <p>Adjust for proper tension.</p> <p>Clean or replace compressor valves or check valve.</p>

# TROUBLESHOOTING GUIDE

PROBLEM	CAUSE	CORRECTION
<p>Motor overheating. (Continued)</p>	<p>Too many motor starts per hour.</p> <p>Improper wiring gauge. Incorrect voltage.</p>	<p>Consult Service Center.</p> <p>Check electrical hookup and installation data or consult electrician.</p>
<p><b>NOTE</b></p> <p>Current style electric motors run relatively hot under normal operating conditions, with reasonable compressor loading. This condition is normal and no adjustment is necessary.</p> <p>Under normal operating conditions, the motor amperage draw will not exceed the nameplate amperage rating, plus the service factor, as it appears on the electric motor. If a condition of sustained high amperage exists, refer to service checks above and/or consult electrician. If cause cannot be isolated by an electrician, consult with Service Center for additional assistance.</p>		
<p>Water in pump crankcase; oil appears milky in color.</p>	<p>Humid operating conditions.</p> <p>Unit not reaching proper operating temperature because the compressor runs infrequently and is oversized for the air requirement.</p>	<p>Relocate compressor outfit, or change oil frequently.</p> <p>Consult Service Center.</p>
<p>Liquid water or moisture in air lines.</p>	<p>Condensation forms in air lines when the warm compressed air coming from the air tank starts to cool down as it travels through the air lines.</p>	<p>Install compressed air dryer sized for the flow and dryness level required.</p>

# COMPRESSOR DIAGRAM

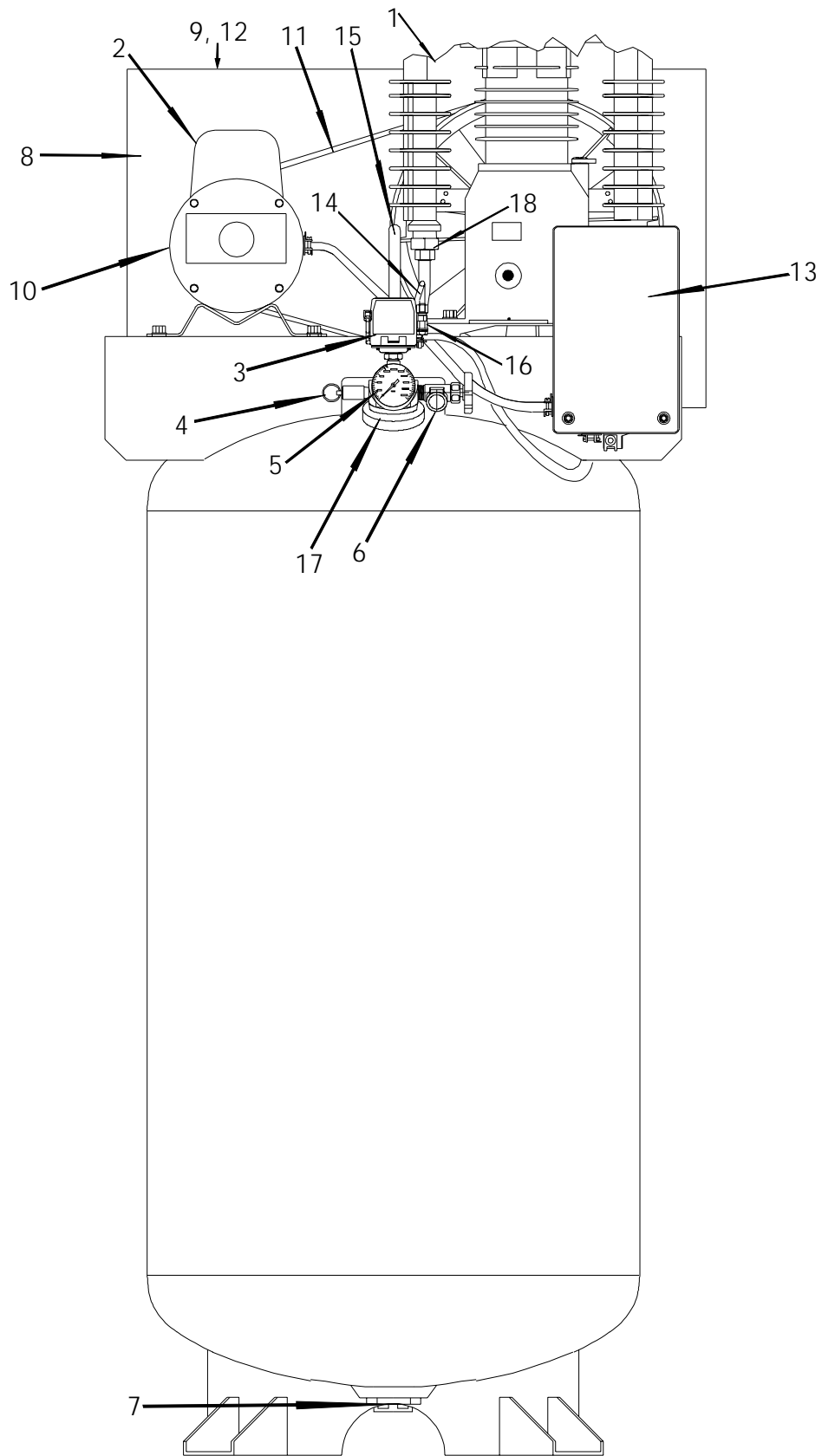

# COMPRESSOR PARTS LIST

<b>Key No.</b>	<b>Part Number</b>	<b>Description</b>
1	BAL-T39	PUMP ASSEMBLY
2	MO-9071	MOTOR
3	DAC-278-1	PRESSURE SWITCH
4	TIA-4200	SAFETY VALVE
5	GA-360	PRESSURE GAUGE
6	SSV-6	BALL VALVE
7	SS-2707	DRAIN VALVE
8	AC-0511 AC-0523	INSIDE BELTGUARD OUTSIDE BELTGUARD
9	SSF-953-ZN	BELT GUARD SCREW (2 used)
10	PU-2898	MOTOR PULLEY
11	BT-312	BELT (2 used)
12	SSF-8131	BELTGUARD NUT (2 used)
13	DAC-300-1	CONTACTOR BOX
14	DAC-304	PRESSURE RELIEF TUBE
15	AC-0517	OUTLET TUBE
16	SSP-7811	NUT/SLEEVE ASSEMBLY 1/4" (2 USED)
17	DAC-312	MANIFOLD
18	SSP-7824	NUT/SLEEVE ASSEMBLY 5/8" (2 USED)

## **Part Not Shown**

DAC-252	CHECK VALVE
AC-0467	BASE BRACKET
AC-0485	BASE BRACKET

# COMPRESSOR PUMP DIAGRAM

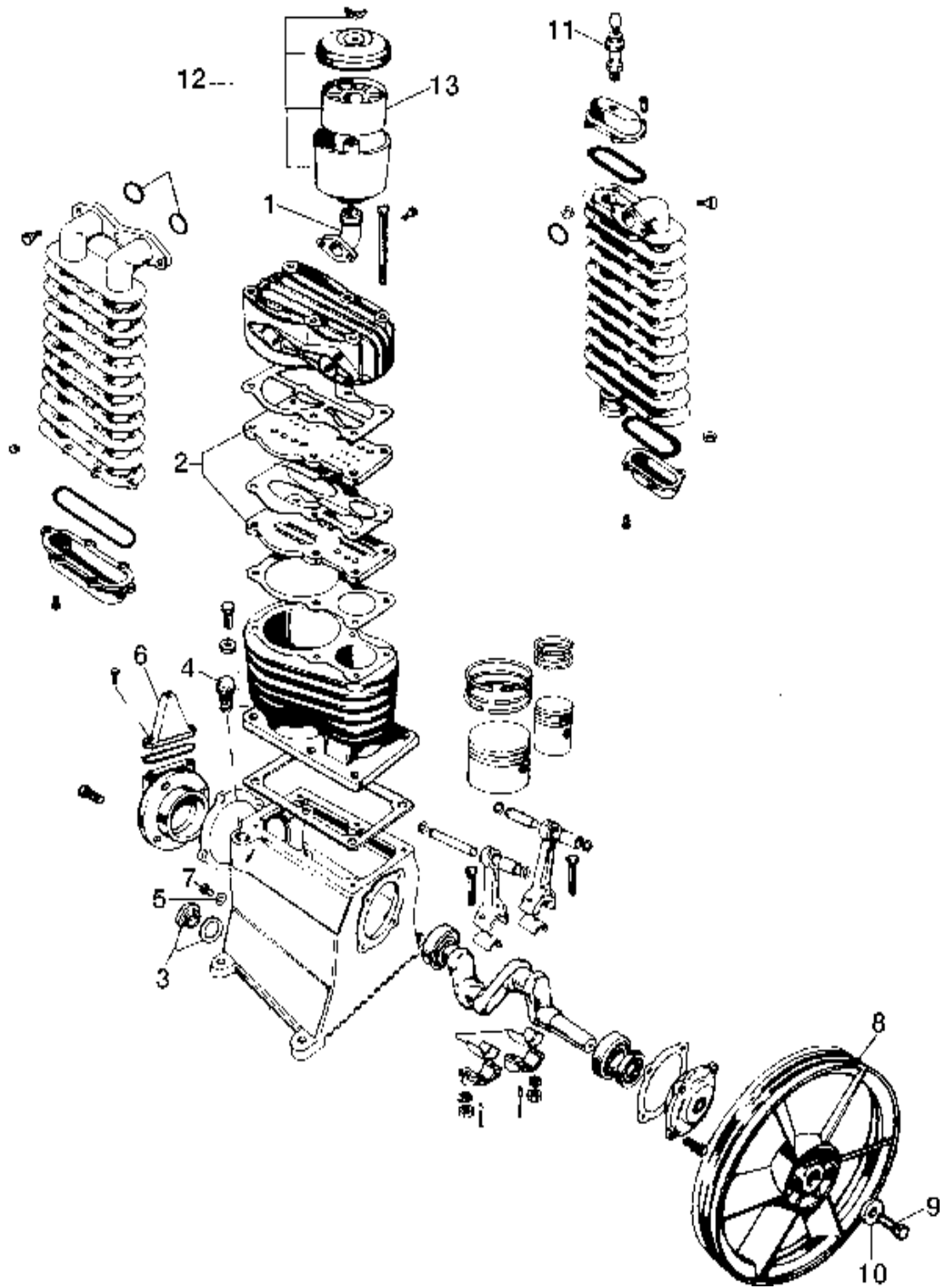



# ***PUMP PARTS LIST***

<b><u>Key No.</u></b>	<b><u>Part Number</u></b>	<b><u>Description</u></b>
1	AC-0454	AIR INLET ELBOW
2	BAL-1000345	VALVE PLATE
3	BAL-1000306	OILSIGHT GLASS
4	BAL-1000519	OIL FILL PLUG
5	BAL-1000269	OIL PLUG GASKET
6	BAL-1000112	OIL BREATHER ASSEMBLY
7	SSP-525	DRAIN PLUG
8	AC-0436	FLYWHEEL
9	BAL-1000587	FLYWHEEL BOLT
10	BAL-1000417	FLYWHEEL WASHER
11	AC-0469	SAFETY VALVE (AFTERCOOLER)
12	AC-0437	INLET FILTER ASSEMBLY
13	AC-0438	AIR FILTER ELEMENT

## **KITS AVAILABLE**

BAL-8226021	RING KIT
BAL-8226022	GASKET KIT
BAL-8226024	VALVE KIT
BAL-8226023	RUNNING GEAR KIT

# AIR FILTER INSTALLATION

## **Assembly Consists Of :**

1. Filter Assembly
2. Black Threaded Elbow
3. Elbow Bolts (2)

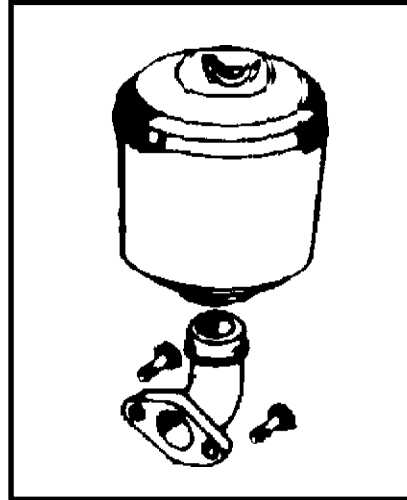

## **To Install Air Filter:**

Attach elbow to pump using bolts provided. Tighten until snug. Insert threaded end of air filter assembly into elbow and tighten until snug.

## **⚠ CAUTION**

Do not operate compressor without air filter assembly installed as this will cause damage to the compressor.

# LIMITED WARRANTY

## ONE YEAR FROM DATE OF PURCHASE

All merchandise manufactured by DeVilbiss Air Power Company is warranted to be free of defects in workmanship and material which occur during the first year from the date of purchase by the original purchaser (initial user). Products covered under this warranty include: air compressors, \*air tools, accessories, service parts, pressure washers, and generators used in consumer applications (i.e., personal residential household usage only).

Air compressors, \*air tools, accessories, service parts, pressure washers, and generators used in commercial applications (income producing) are covered by a 90 day warranty.

DeVilbiss Air Power will repair or replace, at DeVilbiss's option, products or components which have failed within the warranty period. Repair or replacement, and service calls on 60 and 80 gallon air compressors, will be handled by Authorized Warranty Service Centers and will be scheduled and serviced according to the normal work flow and business hours at the service center location, and depending on the availability of replacement parts.

All decisions of DeVilbiss Air Power Company with regard to this policy shall be final.

This warranty gives you specific legal rights, and you may also have other rights which vary from state to state.

### RESPONSIBILITY OF ORIGINAL PURCHASER (Initial User):

- Retain original cash register sales receipt as proof of purchase for warranty work.
- Use reasonable care in the operation and maintenance of the product as described in the Owners Manual(s).
- Deliver or ship the product to the nearest DeVilbiss Air Power Authorized Warranty Service Center. Freight costs, if any, must be paid by the purchaser.
- Air compressors with 60 and 80 gallon tanks only will be inspected at the site of installation. Contact the nearest Authorized Warranty Service Center, that provides on-site service calls, for service call arrangement.
- If the purchaser does not receive satisfactory results from the Authorized Warranty Service Center, the purchaser should contact DeVilbiss Air Power Company.

### THIS WARRANTY DOES NOT COVER:

- Merchandise sold as reconditioned, floor models and/or display models. Any damaged or incomplete equipment sold "as is".
- Merchandise used as "rental" equipment.
- Merchandise that has become inoperative because of ordinary wear, misuse, freeze damage, use of improper chemicals, negligence, accident, improper and/or unauthorized repair or alterations including failure to operate the product in accordance with the instructions provided in the Owners Manual (s) supplied with the product. \*Air Tools: O-Rings and driver blades are considered ordinary wear parts, therefore, they are warranted for a period of 45 days from the date of purchase.
- An air compressor that pumps air more than 50% during a one hour period is considered misuse because the air compressor is undersized for the required air demand. Maximum compressor pumping time per hour is 30 minutes.
- Merchandise sold by DeVilbiss Air Power which has been manufactured by and identified as the product of another company. The product manufacturer's warranty will apply.
- Repair and transportation costs of merchandise determined not to be defective.
- Cost associated with assembly, required oil, adjustments or other installation and start-up cost.
- ANY INCIDENTAL, INDIRECT OR CONSEQUENTIAL LOSS, DAMAGE, OR EXPENSE THAT MAY RESULT FROM ANY DEFECT, FAILURE OR MALFUNCTION OF THE PRODUCT.** Some states do not allow the exclusion or limitation of incidental or consequential damages, so the above limitation or exclusion may not apply to you.
- IMPLIED WARRANTIES, INCLUDING THOSE OF MERCHANTABILITY AND FITNESS FOR A PARTICULAR PURPOSE, ARE LIMITED TO ONE YEAR FROM THE DATE OF ORIGINAL PURCHASE.** Some states do not allow limitations on how long an implied warranty lasts, so the above limitations may not apply to you.

**DeVilbiss Air Power Company**

213 Industrial Drive • Jackson, TN 38301-9615 • Telephone: 1-800-888-2468 , Ext. 2 • FAX: 1-800-888-9036

Form: SP-100-E - 4/25/96

# OWNERS MANUAL FOR TWO-STAGE AIR COMPRESSOR

**Model No.  
LM7580V2C**

Call our **Toll Free Number 1-800-888-2468, Ext 2, then 1** to obtain the location of the nearest Authorized Service Center for ordering repair parts and for warranty repairs.

When ordering repair parts from your local Authorized Service Center, always give the following information:

- Model number of your product
- Part number and description of the item you wish to purchase

## **WARRANTY**

This product is covered by the DeVilbiss one year limited warranty. The warranty can be found in this General Manual or is available upon request.

## **Attach Sales Receipt here.**

Retain Original Sales Receipt as Proof of Purchase for Warranty Repair Work.

## Free Manuals Download Website

<http://myh66.com>

<http://usermanuals.us>

<http://www.somanuals.com>

<http://www.4manuals.cc>

<http://www.manual-lib.com>

<http://www.404manual.com>

<http://www.luxmanual.com>

<http://aubethermostatmanual.com>

Golf course search by state

<http://golfingnear.com>

Email search by domain

<http://emailbydomain.com>

Auto manuals search

<http://auto.somanuals.com>

TV manuals search

<http://tv.somanuals.com>