

OWNERS MANUAL FOR PERMANENTLY LUBRICATED AIR COMPRESSOR

**MODEL NO.
FAC100-1
(For Home Use Only)**

SPECIFICATION CHART

Model No.	FAC100-1
Horsepower	1
SCFM @ 40 psig	3.7
SCFM @ 90 psig	2.7
Bore	1 3/4"
Stroke	1 1/4"
Voltage-Single Phase	120
Minimum Branch Circuit Requirement	15 AMPS
*Fuse Type	Quick Acting
Amperage at Max Pressure	10

*A circuit breaker is preferred. Use only a fuse or circuit breaker that is the same rating as the branch circuit the air compressor is operated on. If the air compressor is connected to a circuit protected by fuses, use quick acting fuses.

SAFETY GUIDELINES - DEFINITIONS

<p>This manual contains information that is important for you to know and understand. This information relates to protecting YOUR SAFETY and PREVENTING EQUIPMENT PROBLEMS. To help you recognize this information, we use symbols to the right. Please read the manual and pay attention to these sections.</p>	<div style="border: 1px solid black; padding: 2px; display: inline-block;">⚠ DANGER</div>	<div style="border: 1px solid black; padding: 2px; display: inline-block;">⚠ CAUTION</div>
	<p>URGENT SAFETY INFORMATION - A HAZARD THAT WILL CAUSE SERIOUS INJURY OR LOSS OF LIFE.</p>	<p>Information for preventing damage to equipment.</p>
	<div style="border: 1px solid black; padding: 2px; display: inline-block;">⚠ WARNING</div>	<div style="border: 1px solid black; padding: 2px; display: inline-block;">NOTE</div>
	<p>IMPORTANT SAFETY INFORMATION - A HAZARD THAT MIGHT CAUSE SERIOUS INJURY OR LOSS OF LIFE.</p>	<p>Information that you should pay special attention to.</p>

TABLE OF CONTENTS

	Page		Page
SAFETY GUIDELINES	Cover Page	Extension Cords	6
WARRANTY STATEMENT	3	Grounding Instructions	6-7
WARNING CHART	4-5	Air Hose	7
GLOSSARY	5	OPERATING PROCEDURES	7
DUTY CYCLE	5	STORAGE	8
DESCRIPTION OF OPERATION	6	AIR COMPRESSOR DIAGRAM AND PARTS LIST	9
INSTALLATION AND BREAK-IN PROCEDURES	6-7	TROUBLESHOOTING GUIDE	10
Location of Air Compressor	6	HOW TO ORDER REPAIR PARTS	Back Cover

LIMITED WARRANTY

ONE YEAR FROM DATE OF PURCHASE

All merchandise manufactured by DeVilbiss Air Power Company is warranted to be free of defects in workmanship and material which occur during the first year from the date of purchase by the original purchaser (initial user). Products covered under this warranty include: air compressors, *air tools, accessories, service parts, pressure washers, and generators used in consumer applications (i.e., personal residential household usage only).

Air compressors, *air tools, accessories, service parts, pressure washers, and generators used in commercial applications (income producing) are covered by a 90 day warranty.

DeVilbiss Air Power will repair or replace, at DeVilbiss's option, products or components which have failed within the warranty period. Repair or replacement, and service calls on 60 and 80 gallon air compressors, will be handled by Authorized Warranty Service Centers and will be scheduled and serviced according to the normal work flow and business hours at the service center location, and depending on the availability of replacement parts.

All decisions of DeVilbiss Air Power Company with regard to this policy shall be final.

This warranty gives you specific legal rights, and you may also have other rights which vary from state to state.

RESPONSIBILITY OF ORIGINAL PURCHASER (Initial User):

- Retain original cash register sales receipt as proof of purchase for warranty work.
- Use reasonable care in the operation and maintenance of the product as described in the Owners Manual(s).
- Deliver or ship the product to the nearest DeVilbiss Air Power Authorized Warranty Service Center. Freight costs, if any, must be paid by the purchaser.
- Air compressors with 60 and 80 gallon tanks only will be inspected at the site of installation. Contact the nearest Authorized Warranty Service Center, that provides on-site service calls, for service call arrangement.
- If the purchaser does not receive satisfactory results from the Authorized Warranty Service Center, the purchaser should contact DeVilbiss Air Power Company.

THIS WARRANTY DOES NOT COVER:

- Merchandise sold as reconditioned, floor models and/or display models. Any damaged or incomplete equipment sold "as is".
- Merchandise used as "rental" equipment.
- Merchandise that has become inoperative because of ordinary wear, misuse, freeze damage, use of improper chemicals, negligence, accident, improper and/or unauthorized repair or alterations including failure to operate the product in accordance with the instructions provided in the Owners Manual (s) supplied with the product. *Air Tools: O-Rings and driver blades are considered ordinary wear parts, therefore, they are warranted for a period of 45 days from the date of purchase.
- An air compressor that pumps air more than 50% during a one hour period is considered misuse because the air compressor is undersized for the required air demand. Maximum compressor pumping time per hour is 30 minutes.
- Merchandise sold by DeVilbiss Air Power which has been manufactured by and identified as the product of another company. The product manufacturer's warranty will apply.
- Repair and transportation costs of merchandise determined not to be defective.
- Cost associated with assembly, required oil, adjustments or other installation and start-up cost.
- ANY INCIDENTAL, INDIRECT OR CONSEQUENTIAL LOSS, DAMAGE, OR EXPENSE THAT MAY RESULT FROM ANY DEFECT, FAILURE OR MALFUNCTION OF THE PRODUCT.** Some states do not allow the exclusion or limitation of incidental or consequential damages, so the above limitation or exclusion may not apply to you.
- IMPLIED WARRANTIES, INCLUDING THOSE OF MERCHANTABILITY AND FITNESS FOR A PARTICULAR PURPOSE, ARE LIMITED TO ONE YEAR FROM THE DATE OF ORIGINAL PURCHASE.** Some states do not allow limitations on how long an implied warranty lasts, so the above limitations may not apply to you.

DeVilbiss Air Power Company

213 Industrial Drive • Jackson, TN 38301-9615 • Telephone: 1-800-888-2468, Ext. 2 • FAX: 1-800-888-9036

Form: SP-100-E - 4/25/96

IMPORTANT SAFETY INSTRUCTIONS





• SAVE THESE INSTRUCTIONS •





⚠ WARNING



IMPROPER OPERATION OR MAINTENANCE OF THIS PRODUCT COULD RESULT IN SERIOUS INJURY AND PROPERTY DAMAGE. READ AND UNDERSTAND ALL WARNINGS AND OPERATING INSTRUCTIONS BEFORE USING THIS EQUIPMENT.

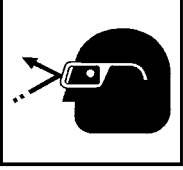

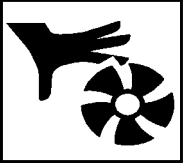
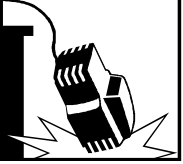
HAZARD	WHAT CAN HAPPEN	HOW TO PREVENT IT
<p>RISK OF BURSTING</p> 	<p>ATTACHMENTS & ACCESSORIES</p> <p><u>EXCEEDING THE PRESSURE RATING OF AIR TOOLS, SPRAY GUNS, AIR OPERATED ACCESSORIES, TIRES AND OTHER INFLATABLES CAN CAUSE THEM TO EXPLODE OR FLY APART, AND COULD RESULT IN SERIOUS INJURY.</u></p> <p>USE OF <u>UNAUTHORIZED REPLACEMENT AIR HOSE COULD PRODUCE EXCESSIVE SYSTEM PRESSURE AND CAUSE DAMAGES TO THE COMPRESSOR AND HOSE FAILURE WHICH COULD RESULT IN SERIOUS INJURY.</u></p>	<p>FOLLOW THE EQUIPMENT MANUFACTURERS RECOMMENDATION AND NEVER EXCEED THE MAXIMUM ALLOWABLE PRESSURE RATING OF ATTACHMENTS. NEVER USE COMPRESSOR TO INFLATE SMALL LOW-PRESSURE OBJECTS SUCH AS CHILDREN'S TOYS, FOOTBALLS, BASKETBALLS. ETC.</p> <p>HOSE IS PERMANENTLY ATTACHED TO THE COMPRESSOR AND SHOULD ONLY BE REPLACED BY AUTHORIZED SERVICE CENTER PERSONNEL USING CERTIFIED REPLACEMENT PARTS.</p>
<p>RISK OF EXPLOSION OR FIRE</p>  	<p><u>IT IS NORMAL FOR ELECTRICAL CONTACTS WITHIN THE MOTOR AND PRESSURE SWITCH TO SPARK.</u></p> <p><u>IF ELECTRICAL SPARKS FROM COMPRESSOR COME INTO CONTACT WITH FLAMMABLE VAPORS, THEY MAY IGNITE, CAUSING FIRE OR EXPLOSION.</u></p> <p><u>RESTRICTING ANY OF THE COMPRESSOR VENTILATION OPENINGS WILL CAUSE SERIOUS OVERHEATING AND COULD CAUSE FIRE.</u></p> <p><u>UNATTENDED OPERATION OF THIS PRODUCT COULD RESULT IN PERSONAL INJURY OR PROPERTY DAMAGE.</u></p>	<p>ALWAYS OPERATE THE COMPRESSOR IN A WELL VENTILATED AREA FREE OF COMBUSTIBLE MATERIALS, GASOLINE OR SOLVENT VAPORS.</p> <p>IF SPRAYING FLAMMABLE MATERIALS, LOCATE COMPRESSOR AT LEAST 20 FEET AWAY FROM SPRAY AREA. AN ADDITIONAL LENGTH OF HOSE MAY BE REQUIRED.</p> <p>STORE FLAMMABLE MATERIALS IN A SECURE LOCATION AWAY FROM COMPRESSOR.</p> <p>NEVER PLACE OBJECTS AGAINST OR ON TOP OF COMPRESSOR. OPERATE COMPRESSOR IN AN OPEN AREA AT LEAST 12 INCHES AWAY FROM ANY WALL OR OBSTRUCTION THAT WOULD RESTRICT THE FLOW OF FRESH AIR TO THE VENTILATION OPENINGS.</p> <p>ALWAYS REMAIN IN ATTENDANCE WITH THE PRODUCT WHEN IT IS OPERATING. UNPLUG COMPRESSOR WHENEVER IS NOT BEING USED.</p>
<p>RISK OF ELECTRICAL SHOCK</p> 	<p><u>YOUR AIR COMPRESSOR IS POWERED BY ELECTRICITY. LIKE ANY OTHER ELECTRICALLY POWERED DEVICE, IF IT IS NOT USED PROPERLY IT MAY CAUSE ELECTRIC SHOCK.</u></p> <p><u>REPAIRS ATTEMPTED BY UNQUALIFIED PERSONNEL CAN RESULT IN SERIOUS INJURY OR DEATH BY ELECTROCUTION.</u></p> <p><u>ELECTRICAL GROUNDING: FAILURE TO PROVIDE ADEQUATE GROUNDING TO THIS PRODUCT COULD RESULT IN SERIOUS INJURY OR DEATH FROM ELECTROCUTION. SEE GROUNDING INSTRUCTIONS.</u></p>	<p>NEVER OPERATE THE COMPRESSOR OUTDOORS WHEN IT IS RAINING OR IN WET CONDITIONS</p> <p>ANY ELECTRICAL WIRING OR REPAIRS REQUIRE ON THIS PRODUCT SHOULD BE PERFORMED BY AUTHORIZED SERVICE CENTER PERSONNEL. IN ACCORDANCE WITH NATIONAL AND LOCAL ELECTRICAL CODES.</p> <p>MAKE CERTAIN THAT THE ELECTRICAL CIRCUIT TO WHICH THE COMPRESSOR IS CONNECTED PROVIDES PROPER ELECTRICAL GROUNDING, CORRECT VOLTAGE AND ADEQUATE FUSE PROTECTION.</p>

HAZARD	WHAT CAN HAPPEN	HOW TO PREVENT IT
<p>RISK FROM FLYING OBJECTS</p> 	<p>YOUR AIR COMPRESSOR IS POWERED BY THE COMPRESSED AIR STREAM CAN CAUSE SOFT TISSUE DAMAGE TO EXPOSED SKIN AND CAN PROPEL DIRT, CHIPS, LOOSE PARTICLES AND SMALL OBJECTS AT HIGH SPEED, RESULTING IN PROPERTY DAMAGE OR PERSONAL INJURY.</p>	<p>ALWAYS WEAR ANSI Z87.1 APPROVED SAFETY GLASSES WITH SIDE SHIELDS WHEN USING THE COMPRESSOR.</p> <p>NEVER POINT ANY NOZZLE OR SPRAYER TOWARD ANY PART OF THE BODY OR AT OTHER PEOPLE OR ANIMALS.</p>
<p>RISK TO BREATHING</p> 	<p>THE COMPRESSED AIR FROM YOUR COMPRESSOR IS NOT SAFE FOR BREATHING! THE AIR STREAM MAY CONTAIN CARBON MONOXIDE, TOXIC VAPORS OR SOLID PARTICLES.</p> <p>SPRAYED MATERIALS SUCH AS PAINT, PAINT SOLVENTS, PAINT REMOVER, INSECTICIDES, WEED KILLERS, ETC.. CONTAIN HARMFUL VAPORS AND POISONS.</p>	<p>NEVER INHALE AIR FROM THE COMPRESSOR EITHER DIRECTLY OR FROM A BREATHING DEVICE CONNECTED TO THE COMPRESSOR.</p> <p>WORK IN AN AREA WITH GOOD CROSS-VENTILATION. READ AND FOLLOW THE SAFETY INSTRUCTIONS PROVIDED ON THE LABEL OR SAFETY DATA SHEETS FOR THE MATERIAL YOU ARE SPRAYING. USE A NIOSH/MSHA APPROVED RESPIRATOR DESIGNED FOR USE WITH YOUR SPECIFIC APPLICATION.</p>
<p>RISK FROM MOVING PARTS</p>  	<p>MOVING PARTS CAN CAUSE SERIOUS INJURY OR DAMAGE IF THEY COME INTO CONTACT WITH YOU OR YOUR CLOTHING.</p> <p>ATTEMPTING TO OPERATE OR REPAIR COMPRESSOR WITH PROTECTIVE SHROUDS REMOVED CAN EXPOSE YOU TO MOVING PARTS AND ELECTRICAL SHOCK.</p> <p>A PORTABLE COMPRESSOR CAN FALL FROM A TABLE, WORKBENCH OR ROOF CAUSING DAMAGE TO THE COMPRESSOR WHICH COULD EXPOSE YOU TO HAZARDOUS MOVING OR ELECTRICAL PARTS.</p>	<p>ALWAYS TURN OFF THE COMPRESSOR, BLEED PRESSURE FROM THE AIR HOSE, AND UNPLUG FROM ELECTRICAL OUTLET BEFORE PERFORMING MAINTENANCE OR ATTACHING TOOLS AND ACCESSORIES.</p> <p>DO NOT REMOVE THE PROTECTIVE COVERS FROM THIS PRODUCT. NEVER OPERATE THE COMPRESSOR WITH GUARDS OR COVERS WHICH ARE DAMAGED OR REMOVED.</p> <p>ANY REPAIRS REQUIRED ON THIS PRODUCT SHOULD BE PERFORMED BY AUTHORIZED SERVICE CENTER PERSONNEL.</p> <p>ALWAYS OPERATE COMPRESSOR IN A STABLE SECURE POSITION TO PREVENT ACCIDENTAL MOVEMENT OF THE UNIT. NEVER OPERATE COMPRESSOR ON A ROOF OR OTHER ELEVATED POSITION. USE ADDITIONAL AIR HOSE TO REACH HIGH LOCATIONS.</p>
<p>RISK OF BURNS</p> 	<p>TOUCHING EXPOSED METAL SUCH AS THE COMPRESSOR HEAD OR OUTLET TUBE CAN RESULT IN SERIOUS BURNS.</p>	<p>NEVER TOUCH ANY EXPOSED METAL PARTS ON COMPRESSOR DURING OR IMMEDIATELY AFTER OPERATION. COMPRESSOR WILL REMAIN HOT FOR SEVERAL MINUTES AFTER OPERATION.</p>

COMPACT – 3/11/97

GLOSSARY

SCFM or CFM: Standard Cubic Feet per Minute; a unit of measurement of air delivery.

PSIG or PSI: Pounds per square inch gauge.

U.L. Listed: Products with the U.L. mark are listed by Underwriters Laboratories, Inc. (U.L.). Samples of these products have been evaluated by U.L. and meet the applicable U.L. Standards for Safety.

DUTY CYCLE

All DeVilbiss Air Power manufactured air compressors should be operated on not more than a 50% duty cycle. This means an air compressor that pumps more than 50% of one hour, is considered misuse, because the air compressor is undersized for the required air demand. Maximum compressor pumping time per hour is 30 minutes.

DESCRIPTION OF OPERATION

Air Compressor Pump: To compress air, the piston moves up and down in the cylinder. On the downstroke, air is drawn in through the air intake muffler (valves). The exhaust valve remains closed. On the upstroke of the piston, air is compressed. The intake valves close and compressed air is forced out through the exhaust valve and then through the air hose.

Adjustable Pressure Valve: The pressure valve controls the amount of pressure going from the air compressor to the accessory. The pressure adjusting valve can be used to set approximate pressure between 10 and 125 P.S.I. (125 P.S.I. is the highest pressure this compressor will deliver). It is normal for the adjustable pressure valve to release air during operation.

⚠ WARNING

ALWAYS SET THE PRESSURE VALVE AT OR BELOW THE REQUIRED PRESSURE FOR THE ACCESSORY BEING USED BEFORE STARTING YOUR COMPRESSOR. FOR INFLATION OR OTHER USES REQUIRING ACCURATE PRESSURE, USE A PRESSURE GAUGE.

INSTALLATION AND BREAK-IN PROCEDURES

Location of the Air Compressor

Your compressor comes to you completely assembled and ready for use. Operate the air compressor in a dry, clean, cool and well ventilated area. The air compressor pump and case are designed to allow for proper cooling. Clean or blow off dust or dirt that collects on the air compressor. A clean air compressor runs cooler and provides longer service. The ventilation openings on your air compressor are necessary to maintain proper operating temperature. Do not place rags or other containers on or near these openings.

Extension Cords

Use extra air hose instead of an extension cord to avoid voltage drop and power loss to the motor. Low voltage can cause damage to the motor.

If an extension cord must be used, be sure it is:

- a 3-wire extension cord that has a 3-blade grounding plug, and a 3-slot receptacle that will accept the plug on the compressor
- in good condition
- no longer than 50 feet
- 14 gauge (AWG) or larger. (Wire size increases as gauge number decreases.) 12 AWG, 10 AWG and 8 AWG may also be used. **DO NOT USE 16 OR 18 AWG.**

GROUNDING INSTRUCTIONS

⚠ WARNING

RISK OF ELECTRICAL SHOCK! In the event of a short circuit, grounding reduces the risk of shock by providing an escape wire for the electric current. This air compressor must be properly grounded.

The air compressor is equipped with a cord having a grounding wire with an appropriate grounding plug. The plug must be used with an outlet that has been installed and grounded in accordance with all local codes and ordinances. The outlet must have the same configuration as the plug. See illustration. **DO NOT USE AN ADAPTER.**

Inspect the plug and cord before each use. Do not use if there are signs of damage.

⚠ DANGER

IMPROPER GROUNDING CAN RESULT IN ELECTRICAL SHOCK.

INSTALLATION AND BREAK-IN PROCEDURES

Do not modify the plug that has been provided. If it does not fit the available outlet, the correct outlet should be installed by a qualified electrician.

If repairing or replacing cord or plug, the grounding wire must be kept separate from the current-carrying wires. Never connect the grounding wire to a flat blade plug terminal. The grounding wire has insulation with an outer surface that is green - with or without yellow stripes.

If these grounding instructions are not completely understood, or if in doubt as to whether the compressor is properly grounded, have the installation checked by a qualified electrician.

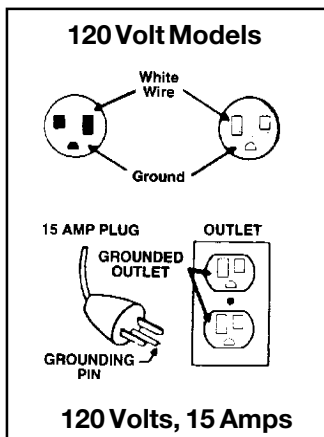

Air Hose

The air hose attached to your compressor has an integral pressure adjusting valve at the working end of the hose. Should service or replacement be required, make sure that the pressure adjusting valve is present in the air hose line. It is normal for the adjustable pressure valve to release air during operation.

⚠ WARNING

DO NOT REPLACE THE HOSE WITH STANDARD HOSE THAT IS NOT EQUIPPED WITH THE PRESSURE ADJUSTING VALVE. THE APPROPRIATE HOSE ASSEMBLY FOR YOUR COMPRESSOR IS AVAILABLE AT SEARS.

⚠ CAUTION

Do not allow hose to become kinked or pinched at any time. This is important to avoid damage to your compressor and to maintain pressure adjusting valve control.

OPERATING PROCEDURES

1. Before plugging in the air compressor, set the adjustable pressure valve to "10" PSI. Make sure the "ON/OFF" switch is in the "OFF" position.
2. Connect the air tool or accessory to the air hose. Tighten securely.
3. Plug the power cord into the grounded outlet.
4. Start the compressor by setting the "ON/OFF" switch to the "ON" position.
5. Check the manufacturer's maximum pressure rating for the air tool, accessory or vehicle tire being used. The air compressor outlet pressure must never exceed the maximum pressure rating.
6. Slowly increase the pressure setting of the adjustable pressure valve. You should be able to hear and feel air pressure being relieved by the adjustable pressure valve. If pressure is not being relieved, turn the air compressor off immediately. The pressure valve must be replaced.

⚠ WARNING

TOO MUCH AIR PRESSURE COULD CAUSE AN AIR TOOL OR VEHICLE TIRE TO RUPTURE OR EXPLODE. CAREFULLY FOLLOW STEPS 5 AND 6 EACH TIME YOU USE YOUR COMPRESSOR.

⚠ CAUTION

Compressed air from the outfit may contain water condensation. Do not spray unfiltered air at an item that could be damaged by moisture. Some air operated tools or devices may require filtered air. Read the instructions for the air tool or device.

STORAGE

When you have finished using the air compressor:

1. Set the "ON/OFF" switch to "OFF" and unplug the cord.
2. Relieve all pressure from the air compressor head and air hose by setting the adjustable pressure valve to 10 P.S.I.
3. Protect the electrical cord and air hose from damage by winding them loosely around the air compressor.
4. Store the air compressor in a clean and dry location.

AIR COMPRESSOR DIAGRAM

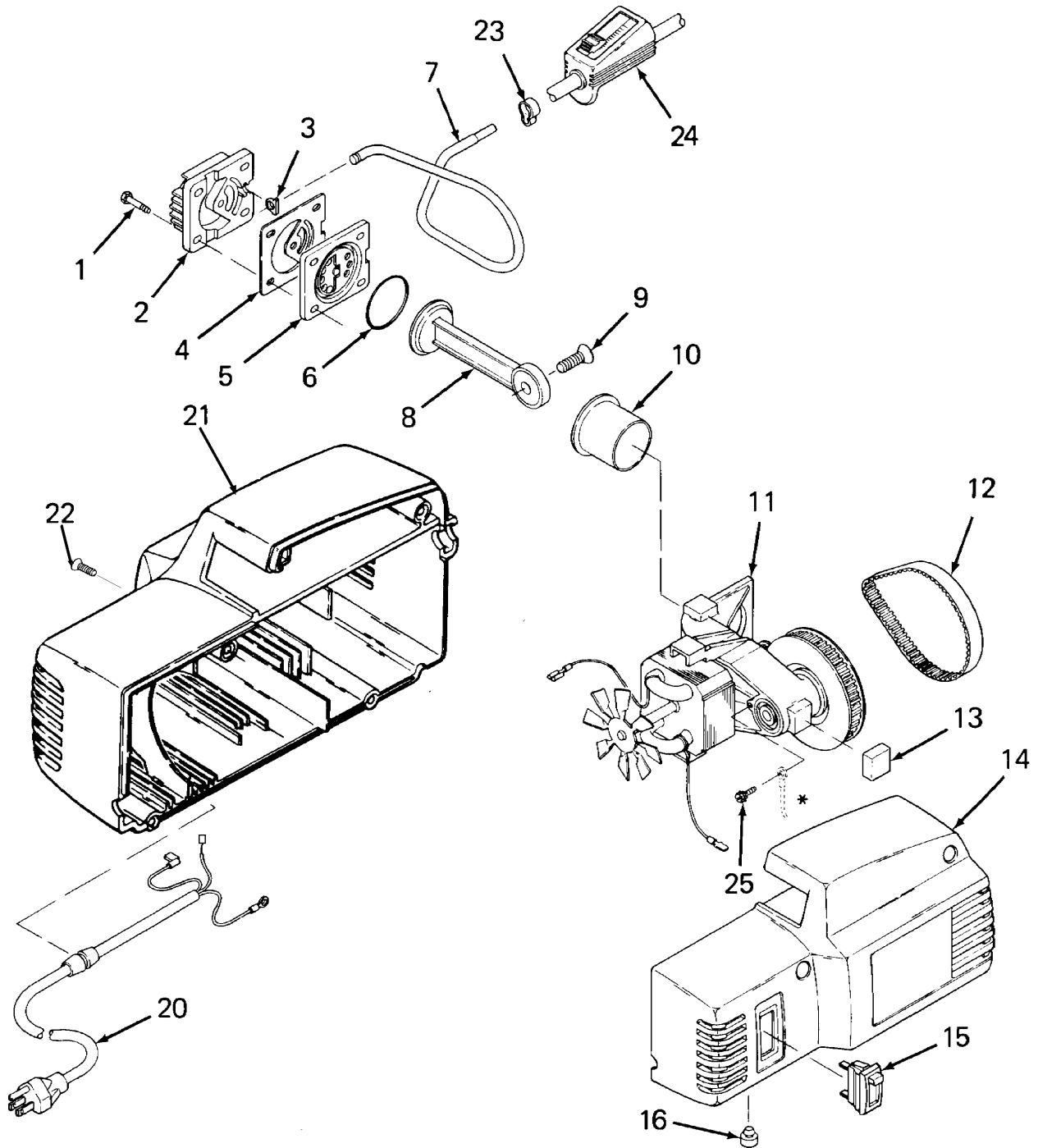

PARTS LIST

KEY NO.	PART NUMBER	DESCRIPTION
X	1	-----
	2	CAC-1196
*	3	CAC-1212
*	4	CAC-1199
	5	CAC-4323
*	6	SSG-8169
	7	CAC-1194-1
●	8	-----
X	9	-----
●	10	-----
	11	N/A
	12	CAC-1342
*	13	CAC-1213
	14	AC-0470
	15	SSS-16
*	16	CAC-1211
	20	AC-0475
	21	AC-0471
X	22	-----
	23	CAC-1206
	24	CAC-4324
X	25	-----

* KK-4930 Isolator Kit includes items 3, 4, 6, 13, 16.

x KK-4929 Fastener Kit includes items 1, 9, 22, 25.

● KK-4926 Connecting Rod Kit includes items 8, 10.

NOT ILLUSTRATED

H-2099	Adapter 1/4" x 1/4"
SSH-8	Air Chuck

TROUBLESHOOTING GUIDE

⚠ WARNING

VOLTAGE SOURCES, MOVING PARTS OR COMPRESSED AIR SOURCES ARE EXPOSED WHEN REPAIRING THE COMPRESSOR. PERSONAL INJURY CAN OCCUR. UNPLUG THE COMPRESSOR BEFORE ATTEMPTING ANY REPAIRS.

PROBLEM	CAUSE	CORRECTION
Air Leaks	Hose fitting loose.	Tighten fitting.
Compressor is not delivering enough air.	Prolonged excessive use of air. Hole in hose. Air leaks.	Decrease the amount of air usage. Your compressor is not large enough for the air requirement. Replace the hose. Tighten fittings.
Motor will not run.	Fuse blown, circuit breaker tripped. Extension cord is wrong length or gauge. Loose electrical connections. Faulty motor.	<ol style="list-style-type: none"> 1. Check fuse box for blown fuse and replace as necessary. Reset circuit breaker. Do not use a fuse or circuit breaker with higher rating than that specified for your particular branch circuit. 2. Check for proper fuse. You should be using a Quick Acting fuse. 3. Check for low voltage problem. 4. Check the extension cord. 5. Disconnect the other electrical appliances from circuit or operate the compressor on its own branch circuit. Check the extension cord. Check wiring connection inside terminal box Have checked at a local Service Center.
High discharge pressure. Cannot be adjusted lower.	Adjustable pressure valve not functioning.	<div style="text-align: center; background-color: black; color: white; padding: 5px; margin-bottom: 5px;">⚠ WARNING</div> <p>RISK OF BURSTING. DO NOT OPERATE THE COMPRESSOR IF THIS PROBLEM EXISTS. ADJUSTABLE PRESSURE VALVE MUST BE REPLACED.</p>

OWNERS MANUAL FOR PERMANENTLY LUBRICATED AIR COMPRESSOR

**MODEL NO.
FAC100-1
(For Home Use Only)**

Call our **Toll Free Number 1-800-888-2468, Ext 2, then 1**, to obtain the location of the nearest Authorized Service Center for ordering repair parts and for warranty repairs.

When ordering repair parts from your local Authorized Service Center, always give the following information:

- Model number of your product
- Part number and description of the item you wish to purchase

WARRANTY

This product is covered by the DeVilbiss one year limited warranty. The warranty can be found on page 3 or is available upon request.

Attach Sales Receipt Here.

Retain Original Sales Receipt as Proof of Purchase for Warranty Repair Work.

Free Manuals Download Website

<http://myh66.com>

<http://usermanuals.us>

<http://www.somanuals.com>

<http://www.4manuals.cc>

<http://www.manual-lib.com>

<http://www.404manual.com>

<http://www.luxmanual.com>

<http://aubethermostatmanual.com>

Golf course search by state

<http://golfingnear.com>

Email search by domain

<http://emailbydomain.com>

Auto manuals search

<http://auto.somanuals.com>

TV manuals search

<http://tv.somanuals.com>