

D0804.01

D220.19

D0801.206

D0801.06

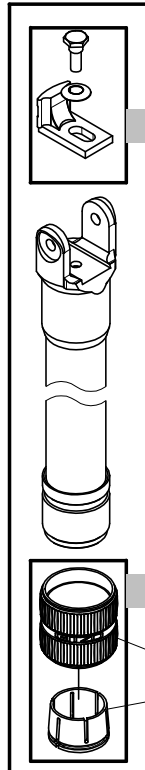

D220.40

D09901.29

D0401.28S

D0402.28

D0301.24

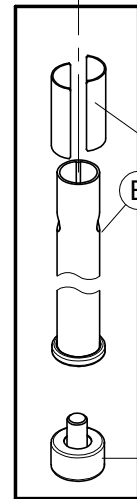

D09907.20

D0201.20
(2 pcs)

B

B

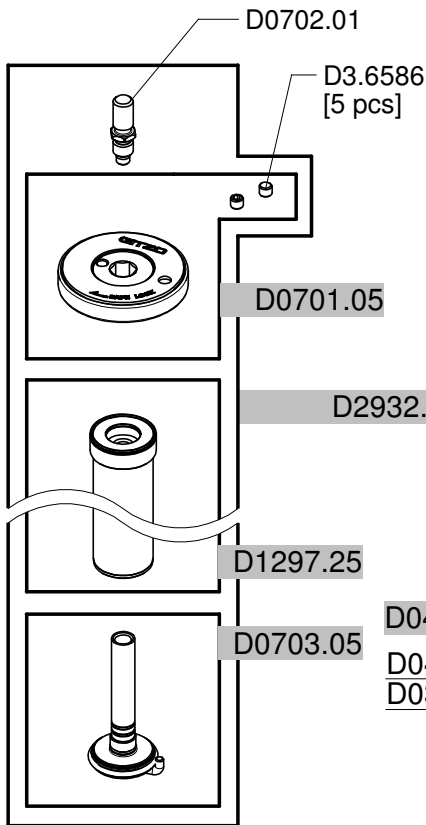

D0702.01

D3.6586
[5 pcs]

D0701.05

D2932.C

D1297.25

D0703.05

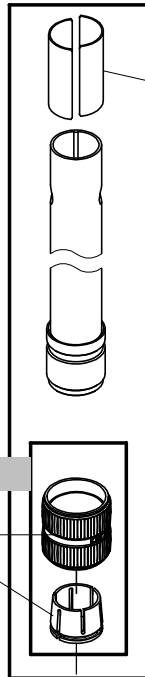

D0201.24
(2 pcs)

D09904.24

D0401.24S

D0402.24

D0301.20

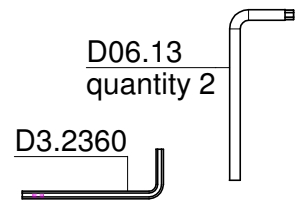

D06.13
quantity 2

D3.2360

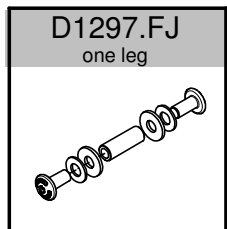

D1297.FJ
one leg

A

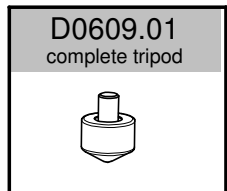

D0609.01
complete tripod

B



GT2932

For serial numbers from G0195486

Free Manuals Download Website

<http://myh66.com>

<http://usermanuals.us>

<http://www.somanuals.com>

<http://www.4manuals.cc>

<http://www.manual-lib.com>

<http://www.404manual.com>

<http://www.luxmanual.com>

<http://aubethermostatmanual.com>

Golf course search by state

<http://golfingnear.com>

Email search by domain

<http://emailbydomain.com>

Auto manuals search

<http://auto.somanuals.com>

TV manuals search

<http://tv.somanuals.com>