

Friedrich®

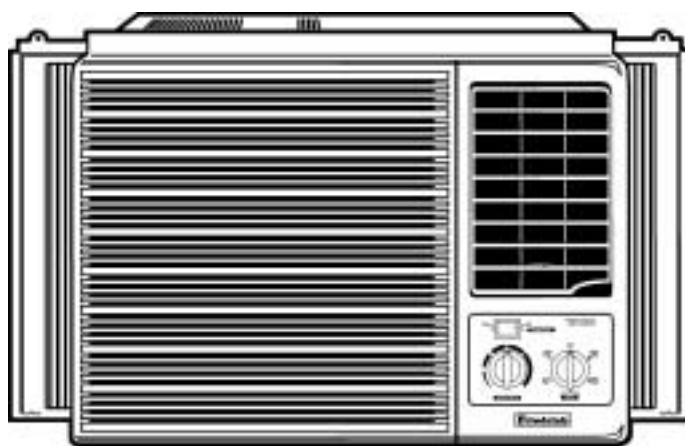

Room Air Conditioner Installation and Operating Manual



KStar®

115 Volts • **KQ08E10**

Registering Your Room Air Conditioner

Model information can be found on the name plate located on the side of the unit near the control panel. Please complete and mail the owner registration card furnished with this product or register on-line at www.friedrich.com (USA only). For your future convenience, record the model information here.

MODEL NUMBER

SERIAL NUMBER

PURCHASE DATE

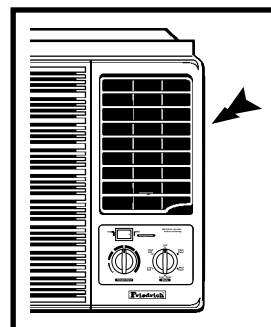

920-138-00 (01/02)

Congratulations!

You have purchased a Friedrich KStar® room air conditioner. The Friedrich KStar® is designed to provide maximum comfort and quietness.

Table of Contents

Introduction2

Safety Precautions3

How to operate your Friedrich KStar®5

Installation Instructions8

Warranty16

Introduction

Before Operating Your Unit

Make sure the wiring is adequate for your unit.

If you have fuses, they should be of the time delay type. Before you install or relocate this unit, be sure that the amperage rating of the circuit breaker or time delay fuse does not exceed the amp rating listed in figure 1.

DO NOT use an extension cord.

The cord provided will carry the proper amount of electrical power to the unit; an extension cord will not.

Make sure that the receptacle is compatible with the wall plug provided.

This insures proper grounding. If you have a two-prong receptacle you will need to replace it with a three-prong grounded receptacle that meets all national and local codes and ordinances. You must use the three-prong plug furnished with the air conditioner.

MODEL	CIRCUIT RATING OR TIME DELAY FUSE		PLUG FACE	
	AMP	VOLT	NEMA NO.	
KQ08E10	15	125	5-15P	

Figure 1

For the Best Cooling Performance and Energy Efficiency

Keep the filter clean

Make sure that your air conditioner is always in top performing condition by cleaning the filter regularly. Instructions for removing and cleaning the filter can be found on page 7.

Provide good airflow

Make sure that the airflow to and from the unit is unobstructed. Your air conditioner puts the air out at the top of the unit, and takes in air at the bottom. Airflow is critical to good operation. It is just as important on the outside of the building that the airflow around the unit exterior is not blocked.

Unit Placement

If your air conditioner can be placed in a window or a wall that is shaded by a tree or another building, the unit will operate even more efficiently. Using drapes or blinds on the sunny side of the dwelling will also add to your unit's efficiency.

Insulation

Good insulation will be a big help in maintaining desirable comfort levels. Doors should have weather stripping. Be sure to caulk around doors and windows.

Safety Precautions

To prevent injury to the user or other people and property damage, the following instructions must be followed.

■ Incorrect operation due to ignoring of instruction will cause harm or damage, the seriousness is classified by the following indications.



WARNING

This symbol indicates the possibility of death or serious injury.



CAUTION

This symbol indicates the possibility of injury or damage to properties only.

■ Meanings of symbols used in this manual are as shown below.



Be sure not to do this.



Be sure to follow the instructions.



WARNING

Plug in the power plug properly.

- Otherwise, it will cause electric shock or fire due to heat generation.



Do not operate or stop the unit by inserting or pulling out the power plug.

- It will cause electric shock or fire due to heat generation.

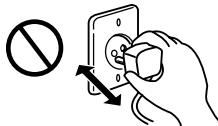

Do not damage or use an unspecified power cord.

- It will cause electric shock or fire.
- If the power cord is damaged, it must be replaced by the manufacturer or an authorized service center or a similarly qualified person in order to avoid a hazard.

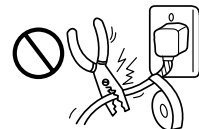

Do not modify power cord length or share the outlet with other appliances.

- It will cause electric shock or fire due to heat generation.



Do not operate with wet hand or in damp environment.

- It will cause electric shock.



Do not direct airflow at room occupants only.

- This could lead to health problems.

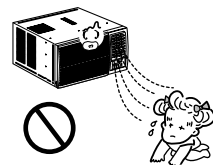

Safety Precautions



CAUTION

When the air filter is to be removed, do not touch the metal parts of the unit.

- It may cause an injury.

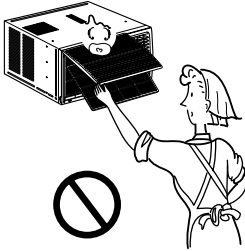

Do not clean the air conditioner with water.

- Water may enter the unit and degrade the insulation. It may cause an electric shock.

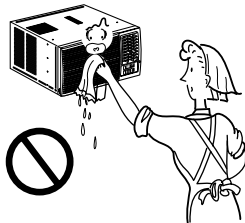

Ventilate well when used together with a stove, etc.

- An oxygen shortage may occur.

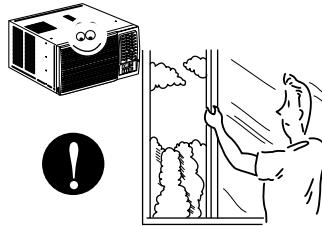

When the unit is to be cleaned, switch the unit off, and unplug it.

- Since the fan rotates at high speed during operation, it may cause an injury.

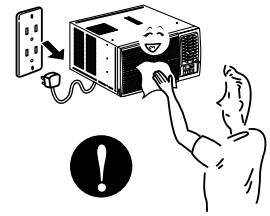

Do not put a pet or house plant where it will be exposed to direct air flow.

- This could injure the pets or plants.

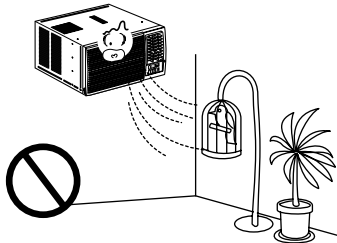

Do not use for special purposes.

- Do not use this air conditioner to preserve precision devices, food, pets, plants, and art objects. It may cause deterioration of quality, etc.

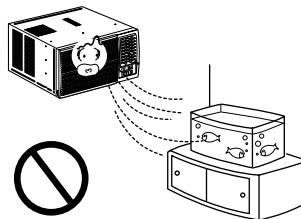

Do not operate switches with wet hands.

- It may cause an electric shock.

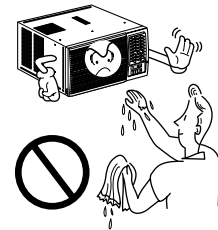

Do not apply an insecticide or flammable spray.

- It may cause a fire or deformation of the cabinet.

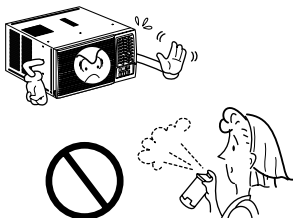

Do not put a heater, etc. where it is exposed to direct air flow.

- It may cause imperfect combustion.

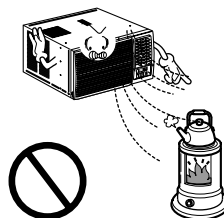

SHARP EDGES!
The edges of the case can be SHARP!

- Use caution when handling the case. Grip it firmly and do not allow it to slip while holding it.
- Use heavy gloves to handle the case if necessary.
- DO NOT allow the case to slide against your skin!

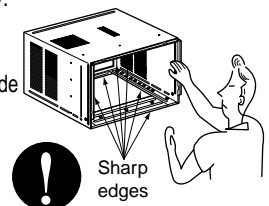

How to Operate Your KStar® Room Air Conditioner

The controls will look like the following.

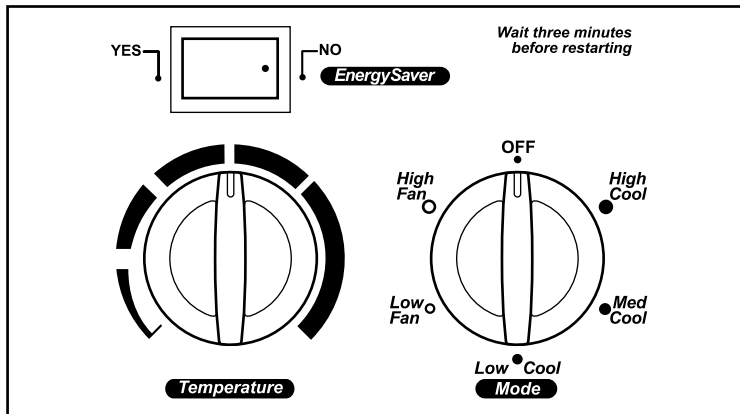

Controls

CAUTION

When the air conditioner has finished cooling the room and is turned off or set to the fan position, wait at least 3 minutes before resetting to the cooling operation again.

• FOR NORMAL COOLING

1. Turn the Mode switch to the **High, Med, or Low Cool** setting.
2. Set the Temperature control to the desired temperature point (the mid-point is a good starting position). If the room temperature is not satisfactory after a reasonable time, adjust the control to a cooler or warmer setting, as appropriate.

• FOR MAXIMUM COOLING

1. Turn the Mode switch to the **High Cool** setting.
2. Set the temperature control to the highest temperature point (all the way to the right).

• FOR QUIETER OPERATION

1. Turn the Mode switch to the **Low Cool** setting.
2. Set the Temperature control as needed.

• EnergySaver Switch

This rocker switch can be depressed to either **YES** or **NO**. In the yes position, you will get the most economical operation. Both the fan and the compressor will cycle on and off together, maintaining the selected temperature at a more constant level and reducing the humidity more efficiently. This control will only operate when the unit is in a cooling mode. In the **NO** position, the fan will run constantly as long as the unit is in the cooling mode.

How to Operate Your KStar® Room Air Conditioner

Additional controls and important information.

Ventilation

The ventilation lever must be in the CLOSE position in order to maintain the best cooling conditions. When fresh air is necessary in the room, set the ventilation lever to the OPEN position. The damper is opened and room air is drawn out.

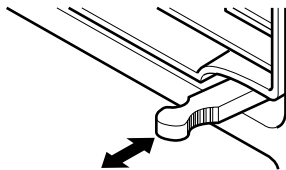

CLOSE  VENT  OPEN

NOTE: Before using the ventilation feature, make a ventilation kit. First, pull down part (A) to horizontal line with part (B).

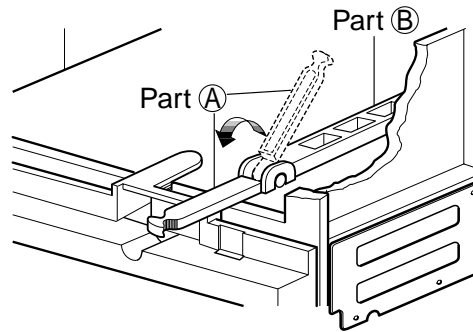

Air Direction

The direction of air can be controlled horizontally or vertically by using the horizontal louver or vertical louver.

Horizontal Air-Direction

The horizontal air direction is adjusted by moving the inside louvers to the left or right.

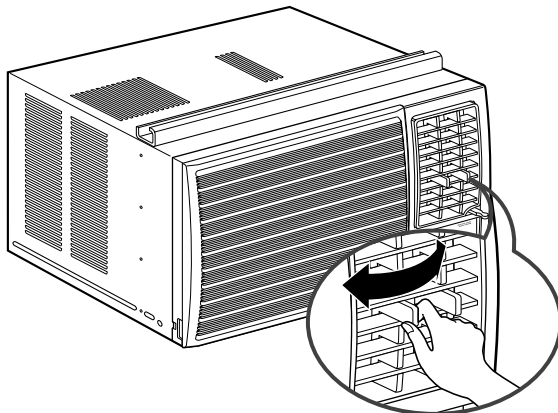

Vertical Air-Direction

The vertical (up or down) air direction is adjusted by applying pressure to the bank of the horizontal louvers.

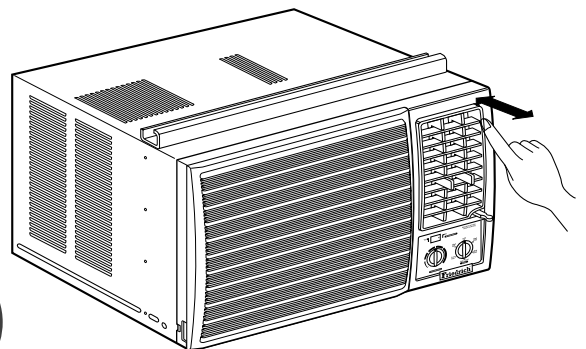

How to Operate Your KStar® Room Air Conditioner

► Care and Maintenance

Grille and Case

Turn the air conditioner off and remove the plug from the wall outlet before cleaning.

To clean, use water and a mild detergent. Do not use bleach or abrasives.

Outdoor Coils

The coils on the outdoor side of the air conditioner should be checked regularly. If they are clogged with dirt or soot they may be professionally steam cleaned, a service available through a dealer.

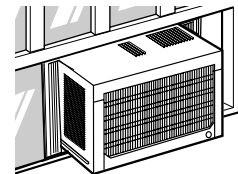

Air Filter

The air filter behind the front grille should be checked and cleaned at least once every 2 weeks or more often if necessary.

The grille is designed to clean the filter both upward and downward.

• To Remove the Filter

1. Remove the front cover by gripping the top outside edges and pulling toward you.
You will notice that the grille will only open to about a 56° angle. Do not force the grille open too far.
2. Find the two clips that hold the grille in place.
Gently lift the filter out.

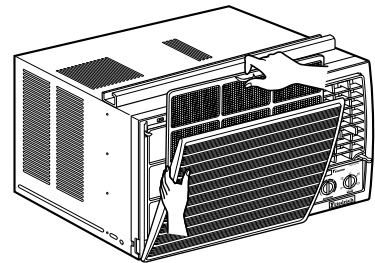

• To Clean the Filter

1. Clean with warm (104°F or 40°C) water. Be sure to shake all water off before replacing the filter.
2. Carefully position the filter, bottom first, and snap back into place.

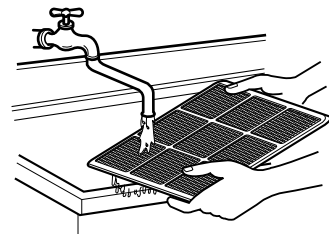

CAUTION: DO NOT operate the air conditioner without a filter because dirt and lint will clog it and reduce performance.

Drainage

In humid weather, excess water may cause the BASE PAN to overflow. To drain the water, remove the DRAIN CAP and secure the DRAIN PIPE to the rear hole of the BASE PAN.

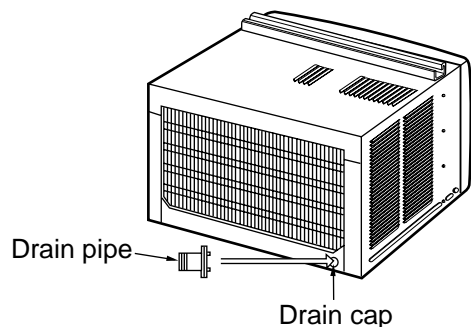

Installation Instructions

Read these instructions completely and carefully.

Before You Begin

NOTE TO INSTALLER: Leave these instructions with the air conditioner after installation is completed.

NOTE TO CONSUMER: Keep this Installation and Operating Manual for future use.

Important notes:

It is recommended that proper attire be worn during installation.

For personal safety, this air conditioner must be properly grounded.

It is important to have the wall outlet and circuit checked by a qualified electrician if there is any doubt as to whether a proper ground exists.

CAUTION:

Do not under any circumstances, cut or remove the third (ground) prong from the power cord.

Do not change the plug on the power cord of this air conditioner.

Aluminum house wiring may present special problems—consult a qualified electrician.

Electrical Data

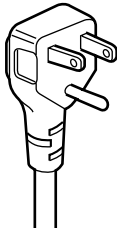
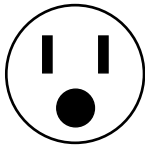
Line Cord Plug	Use Wall Receptacle	Power Supply
 Power supply cord with 3-prong grounding plug	 Standard 125V, 3-wire grounding receptacle rated 15A, 125V AC	Use 15 AMP time delay fuse or circuit breaker.

Tools You Will Need

- Phillips-head screwdriver
- Flat-blade screwdriver
- Ruler or tape measure
- Scissors or knife
- Pencil
- Level
- Hammer

Installation Instructions

Electrical safety

1 For the user's personal safety, this appliance must be properly grounded

The power cord of this appliance is equipped with a three-prong (grounding) plug. Use this with a standard three-slot (grounding) wall power outlet to minimize the hazard of electric shock. The customer should have the wall receptacle and circuit checked by a qualified electrician to make sure the receptacle is properly grounded.

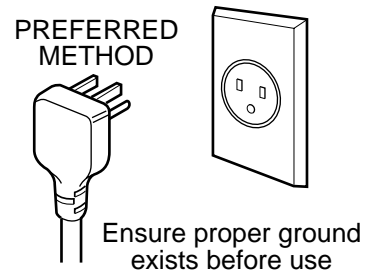

2 Do not cut or remove the third (ground) prong from the power plug

SITUATIONS WHERE THE APPLIANCE WILL BE DISCONNECTED ONLY OCCASIONALLY:

- Because of potential safety hazards, we strongly discourage the use of an adapter plug. However, if you wish to use an adapter, a TEMPORARY CONNECTION may be made. Use UL-listed adapter, available from most local hardware stores. The large slot in the adapter must be aligned with the large slot in the receptacle to assure a proper polarity connection.

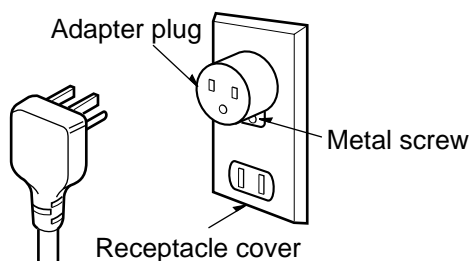

SITUATIONS WHERE THE APPLIANCE WILL BE DISCONNECTED OFTEN.

- Do not use an adapter plug in these situations. Unplugging the power cord frequently can lead to an eventual breakage of the ground terminal. The wall power outlet should be replaced by a three-slot (grounding) outlet instead.

CAUTION: Attaching the adapter ground terminal to the wall receptacle cover screw does not ground the appliance unless the cover screw is metal, and not insulated, and the wall receptacle is grounded through the house wiring.

The customer should have the circuit checked by a qualified electrician to make sure the receptacle is properly grounded.

Disconnect the power cord from the adapter, using one hand on each. Otherwise, the adapter ground terminal might break. DO NOT USE the appliance with a broken adapter plug.

3 Use of extension cords

Because of potential safety hazards, we strongly discourage the use of an extension cord.

Installation Instructions

Learning part names prior to installation will help you understanding the installation procedure.

Features

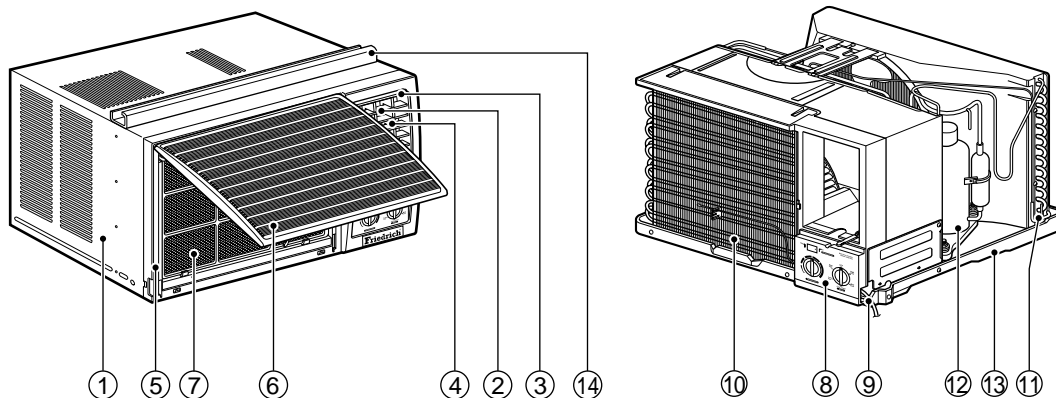

- | | |
|--|-----------------------|
| 1. CABINET | 7. AIR FILTER |
| 2. HORIZONTAL AIR DEFLECTOR
(VERTICAL LOUVER) | 8. CONTROL BOARD |
| 3. VERTICAL AIR DEFLECTOR
(HORIZONTAL LOUVER) | 9. POWER CORD |
| 4. AIR DISCHARGE | 10. EVAPORATOR |
| 5. FRONT GRILLE | 11. CONDENSER |
| 6. AIR INTAKE(INLET GRILLE) | 12. COMPRESSOR |
| | 13. BASE PAN |
| | 14. TOP MOUNTING RAIL |

Installation Hardware

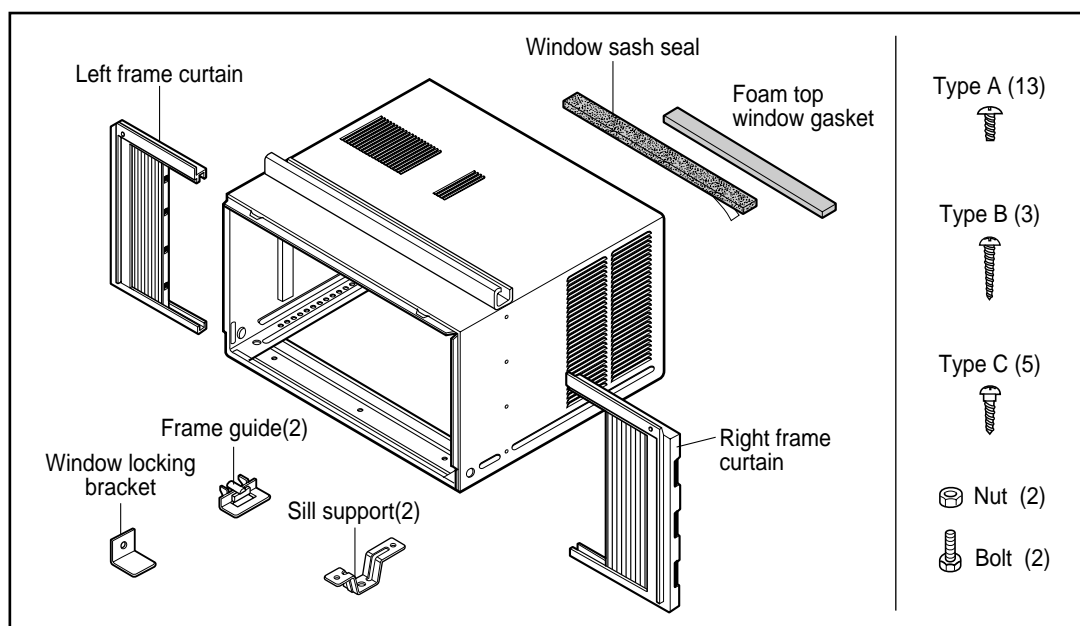

Installation Instructions

Read completely, then follow step-by step.

Select the Best Location

- Step 1. To prevent vibration and noise, make sure the unit is installed securely and firmly
- Step 2. If possible, install the unit where sunlight does not shine directly on the unit.
- Step 3. The outside of the cabinet must extend outward for at least 11" and there should be no obstacles, such as a fence or wall, within 20" from the back of the cabinet because it will prevent heat radiation of the condenser.
Restriction of outside air will greatly reduce the cooling efficiency of the air conditioner.
- Step 4. Install the cabinet with a very slight tilt (about 1/2") downward toward the outside.

CAUTION: All side louvers of the cabinet must remain exposed to the outside of the structure.

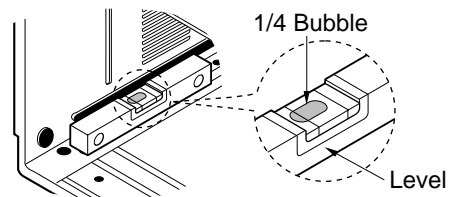
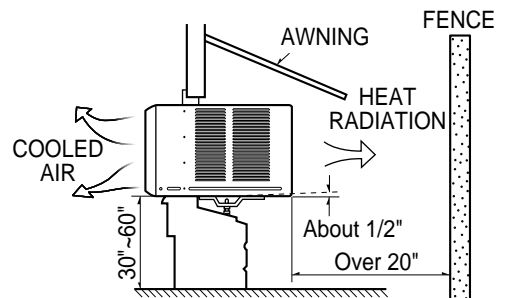

Window Requirements

- Step 1. These instructions are for a standard double hung window. You will need to modify them for other types of windows.
- Step 2. The air conditioner can be installed without the frame curtain if needed to fit in a narrow window. See the window opening dimensions to the right.
- Step 3. All supporting parts must be secured to firm wood, masonry, or metal.
- Step 4. The electric outlet must be within reach of the power cord.

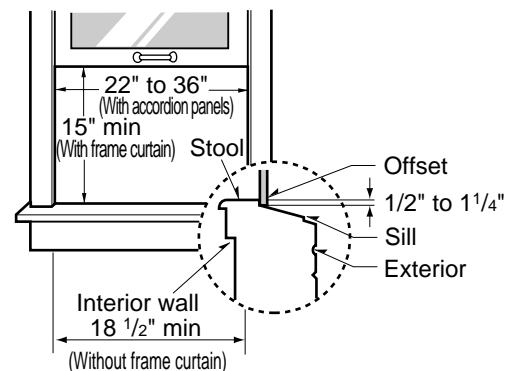

Storm Window Requirements

A storm window frame will not allow the air conditioner to tilt toward the outside and will keep it from draining properly. To adjust for this, attach a piece of wood to the stool.

WOOD PIECES-

Width: Minimum 1 1/2"(38mm)

Length: Long enough to fit inside the window frame.

Thickness: To determine the thickness, place a piece of wood on the stool to make it 1/2" higher than the top of the storm window frame. Attach securely with nails or screws provided.

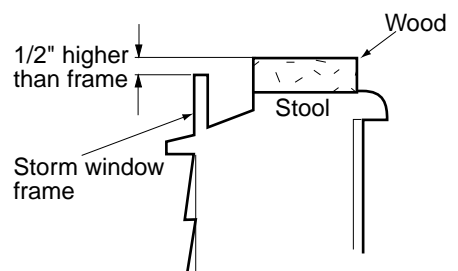

Installation Instructions

Preparing the Unit for Installation

- ✓ Remove the 2 shipping screws from the back of the case.
- ✓ Remove the 2 screws on each side of the case. Keep these for later use.
- ✓ Slide the air conditioner from the case by gripping the base pan handle and pulling forward while bracing the case.

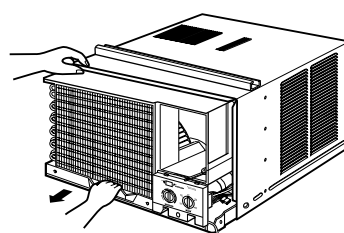
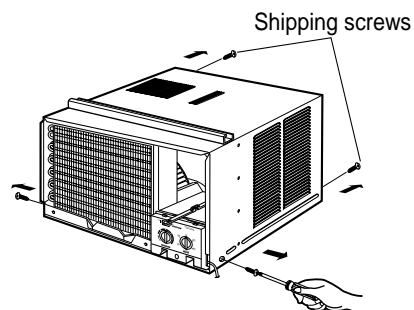

Before Installation...

- ✓ Cut the window sash seal to the proper length. Peel off the backing and attach the seal to the underside of the window sash.
- ✓ Insert the frames for the frame curtains into the top mounting rail and the frame guides. Attach the frame curtains to the side of the case using 4 type A screws

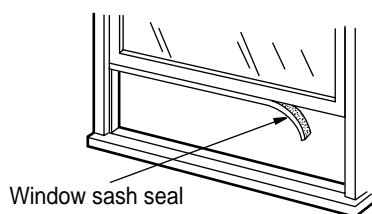

- ✓ Carefully insert the plastic frame guides into the bottom of the case on each side.

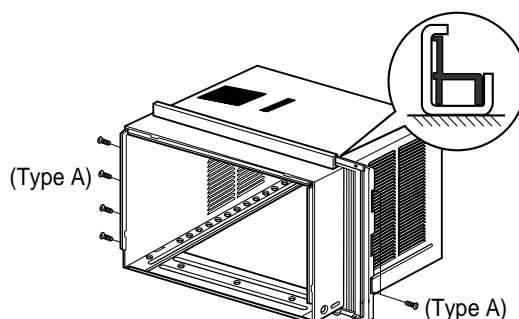
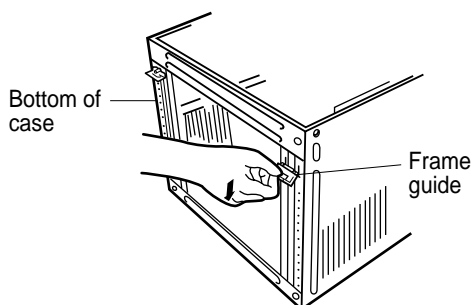

When the frame guides are set, the arrows should be pointing toward the back end of the unit.

Installation Instructions

Install the Case in the Window

- Step 1. Open the window and mark the centerline of the window stool (or desired air conditioner location).
- Step 2. Carefully place the case on the window stool and align the center mark on the bottom front with the centerline of the stool.
- Step 3. Pull the window down behind the top mounting rail.

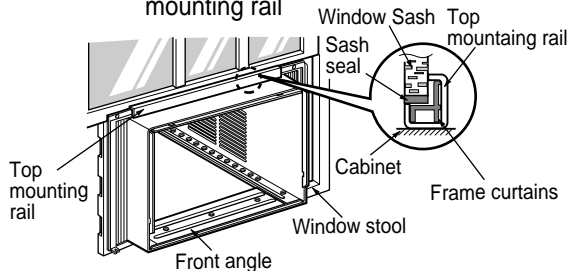

NOTE: Do not shut the window so tightly that movement of the frame curtains is restricted.

- Step 4. Loosely assemble the sill supports.

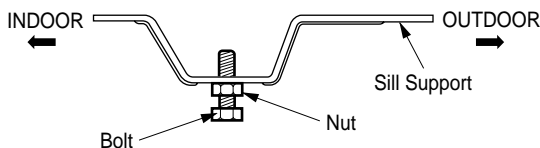

- Step 5. Select the position that will place the sill supports near the outermost point on the sill. Attach the sill supports to the case track hole in relation to the selected position using 2 type A screws in each support.

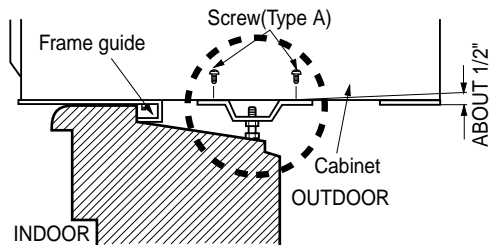

- Step 6. Adjust the bolt and the nut in each support so that the case is installed with a slight downward tilt (about 1/2").
- Step 7. Secure the case to the window stool by using 3 type B screws.

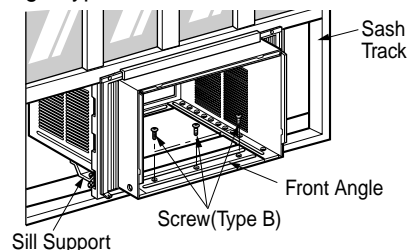

- Step 8. Pull the frame curtains to each window sash track. Attach them on each side to the window sash and the window stool using 4 type C screws.

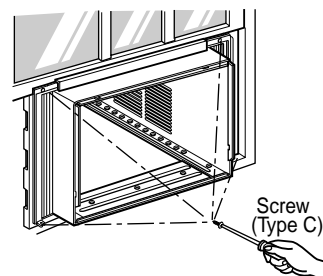

Install the Window Locking Bracket and the Foam Top Window Gasket

- Step 1. Attach the window locking bracket with type C screw.
- Step 2. Cut the foam top window gasket to the window width.
- Step 3. Stuff the foam between the glass and the window to prevent air and insects from getting into the room.

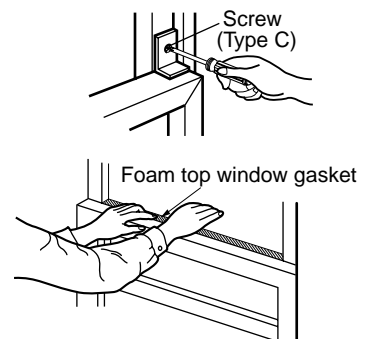

Installation Instructions

Install the Air Conditioner in the Case

Step 1. Slide the air conditioner into the case. Reinstall the 2 screws removed earlier on each side of the case.

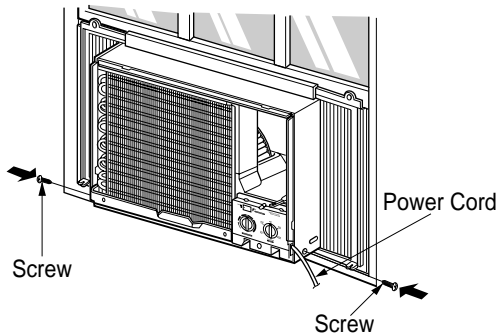

Step 3. Attach the front grille to the case by inserting the tabs on the grille into the slots on the front of the case. Push the grille in until it snaps into place.

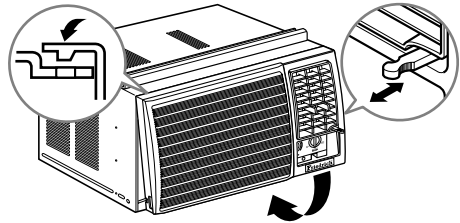

Step 2. Before installing the front grille, pull out the vent control lever located above the unit control knobs, as shown.

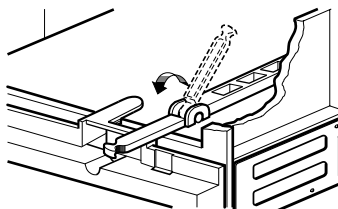

When you detach the front grille from the case, push the grille to your right side and pull it toward you.

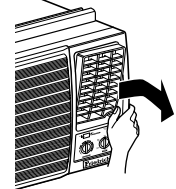

Step 4. Lift the inlet grille and secure the front grille with a Type A screw. Lower the inlet grille into place.

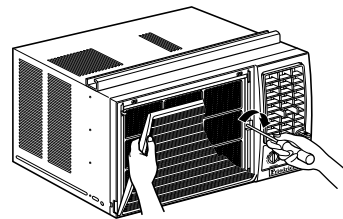

To Reverse the Grille Opening

The Friedrich KQ08E10 has a reversible grille. The grille is designed to open from both the top and the bottom.

To reverse the grille opening, you must follow the following steps;

- Step 1. Pull the entire grille of the front of the unit and locate the hinges that hold the grille in place on the inside of the grille.
- Step 2. Insert the tip of a flat screwdriver in between one of the Hinges and the ball shaped bearing of the grille.
- Step 3. Very carefully pull the bearing out of the socket of the Hinge and repeat steps 1-3 for the remaining hinge and socket.
- Step 4. Locate the top hinges on the grille.
- Step 5. Turn the grille upside down. Using flat screwdriver, create an opening on the top hinge and insert the ball shaped bearing to snap the grille in place. Repeat the same steps on the remaining hinge.

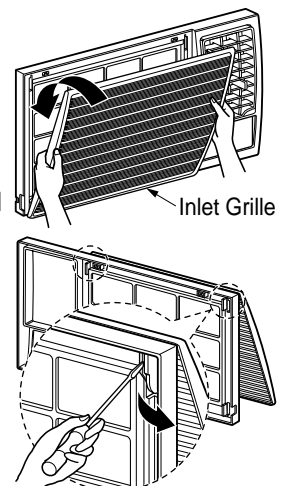

Troubleshooting Tips



Troubleshooting Tips

Save time and money! Review the chart below first and you may not need to call for service.

Normal Operation

- You may hear a pinging noise caused by water being picked up and thrown against the condenser on rainy days or when the humidity is high. This design feature helps remove moisture and improve efficiency.
- You may hear the thermostat click when the compressor cycles on and off.
- Water will collect in the base pan during high humidity or on rainy days. The water may overflow and drip from the outdoor side of the unit.
- The fan may run even when the compressor does not.
- Your air conditioner is designed to cool in warm weather when the outside temperature is above 60°F(16°C) and below 115°F(46°C).

Abnormal Operation

Problem	Possible Causes	What To Do
Air conditioner does not start	■ <i>The air conditioner is unplugged.</i>	• Make sure the air conditioner plug is pushed completely into the outlet.
	■ <i>The fuse is blown/circuit breaker is tripped.</i>	• Check the house fuse/circuit breaker box and replace the fuse or reset the breaker.
	■ <i>Power failure.</i>	• If power failure occurs, turn the mode control to OFF . When power is restored, wait 3 minutes to restart the air conditioner to prevent tripping of the compressor overload.
Air conditioner does not cool as it should	■ <i>Airflow is restricted.</i>	• Make sure there are no curtains, blinds, or furniture blocking the front of the air conditioner.
	■ <i>The THERMOSTAT may not be set high enough.</i>	• Turn the knob to a higher setting. The highest setting provides maximum cooling.
	■ <i>The air filter is dirty.</i>	• Clean the filter at least every 2 weeks. See the operating instructions section.
	■ <i>The room may have been hot.</i>	• When the air conditioner is first turned on you need to allow time for the room to cool down.
	■ <i>Cold air is escaping.</i>	• Check for open furnace floor registers and cold air returns. • Set the air conditioner's vent to the closed position.
Air conditioner freezing up	■ <i>Cooling coils have iced up.</i>	• See Air Conditioner Freezing Up below.
	■ <i>Ice blocks the air flow and stops the air conditioner from cooling the room.</i>	• Set the mode control on high fan until the ice thaws out.



ROOM AIR CONDITIONERS LIMITED WARRANTY

FIRST YEAR

ANY PART: If any Part supplied by FRIEDRICH fails because of a defect in workmanship or material within twelve months from date of original purchase, FRIEDRICH will repair the product at no charge, provided room air conditioner is reasonably accessible for service. Any additional labor cost for removing inaccessible units will be the responsibility of the owner.

SECOND THROUGH FIFTH YEAR

SEALED REFRIGERANT SYSTEM: If the sealed refrigeration system (defined for this purpose as the compressor, condenser coil, evaporator coil, reversing valve, check valve, capillary, filter drier, and all interconnecting tubing) supplied by FRIEDRICH in your Room Air Conditioner fails because of a defect in workmanship or material within Sixty months from date of purchase, FRIEDRICH will pay a labor allowance and parts necessary to repair the Sealed Refrigeration System; **PROVIDED** FRIEDRICH will not pay the cost of diagnosis of the problem, removal and transportation of the air conditioner to and from the Service Agency, and the reinstallation charges associated with repair of the Sealed Refrigeration System. All such cost will be the sole responsibility of the owner.

APPLICABILITY AND LIMITATIONS: This warranty is applicable only to units retained within the Fifty States of the U.S.A., District of Columbia, and Canada. This warranty is not applicable to:

1. Air filters or fuses.
2. Products on which the model and serial numbers have been removed.
3. Products which have defects or damage which results from improper installation, wiring, electrical current characteristics, or maintenance; or caused by accident, misuse or abuse, fire, flood, alterations and/or misapplication of the product and/or units installed in a corrosive atmosphere, default or delay in performance caused by war, government restrictions or restraints, strikes, material shortages beyond the control of FRIEDRICH, or acts of God.

OBTAINING WARRANTY PERFORMANCE: Service will be provided by the **FRIEDRICH Authorized Dealer or Service Organization** in your area. They are listed in the Yellow Pages. If assistance is required in obtaining warranty performance, write to: Room Air Conditioner Service Manager, Friedrich Air Conditioning Co., P.O. Box 1540, San Antonio, TX 78295-1540.

LIMITATIONS: THIS WARRANTY IS GIVEN IN LIEU OF ALL OTHER WARRANTIES. Anything in the warranty notwithstanding, ANY IMPLIED WARRANTIES OF FITNESS FOR PARTICULAR PURPOSE AND/OR MERCHANTABILITY SHALL BE LIMITED TO THE DURATION OF THIS EXPRESS WARRANTY. MANUFACTURER EXPRESSLY DISCLAIMS AND EXCLUDES ANY LIABILITY FOR CONSEQUENTIAL OR INCIDENTAL DAMAGE FOR BREACH OF ANY EXPRESSED OR IMPLIED WARRANTY.

NOTE: Some states do not allow limitations on how long an implied warranty lasts, or do not allow the limitation or exclusion of consequential or incidental damages, so the foregoing exclusions and limitations may not apply to you.

OTHER: This warranty gives you specific legal rights, and you may also have other rights which vary from state to state.

PROOF OF PURCHASE: Owner must provide proof of purchase in order to receive any warranty related services.

All service calls for explaining the operation of this product will be the sole responsibility of the consumer.

All warranty service must be provided by an **Authorized FRIEDRICH Service Agency**, unless authorized by FRIEDRICH prior to repairs being made.

Revised (10/00)



Post Office Box 1540 • 4200 N. Pan Am Expressway • San Antonio, Texas 78295-1540
• (210) 357-4400 • FAX (210) 357-4480

P/NO.: 3828A20196J

920-138-00 (01/02)

Free Manuals Download Website

<http://myh66.com>

<http://usermanuals.us>

<http://www.somanuals.com>

<http://www.4manuals.cc>

<http://www.manual-lib.com>

<http://www.404manual.com>

<http://www.luxmanual.com>

<http://aubethermostatmanual.com>

Golf course search by state

<http://golfingnear.com>

Email search by domain

<http://emailbydomain.com>

Auto manuals search

<http://auto.somanuals.com>

TV manuals search

<http://tv.somanuals.com>