

Frigidaire

Use & Care Manual

Household Beverage Cooler



<u>Record Serial/Model Numbers</u>	<u>2</u>
<u>Important Safety Instructions</u>	<u>2</u>
<u>First Steps</u>	<u>3</u>
<u>General Operation</u>	<u>6</u>
<u>Helpful Hints</u>	<u>7</u>
<u>Energy Saving Tips</u>	<u>8</u>
<u>Beverage Cooler Features</u>	<u>8</u>
<u>Cleaning and Maintenance</u>	<u>8</u>
<u>Warranty</u>	<u>10</u>
<u>Troubleshooting Guide</u>	<u>11</u>

SERIAL / MODEL NUMBERS

READ AND SAVE THESE INSTRUCTIONS

This Use and Care Manual provides specific operating instructions for your model. Use your beverage cooler only as instructed in this manual. These instructions are not meant to cover every possible condition and situation that may occur. Common sense and caution must be practiced when installing, operating, and maintaining any appliance.

Record Your Model and Serial Numbers

Record the model and serial numbers in the space provided below. The model and serial number plate is located on the upper left wall inside the beverage cooler.

Model Number: _____

Serial Number: _____

Purchase Date: _____

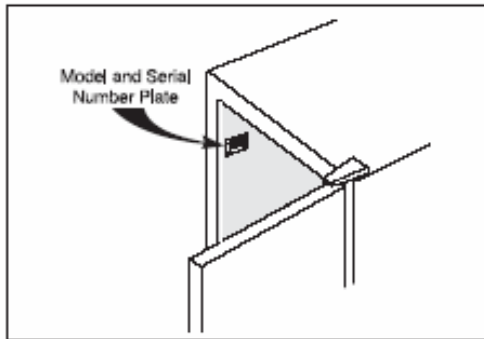

Versión en español

Si desea obtener una copia en español de este Manual del Usuario, sívase escribir a la dirección que se incluye a continuación. Solicite la P/N 297025100.

Spanish Owner's Guide
Electrolux Home Products
P.O. Box 212378
Augusta, GA 30917

IMPORTANT SAFETY INSTRUCTIONS

READ ALL INSTRUCTIONS BEFORE USING THIS BEVERAGE COOLER.

⚠ WARNING FOR YOUR SAFETY

Do not store or use gasoline, or other flammable vapors and liquids in the vicinity of this or any other appliance. Read product labels for flammability and other warnings.

⚠ WARNING CHILD SAFETY

- Destroy or safely discard carton, plastic bags, and any exterior wrapping material immediately after the beverage cooler is unpacked. Children should never use these items to play. Cartons covered with rugs, bedspreads, plastic sheets or stretch wrap may become airtight chambers, and can quickly cause suffocation.
- Remove all staples from the carton. Staples can cause severe cuts, and destroy finishes if they come in contact with other appliances or furniture.
- An empty, discarded ice box, refrigerator, beverage cooler, or freezer is a very dangerous attraction to children.
- Remove and discard any spacers used to secure the shelves during shipping. Small objects are a choke hazard to children.

Remove the door(s) of any appliance that is not in use, even if it is being discarded.

Proper Disposal of Your Refrigerator/Freezer/Beverage Cooler

⚠ WARNING Risk of child entrapment. Child entrapment and suffocation are not problems of the past. Junked or abandoned refrigerators, freezers or beverage coolers are still dangerous – even if they will sit for “just a few days.” If you are getting rid of your old freezer, refrigerator or beverage cooler, please follow the instructions below to help prevent accidents.

BEFORE YOU THROW AWAY YOUR OLD REFRIGERATOR/FREEZER/BEVERAGE COOLER:

- Remove doors.
- Leave shelves in place so children may not easily climb inside.

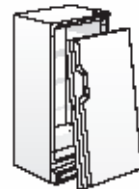

⚠ WARNING ELECTRICAL INFORMATION

These guidelines must be followed to ensure that safety mechanisms in the design of this beverage cooler will operate properly.

- Beverage Cooler must be plugged into its own 115 Volt, 60 Hz., AC only electrical outlet. The power cord of the appliance is equipped with a three-prong grounding plug for your protection against shock hazards. It must be plugged directly into a properly grounded three-prong receptacle. The receptacle must be installed in accordance with local codes and ordinances. Consult a qualified technician. **DO NOT use an extension cord or adapter plug.**

- If voltage varies by 10% or more, performance of your beverage cooler may be affected. Operating beverage cooler with insufficient power can damage the compressor.
- To prevent the beverage cooler from being turned off accidentally, do not plug unit into an outlet controlled by a wall switch or pull cord. It is recommended that a separate circuit serving only your beverage cooler be provided.
- Do not pinch, knot, or bend the cord in any manner.

⚠ WARNING OTHER PRECAUTIONS

- **DO NOT** use this appliance outside. It is designed for indoor use only.
- **NEVER** unplug the beverage cooler by pulling on the cord. Always grip the plug firmly, and pull straight out from the receptacle.
- To avoid electrical shock, unplug the beverage cooler before cleaning.

NOTE: Turning the temperature control to "OFF" turns off the compressor, but does not disconnect the power to other electrical components.

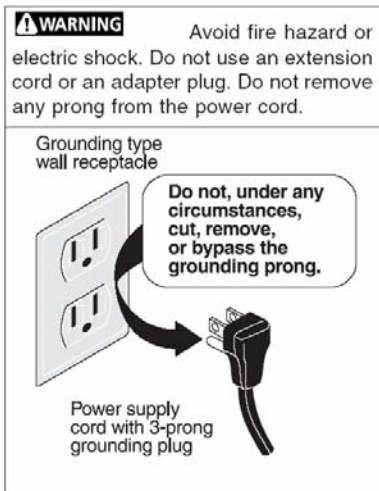

⚠ WARNING CO₂ CANISTER SAFE HANDLING

- CO₂ canisters must be handled with extreme care. They contain potentially hazardous high pressure compressed gas.
- **ALWAYS** connect CO₂ gas canisters to a pressure regulator.
- **NEVER** drop or throw the CO₂ canister.
- **NEVER** connect gas canister directly to keg.
- **ALWAYS** keep CO₂ canisters in a cool place (70° or less) and away from heat.
- In case of CO₂ leakage, ventilate and evacuate the area immediately.
- **ALWAYS** keep canister secured in an upright position.
- Check the Department of Transportation (D.O.T.) test date on the canister neck and do not use if older than 5 years.
- Return outdated canister to your gas supplier for one that is within the time window.

FIRST STEPS

This Use and Care Manual provides specific assembly, operating and maintenance instructions for your model. Use the beverage cooler only as instructed in this Use and Care Manual. **Before starting the beverage cooler, follow these important first steps.**

PARTS AND ACCESSORIES

Your beverage cooler comes with a box that contains all the parts and accessories needed for your beverage cooler. Check to make sure that you have received the box containing all of the components listed below. You will need the following tools to assemble the beverage cooler.



PHILLIPS™
SCREWDRIVER

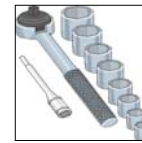

SOCKET
WRENCH



ADJUSTABLE
WRENCH



PLIERS

DRIP TRAY AND MOUNTING HARDWARE BOX

(1) Drip Tray	1 piece
(2) Drip Tray Cover	1 piece
(3) Drip Tray Bracket	1 piece
(4) CO ₂ Canister Bracket	1 piece
(5) Mounting Screws	6 pieces
(6) 4" Long Carriage Bolt	1 piece
(7) Wing Nut	1 piece
(8) Hose Routing Clips	2 pieces



(1) DRIP TRAY



(2) DRIP TRAY
COVER

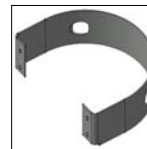

(3) DRIP TRAY
BRACKET



(4) CO₂ CANISTER
BRACKET

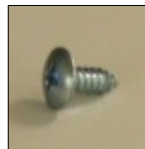

(5) MOUNTING
SCREW



(6) 4" LONG
CARRIAGE BOLT



(7) WING NUT



(8) HOSE
ROUTING CLIP

BEVERAGE DELIVERY KIT BOX

(9) Faucet and Shank Assembly	1 piece
(10) Plastic Collar	1 piece
(11) Shank Nut	1 piece
(12) Faucet Knob	1 piece
(13) Regulator	1 piece
(14) Keg Coupler	1 piece
(15) Clear Hose (Delivery Line)	1 piece
(16) Red Hose (Gas Line)	1 piece
(17) Rubber Washer (Black)	2 pieces
(18) Plastic Hose Clamp (White)	2 pieces
(19) CO ₂ Canister (Empty)	1 piece



(9) FAUCET & SHANK ASS'Y.



(10) PLASTIC COLLAR

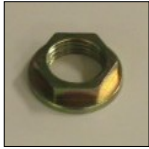

(11) SHANK NUT



(12) FAUCET KNOB



(13) REGULATOR



(14) KEG COUPLER



(15) CLEAR HOSE (DELIVERY LINE)



(16) RED HOSE (GAS LINE)



(17) RUBBER WASHER



(18) HOSE CLAMP



(19) CO₂ CANISTER

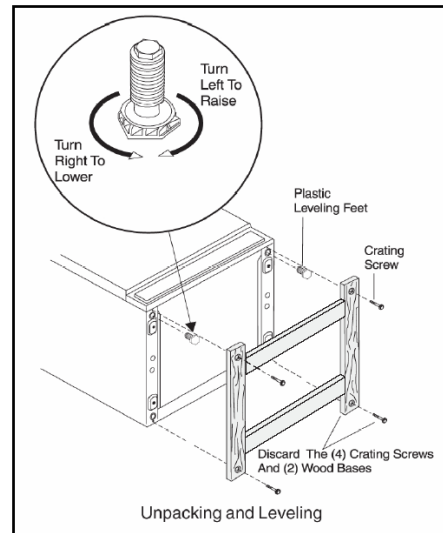

INSTALLATION – GENERAL INSTRUCTIONS

- Choose a place that is near a grounded electrical outlet. **DO NOT** use an extension cord or an adapter plug.
- For the most efficient operation, the beverage cooler should be located where surrounding temperatures will not drop below 10°F (-12°C) or exceed 110°F (43°C).
- Allow space around the unit for good air circulation. Leave a 3 inch (75 mm) space on all sides of the beverage cooler for adequate air circulation.

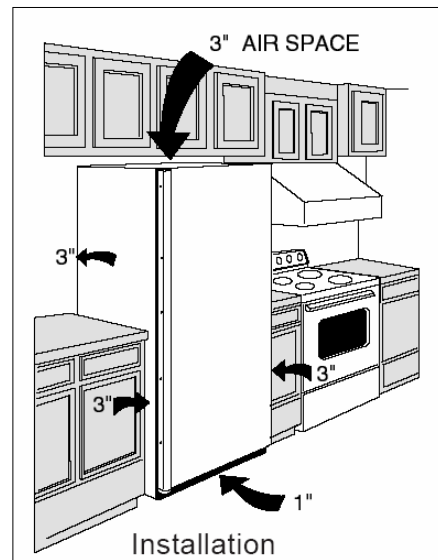

LEVELING

The beverage cooler must have all bottom corners resting firmly on a solid floor. The floor must be strong enough to support a fully loaded beverage cooler. **NOTE:** It is **Very Important** for your beverage cooler to be level in order to function properly. If the beverage cooler is not leveled during installation, the door may be misaligned and not close or seal properly, causing cooling, frost, or moisture problems.

To Level Your Beverage Cooler:

Carefully tip the unit onto its back. Remove and discard the wood skid from the bottom using a 3/8" socket wrench. After discarding crating screws and wood skid, use a carpenter's level to level the beverage cooler from front to back. Adjust the plastic leveling feet in front, 1/2 bubble higher, so that the door closes easily when left halfway open.

NOTE: The exterior walls of the beverage cooler may become quite warm as the compressor works to transfer heat from the inside. Temperatures as much as 30°F warmer than the room temperature can be expected. For this reason it is particularly important in hotter climates to allow enough space for air circulation around your beverage cooler.

CO₂ CANISTER BRACKET INSTALLATION

- Align the two bracket holes with the screw anchor holes located on the lower left side of the cabinet (the actual screw anchor holes are centered behind the taped hole).
- Secure the CO₂ canister bracket (4) to the cabinet with the two supplied mounting screws (5) using a Phillips™ screwdriver.

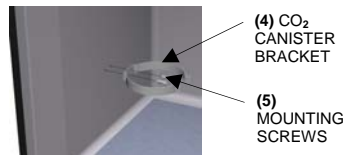

DRIP TRAY ASSEMBLY INSTALLATION

- Make sure the notched back corners are on top and attach the Drip Tray Bracket (3) to the door using four supplied mounting screws (5).
- Drop the Drip Tray (1) onto the bracket.
- Drop the Drip Tray Cover (2) onto the drip tray.

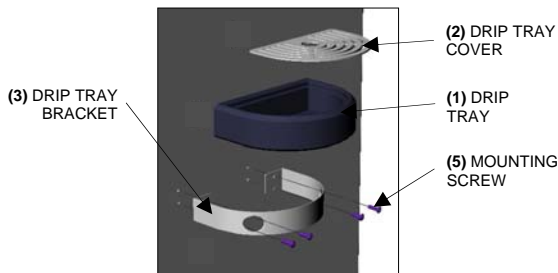

FAUCET ASSEMBLY INSTALLATION

- Attach Faucet Knob (12) to Faucet & Shank Assembly (9).
- Slip the Faucet & Shank Assembly through the black plastic Collar (10) and hole in the door.
- Thread on the large Shank Nut (11) and, using an adjustable wrench, tighten until snug. **DO NOT OVER TIGHTEN.**

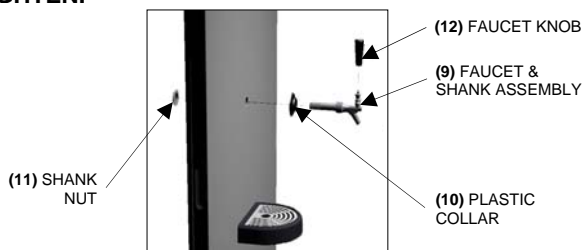

CLIP ATTACHMENT TO DOOR PANEL

- Attach the two supplied hose routing clips (8) to the door panel approximately 1~2 in (25~50mm) from the left door edge. See delivery hose arrangement on page 6.

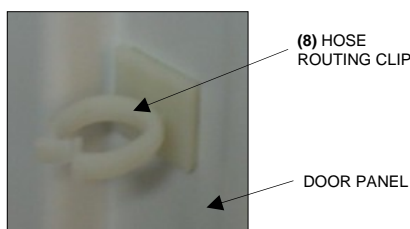

REGULATOR INSTALLATION

- Fasten the CO₂ regulator (13) to the CO₂ canister (19), tightening the nut securely. **DO NOT** over tighten. Over tightening may damage the gasket in nut of the regulator.



RED HOSE TO REGULATOR CONNECTION

- Attach one end of the red hose (16) to the hose barb of the CO₂ regulator (13). Secure the hose using one of the two hose clamps (18) provided. Use pliers to snap the hose clamp tight to assure that there is no gas leak.

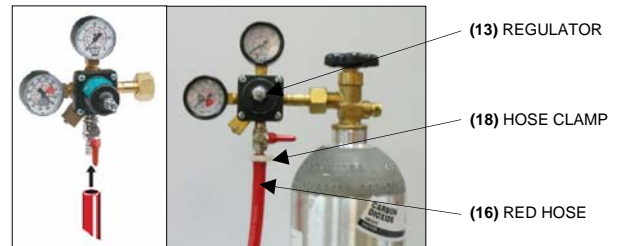

RED HOSE TO COUPLER CONNECTION

- Fasten the other end of the red hose (16) to the keg coupler (14) using the remaining hose clamp (18). Use pliers to snap the clamp tight to assure that there is no gas leak.

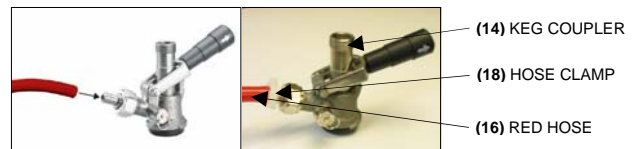

CLEAR HOSE TO COUPLER CONNECTION

- Attach the end of the clear hose (15) (beverage delivery line) with the large wing nut to keg coupler (14). Be sure to place the supplied rubber washer (17) inside the nut to prevent leakage.



CLEAR HOSE TO DOOR PANEL CONNECTION

- Place the supplied rubber washer (17) inside the hex nut on the other end of the clear hose (15) (beverage delivery line) and attach to shank protruding from the door panel

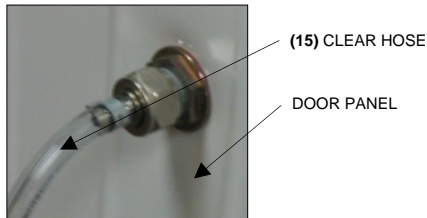

COUPLER TO KEG INSTALLATION

- Align lug locks on tap head with lug housing on top of keg and insert the tap head.
- Turn the tap head handle ¼ turn clockwise. The tap head is now secured to the keg.
- Pull the tap handle out and push down to open the port in the keg.



DELIVERY HOSE ARRANGEMENT

- Insert the clear hose (15) (delivery hose) into the hose routing clips (8) attached to the door panel. Once the hoses are properly secured, the CO₂ canister valve can now be opened.

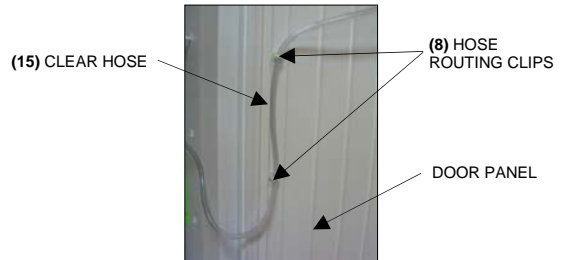

CO₂ CANISTER TO CABINET INSTALLATION

- Place the CO₂ canister (19) with the regulator (13) inside the CO₂ Canister Bracket (4) in the cabinet. It is important that the canister be kept in an upright position to operate efficiently. Fasten the canister securely in place using the 4" long carriage bolt (6) and wing nut (7) supplied with this unit.

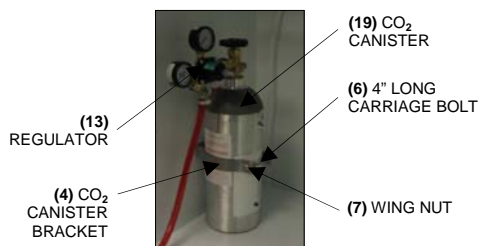

KEG TO CABINET INSTALLATION

- Place the keg next to the CO₂ canister (19) inside the cabinet as shown.

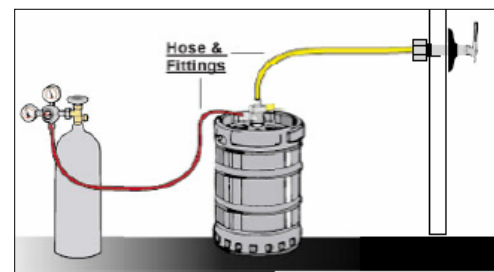
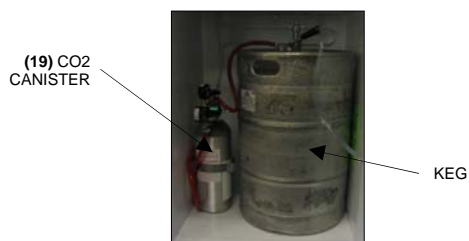

CONNECTIONS

GENERAL OPERATION

SETTING THE TEMPERATURE CONTROL

The temperature control is located on the back side of the beverage cooler. The temperature is factory preset for satisfactory storage temperature. However, the temperature control is adjustable to provide a range of temperatures for your personal satisfaction. If a colder temperature is desired, turn the control shaft of the cold control clockwise using the tip of the screwdriver as shown in the diagram below. To set the cold control to "OFF" position, turn the control shaft counter-clockwise until it stops. Allow several hours for the temperature to stabilize between adjustments.

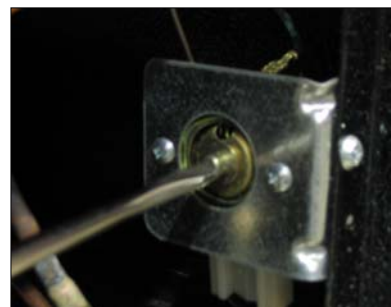

OPERATING YOUR BEVERAGE COOLER

- Make sure that the beverage cooler is plugged in properly to a 115V, 60Hz AC only electrical outlet. Refer to Electrical Information on page 2.
- Make sure that the drip tray is secured under the faucet.
- Start with a clean beverage glass that has been wetted in cold water. Place the glass at a 45° angle, one inch below the faucet. Do not let the glass touch the faucet. Open the faucet all the way.
- After the glass has reached half full, gradually bring the glass to an upright position.
- Let the remaining beverage run straight down the middle. This insures proper release of CO₂ by producing a ¾" to a 1" foam head.
- Close the faucet completely and quickly.

NOTE: It is normal to see condensation forming around the faucet. This condensation is caused by the temperature difference between the cold beverage and the inner surfaces of the faucet when beverage is being drawn through the line.

HELPFUL HINTS

PARTS OF A CO₂ REGULATOR

- (A) Low Pressure Gauge
- (B) Regulator Adjustment Screw
- (C) Adjustment Lock Nut
- (D) Shut-off Valve
- (E) CO₂ Nut (used to connect to CO₂ Canister)
- (F) High Pressure Gauge

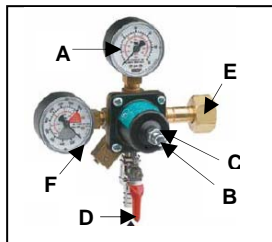

HOW TO REPLACE AN EMPTY CO₂ CANISTER

- Close the canister valve of the empty canister by turning clockwise until it stops.
- Close the regulator shut-off valve by moving it in the 3 o'clock position.
- Carefully remove regulator from the empty CO₂ canister by loosening the nut with an adjustable wrench. Check the condition of the gasket inside the nut and replace if necessary.
- Return canister to your local carbonic gas source for filling (we suggest looking in your yellow pages under "Carbonic Gas". Sources of CO₂ vary from community to community but it is often available at welding supply stores and beverage distributors).
- Remove dust cap from new canister nut, if any.

- With the canister valve still in closed position, reattach the regulator to the new canister using an adjustable wrench. Tighten nut until it feels snug but be careful not to over tighten as you will damage the gasket inside the stem nut.
- Check to make sure that the red gas line hose is still securely attached to the regulator.
- Open the canister valve all the way by turning counter clockwise until it stops. This valve seals at both the fully open and fully closed positions. Failure to completely open or close the valve could result in premature loss of CO₂ pressure.
- Open the regulator shut-off valve by moving it down to the 6 o'clock position.
- Check gauge pressure. Adjust the regulator shut-off valve as necessary until the pressure reads between 12 to 14 psi.



TIPS ON INSTALLING THE KEG TO THE CABINET

⚠ WARNING SAFE KEG HANDLING

- Installing the keg to the cabinet is a two-person team effort. **NEVER** lift a full ½ keg alone. Doing so may cause severe injury.
- With the door fully open and the help of another person, lift the keg vertically on both sides until the keg is above the bottom of the cabinet interior.
- Set the edge of the keg on top of the stainless protective plate located on the bottom of the cabinet interior. Slide the keg back until it is fully inside the cabinet.
- Care must be taken to avoid damage to the evaporator coils located on the back side of the cabinet interior.



BEER STORAGE TEMPERATURE

- Draft beer is not pasteurized, so it must be kept cold, preferably at 38°F. Temperatures above 38°F may cause the beer to become wild, turn sour and cloudy.

TYPICAL BEER SERVING EQUIVALENTS

½ Keg = 15 ½ Gallons = 1984 Fluid Ounces
½ Keg = 6 ¾ Cases of 12 ounce bottles
Overall weight of full ½ Keg is approximately 165 pounds.

¼ Keg = 7 ¾ Gallons = 992 Fluid Ounces
¼ Keg = 3 3/8 Cases of 12 ounce bottles
Overall weight of full ¼ Keg is approximately 82.5 pounds.

ENERGY SAVING TIPS

- Install the beverage cooler in the coolest part of the room, out of direct sunlight and away from heating ducts or registers. Do not place the beverage cooler next to heat-producing appliances such as a range oven or dishwasher.
- Do not overcrowd the beverage cooler or block cold air vents. Doing so causes the beverage cooler to run longer and use more energy. Shelves should not be lined with aluminum foil, wax paper or paper toweling. Liners interfere with air circulation, making the beverage cooler less efficient.
- Organize the beverage cooler to reduce door openings. Remove as many items as needed at one time and close the door as soon as possible.



BEVERAGE COOLER FEATURES

ADJUSTABLE INTERIOR SHELVES

Multi-position adjustable interior shelves can be moved to any position for larger or smaller packages. The shipping spacers that stabilize the shelves for shipping should be removed and discarded.

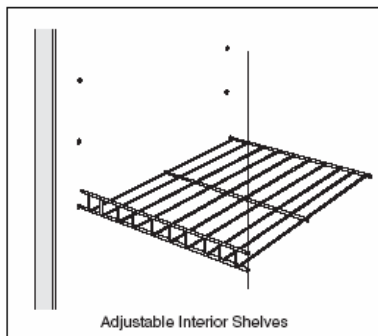

OPTIONAL CASTER KIT

If you'd like to make your beverage cooler so it can be rolled from room to room, there is an optional caster kit available from your authorized Frigidaire dealer or service center. Just ask for part number 297027300 - Caster, Rail and Hardware Kit, which includes 2 fixed casters, 2 swivel casters, 2 caster support rails and mounting hardware.

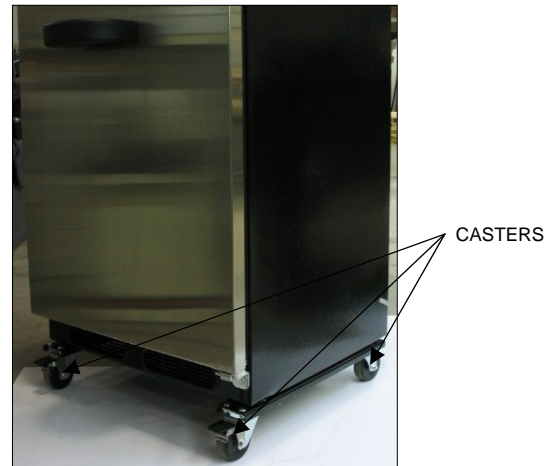

CLEANING AND MAINTENANCE

CLEANING THE INSIDE

- Wash inside surfaces of the beverage cooler with a solution of two tablespoons of baking soda in one quart (1.136 liters) warm water. Rinse and dry. Wring excess water out of the sponge or cloth when cleaning in the area of the controls, or any electrical parts.
- Wash the removable parts with the baking soda solution mentioned above, or mild detergent and warm water. Rinse and dry. **NEVER** use metallic scouring pads, brushes, abrasive cleaners, or alkaline solutions on any surface. **DO NOT** wash removable parts in the dishwasher.

CLEANING THE OUTSIDE

Wash the cabinet with warm water and mild liquid detergent. Rinse well and wipe dry with a clean soft cloth. Replace parts.

DOOR REMOVAL

If door must be removed:

- Gently lay the beverage cooler on its back, on a rug or blanket.
- Remove plastic top hinge cover.
- Remove screws from top hinge.
- Remove top hinge from cabinet.
- Remove bottom hinge screws.
- Remove door and bottom hinge from cabinet.
- To replace door, reverse the above order and securely tighten all screws to prevent hinge slippage.

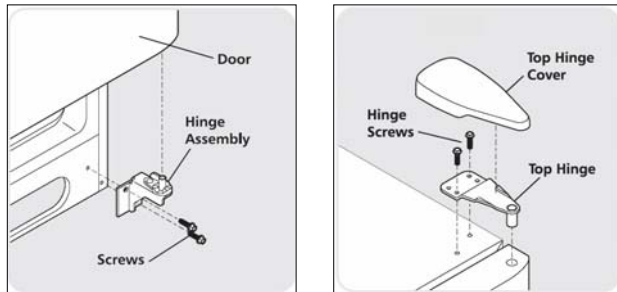

WARNING If leaving the beverage cooler door open at any time, make certain that children cannot get into the beverage cooler and become entrapped.

PROPER CLEANING OF BEVERAGE COOLER

Your beverage cooler's beverage dispensing system needs regular cleaning and sterilization in order to continue serving draft beer with its pure brewery flavor. It is recommended that the delivery lines be cleaned weekly and the entire delivery system cleaned before a new keg is attached. This is a relatively simple task. You will need the following parts to clean your unit's dispensing system. These parts are available at any draft beer dispensing equipment supplier. One such supplier is Micro Matic. They can be reached at www.micromatic.com or call them toll free at (866) 291-5756.

- (A) 1 quart Plastic Cleaning Bottle
- (B) Low Profile Hand Pump
- (C) Solid Brass Faucet Cleaning Attachment
- (D) 4 oz. Bottle of Cleaning Solution
- (E) Faucet Wrench
- (F) Faucet Cleaning Brush

- Mix one gallon of warm water with one ounce of the cleaning solution in a bucket.
- Remove the bottle cap and fill the bottle with the solution. Replace the cap. Do not discard the remaining solution.
- Before removing the beverage hose from the tap or from the coupler, make sure the remaining beverage in the delivery line is blown out. This can be done by quickly opening and closing the regulator outlet valve.

- Remove the coupler from keg by rotating it counterclockwise.
- Remove the red hose (gas line) from the coupler. Make sure the canister valve and regulator shut-off valve is shut off before removing the hose.
- Remove the faucet from the shank assembly by turning the threaded stainless steel collar clockwise using a faucet wrench.
- Disassemble the faucet parts and place in the cleaning solution bucket.
- Attach the brass attachment on the end of the cleaning hose to the faucet shank assembly by turning the stainless steel collar counterclockwise. Tighten the collar slightly.
- If the coupler has a shutoff, make sure it is in the open position.
- Place the keg coupler in the cleaning solution bucket and pump the cleaning solution through the beer line.
- Clean the faucet parts and keg coupler thoroughly using the faucet cleaning brush. Also, use the faucet cleaning brush to clean around the shank and coupling.
- Rinse all the parts with cool fresh water and reassemble the faucet.
- Detach the cleaning solution bottle from the faucet shank by turning the threaded stainless steel collar clockwise. Rinse the bottle with cool fresh water.
- Fill the bottle with fresh water and re-attach it to the faucet shank assembly. Pump the water through the beverage line (clear hose). Make sure the end of the line is in a bucket to collect rinse water.
- Disconnect the cleaner and reinstall the faucet to the shank by turning the collar counterclockwise using a faucet wrench and tightening it slightly. **DO NOT** over tighten the collar.
- Reattach the red hose (air line) to the keg coupler and open both the canister valve and regulator shut-off valve.
- Reattach the keg coupler to the keg. Refer to Coupler – Keg Installation procedures.
- Remove the drip tray and cover from the door and clean thoroughly. Refer to Cleaning and Maintenance Guide.
- Reinstall the drip tray and cover to the door. Refer to Drip Tray Assembly Installation procedures.

NOTE: Read and follow the instructions that come with the cleaning kit before cleaning your beverage cooler.

VACATION AND MOVING TIPS

- If the unit will not be used for several months, unplug the power cord, clean and dry the interior thoroughly and leave the door open slightly, blocking it open if necessary, to prevent odor and mold growth.
- When moving the unit, disconnect the power cord from the wall outlet. Thoroughly clean the interior and secure all loose items by taping them securely in place to prevent damage. In the moving vehicle, secure the unit in an upright position to prevent movement. Also, protect the outside of the unit with a blanket, or similar item.

BEVERAGE COOLER WARRANTY

Your beverage cooler is protected by this warranty

	WARRANTY PERIOD	THROUGH OUR AUTHORIZED SERVICERS, WE WILL:	THIS CONSUMER WILL BE RESPONSIBLE FOR:
FULL ONE-YEAR WARRANTY	One year from original purchase date	Pay all costs for repairing or replacing any parts of this appliance which prove to be defective in materials or workmanship.	Costs of service calls that are listed under NORMAL RESPONSIBILITIES OF THE CONSUMER.*
LIMITED 2ND-5TH YEAR WARRANTY (Cabinet Liner and Sealed System)	Second through fifth years from original purchase date	Repair or replace any parts in the cabinet liner or Sealed Refrigeration System (compressor, condenser, evaporator, drier and tubing) which prove to be defective in materials or workmanship.	Costs for pick up and delivery of the appliance required because of service. Costs for labor, parts and transportation other than with respect to the cabinet liner or Sealed Refrigeration System.
LIMITED WARRANTY (Applicable to the State of Alaska)	Five years from original purchase date	All of the provisions of the warranties above and the exclusions listed below apply.	Costs of the technician's travel to the home and any costs for pick up and delivery of the appliance required because of service.

In the U.S.A., your appliance is warranted by Electrolux Home Products, Inc. We authorize no person to change or add to any of our obligations under this warranty. Our obligations for service and parts under this warranty must be performed by us or any authorized Electrolux Home Products, Inc. servicer. In Canada, your appliance is warranted by Electrolux Canada Corp.

***NORMAL RESPONSIBILITIES OF THE CONSUMER**

This warranty applies only to products in ordinary household use, and the consumer is responsible for the items listed below:

1. Proper use of the appliance in accordance with instructions provided with the product.
2. Proper installation by an authorized servicer or in accordance with instructions provided with the appliance and in accordance with local plumbing, electrical and/or gas codes.
3. Proper connection to a grounded power supply of sufficient voltage, replacement of blown fuses, repair of loose connections or defects in house wiring.
4. Expenses for making the appliance accessible for servicing, such as removal of trim, cupboards, shelves, etc., which are not a part of the appliance when it was shipped from the factory.
5. Damages to finish after installation.
6. Replacement of light bulbs and/or fluorescent tubes (on models with these features).

EXCLUSIONS

This warranty does not cover the following:

1. CONSEQUENTIAL OR INCIDENTAL DAMAGES SUCH AS PROPERTY DAMAGE AND INCIDENTAL EXPENSES RESULTING FROM ANY BREACH OF THIS WRITTEN OR ANY IMPLIED WARRANTY.

NOTE: Some states do not allow the exclusion or limitation of incidental or consequential damages, so this limitation or exclusion may not apply to you.

2. Service calls which do not involve malfunction or defects in workmanship or material, or for appliances not in ordinary household use. The consumer shall pay for such service calls.
3. Damages caused by services performed by servicers other than Electrolux Home Products, Inc. or its authorized servicers; use of parts other than genuine Electrolux Home Products, Inc. parts; obtained from persons other than such servicers; or external causes such as abuse, misuse, inadequate power supply or acts of God.
4. Products with original serial numbers that have been removed or altered and cannot be readily determined.

IF YOU NEED SERVICE

Keep your bill of sale, delivery slip, or some other appropriate payment record. The date on the bill establishes the warranty period should service be required. If service is performed, it is in your best interest to obtain and keep all receipts. This written warranty gives you specific legal rights. You may also have other rights that vary from state to state. Service under this warranty must be obtained by contacting Electrolux Home Products, Inc. or Electrolux Canada Corp.

This warranty only applies in the 50 states of the U.S.A., Puerto Rico, and Canada. Product features or specifications as described or illustrated are subject to change without notice. All warranties are made by Electrolux Home Products, Inc. In Canada, your appliance is warranted by Electrolux Canada Corp.

01-U-FR-02 (Rev. 02/2004)

USA
800-944-9044
 Electrolux Home Products, Inc.
 P.O. Box 212378
 Augusta, GA 30917

Canada
800-265-8352
 Electrolux Canada Corp.
 6150 McLaughlin Road
 Mississauga, Ontario
 L5R 4C2

TROUBLESHOOTING GUIDE	Before calling for service, review this list. It may save you time and expense. This list includes common occurrences that are not the result of defective workmanship or materials in this appliance.	
PROBLEM	CAUSE	CORRECTION

BEVERAGE COOLER OPERATION

Beverage cooler does not run.	<ul style="list-style-type: none"> • Beverage cooler is plugged into a circuit that has a ground fault interrupt. • Temperature control is in the "OFF" position. • Beverage cooler may not be plugged in, or plug may be loose. • House fuse blown or tripped circuit breaker. • Power outage. 	<ul style="list-style-type: none"> • Use another circuit. If you are unsure about the outlet, have it checked by a certified technician. • See SETTING THE TEMPERATURE CONTROL Section. • Ensure plug is tightly pushed into outlet. • Check/replace fuse with a 15 amp time-delay fuse. Reset circuit breaker. • Check house lights. Call local Electric Company.
Beverage cooler runs too much or too long.	<ul style="list-style-type: none"> • Room or outside weather is hot. • Beverage cooler has recently been disconnected for a period of time. • Doors are opened too frequently or too long. • Beverage cooler door may be slightly open. • Temperature control is set too low. • Beverage cooler gasket is dirty, worn, cracked, or poorly fitted. 	<ul style="list-style-type: none"> • It's normal for the beverage cooler to work harder under these conditions. • It takes 4 hours for the beverage cooler to cool down completely. • Warm air entering the beverage cooler causes it to run more. Open door less often. • See "DOOR PROBLEMS" Section. • Turn the control shaft to a warmer setting. Allow several hours for temperature to stabilize. • Clean or change gasket. Leaks in the door seal will cause beverage cooler to run longer in order to maintain desired temperature.
Interior beverage cooler temperature is too cold.	<ul style="list-style-type: none"> • Temperature control is set too low. 	<ul style="list-style-type: none"> • Turn the control shaft to a warmer setting. Allow several hours for temperature to stabilize.
Interior beverage cooler temperature is too warm.	<ul style="list-style-type: none"> • Temperature control is set too warm. • Door is kept open too long or is opened too frequently. • Door may not be seating properly. • Beverage cooler has recently been disconnected for a period of time. 	<ul style="list-style-type: none"> • Turn the control shaft to a colder setting. Allow several hours for temperature to stabilize. • Warm air enters the beverage cooler every time the door is opened. Open the door less often. • See "DOOR PROBLEMS" Section. • Beverage cooler requires 4 hours to cool down completely.
Beverage cooler external surface temperature is warm.	<ul style="list-style-type: none"> • The external walls can be as much as 30°F warmer than room temperature. 	<ul style="list-style-type: none"> • This is normal while the compressor works to transfer heat from inside the beverage cooler

SOUND AND NOISE

Louder sound levels whenever beverage cooler is on.	<ul style="list-style-type: none"> • Modern beverage coolers have increased storage capacity and more stable temperatures. They require a high efficiency compressor. 	<ul style="list-style-type: none"> • This is normal. When the surrounding noise level is low, you might hear the compressor running while it cools the interior.
Longer sound levels when compressor comes on.	<ul style="list-style-type: none"> • Beverage cooler operates at higher pressures during the start of the "ON" cycle. 	<ul style="list-style-type: none"> • This is normal. Sound will level off or disappear as the beverage cooler continues to run.
Fan runs when room temperature is below 45°F.	<ul style="list-style-type: none"> • Exterior thermostat has activated the heater and fan. 	<ul style="list-style-type: none"> • This is normal.
Popping or cracking sound when compressor comes on.	<ul style="list-style-type: none"> • Metal parts undergo expansion and contraction, as in hot water pipes. 	<ul style="list-style-type: none"> • This is normal. Sound will level off or disappear as refrigerator continues to run.
Bubbling or gurgling sound, like water boiling.	<ul style="list-style-type: none"> • Refrigerant (used to cool beverage cooler) is circulating throughout the system. 	<ul style="list-style-type: none"> • This is normal.

SOUND AND NOISE (Cont.)

Vibrating or rattling noise.	<ul style="list-style-type: none"> • Beverage cooler is touching the wall. 	<ul style="list-style-type: none"> • Move beverage cooler slightly away from the wall.
Snapping sound.	<ul style="list-style-type: none"> • Cold control turning beverage cooler on and off. 	<ul style="list-style-type: none"> • This is normal.

WATER / MOISTURE / FROST INSIDE BEVERAGE COOLER

Moisture forms on inside of beverage cooler walls.	<ul style="list-style-type: none"> • Weather is hot and humid. • Door may not be seating properly. • Door is kept open too long or opened too frequently. 	<ul style="list-style-type: none"> • This is normal. • See “DOOR PROBLEMS” Section. • Open the door less often.
--	--	---

WATER / MOISTURE / FROST OUTSIDE BEVERAGE COOLER

Moisture forms on outside of beverage cooler walls.	<ul style="list-style-type: none"> • Door may not be seating properly, causing the cold air from inside the beverage cooler to meet warm moist air from outside. 	<ul style="list-style-type: none"> • See “DOOR PROBLEMS” Section.
---	---	---

ODOR IN BEVERAGE COOLER

Odors in beverage cooler.	<ul style="list-style-type: none"> • Interior needs to be cleaned. 	<ul style="list-style-type: none"> • Clean interior with sponge, warm water, and baking soda.
---------------------------	---	--

DOOR PROBLEMS

Door will not close.	<ul style="list-style-type: none"> • Beverage cooler is not level. It rocks on the floor when it is moved slightly. 	<ul style="list-style-type: none"> • This condition can force the cabinet out of square and misalign the door. Level the unit.
----------------------	--	---

COMMON DRAFT PROBLEMS

<p>WILD BEER – Beer, when drawn, is all foam, or too much foam and not enough liquid beer.</p>	<ul style="list-style-type: none"> • Beer drawn improperly. • Creeping regulator. • Applied pressure is set too high. • Hot spots in line. • Tapped into a warm keg (should be 34°F ~ 38°F). • Cooler malfunctioning. • Faucets in bad, dirty or worn condition. 	<ul style="list-style-type: none"> • Make sure faucet is opened all the way. Close quickly when done. • Replace regulator. • Readjust regulator to a lower pressure until foam subsides. When pressure is properly set, you should be able to pour 10 oz. of beer in about 5 seconds. • Make sure beer delivery line is not pinched and is fully inside the interior of the beverage cooler. • Wait until keg cools down to proper temperature. • Have beverage cooler serviced to return it to proper operating condition. • Thoroughly clean faucet with recommended cleaning kit. Replace any worn seals.
<p>FLAT BEER – Foamy head disappears quickly; beer lacks usual zestful brewery fresh flavor.</p>	<ul style="list-style-type: none"> • Dirty glasses. • Applied pressure is set too low. • CO₂ is turned off. • Beer too cold. • Loose tap or vent connections. • Sluggish regulator. 	<ul style="list-style-type: none"> • Wash glasses using soap-free detergent. • Increase pressure until beer flows at a rate of 2 oz. per second. • Do not turn off CO₂ supply line to keg until keg is empty and ready to be removed. • Increase temperature of beverage cooler (see SETTING THE TEMPERATURE CONTROL). • Check that coupler is properly installed in keg. • Replace regulator.
<p>CLOUDY BEER – When beer in glass appears hazy, not clear.</p>	<ul style="list-style-type: none"> • Frozen or nearly frozen beer. • Unrefrigerated beer for long periods of time. • Dirty glasses. • Dirty faucet. • Unrefrigerated foods placed on top of cold keg. 	<ul style="list-style-type: none"> • Return keg to place of purchase and exchange for one that has been properly refrigerated. • Exchange keg for fresh one. • Wash glasses using soap-free detergent. • Clean faucet with recommended cleaning kit. • Remove items from atop keg and place in a separate refrigerator.

3 Ways To Contact Us! ¡3 formas de contactarnos! 3 façons de nous contacter !

USA, EE.UU., É.-U.
1-800-944-9044

CANADA, CANADÁ
1-866-213-9397 (English)
1-866-294-9911 (Français)

Or, O, Ou

USA, EE.UU., É.-U.

Electrolux Home Products, Inc.
P.O. Box 212378
Augusta, GA 30917

CANADA, CANADÁ

Electrolux Canada Corp.
6150 McLaughlin Road
Mississauga, Ontario
L5R 4C2

Or,O, Ou

Visit Frigidaire's Web Site At:
Visite la página de Frigidaire en Internet:
Visitez le site Internet de Frigidaire au :

<http://www.frigidaire.com>

© 2004 Electrolux Home Products, Inc.

 **The Electrolux Group.** *The world's No.1 choice.*

The Electrolux Group is the world's largest producer of powered appliances for kitchen, cleaning and outdoor use combined. More than 55 million Electrolux Group products (such as refrigerators, cookers, washing machines, vacuum cleaners, chain saws and lawn mowers) are sold each year to a value of approx. USD 14 billion in more than 150 countries around the world.

Free Manuals Download Website

<http://myh66.com>

<http://usermanuals.us>

<http://www.somanuals.com>

<http://www.4manuals.cc>

<http://www.manual-lib.com>

<http://www.404manual.com>

<http://www.luxmanual.com>

<http://aubethermostatmanual.com>

Golf course search by state

<http://golfingnear.com>

Email search by domain

<http://emailbydomain.com>

Auto manuals search

<http://auto.somanuals.com>

TV manuals search

<http://tv.somanuals.com>