



www.gracobaby.com

Smart Seat™

ALL-IN-ONE CARSEAT

featuring



Child Restraint Owner's Manual

READ THIS MANUAL.

Do not install or use this child restraint until you read and understand the instructions in this manual.

FAILURE TO PROPERLY USE THIS CHILD RESTRAINT INCREASES THE RISK OF SERIOUS INJURY OR DEATH IN A SUDDEN STOP OR CRASH.

Before you begin

1.0 Warnings to Parents and Other Users	4
2.0 Registration Information	10
2.1 Register Your Child Restraint	10
2.2 For Recall Information	10
2.3 If You Need Help	11
3.0 Useful Information	11
3.1 Certification	11
3.2 Child Restraint Useful Life	11
3.3 Second Hand Child Restraint	11
4.0 Assembly	12
4.1 Attaching LATCH Storage Compartment	12
4.2 Attaching Cupholder	12
5.0 Features	14
5.1 Child Restraint	14
5.2 Base	16

6.0 Height and Weight Limitations	18
6.1 Rear-Facing with base	19
6.2 Forward-Facing with base	20
6.3 Booster WITHOUT base	21
7.0 Choosing an Appropriate Vehicle Seat Location	22
7.1 Vehicle Seat Location Requirements	22
7.2 Vehicle Seat Belt Requirements	23
7.3 SAFE Vehicle Seat Belt Systems	23
7.4 For Built-in Harness Only	24
7.5 WITH or WITHOUT Built-in Harness	24
7.6 UNSAFE Vehicle Belt Systems	25
8.0 LATCH	27
8.1 What is LATCH ?	27
8.2 LATCH System	29

Installation

9.0	Installing Base Using Vehicle Seat Belt	30
10.0	Installing Base Using LATCH	32
11.0	REAR-FACING INSTALLATION	34
12.0	FORWARD-FACING INSTALLATION	36
13.0	Tether Use	38
14.0	Tether and LATCH Storage	39
14.1	Tether Storage	39
14.2	LATCH Storage	39
15.0	Harness System	40
15.1	Harness Strap	40
15.2	Chest Clip	40
15.3	Buckle	42
15.4	Crotch Strap	43
16.0	Accessories	44
16.1	Body Support (on certain models)	44
16.2	Harness Covers & Crotch Strap Cover (on certain models)	45

17.0	Using Recline	46
18.0	Securing Child in Child Restraint	48
18.1	Placing Child in Child Restraint	48
18.2	Check Harness System	50
18.3	Adjusting Head Support/Harness Straps	51
19.0	Booster Installation	52
19.1	Storing Harness	52
19.2	Using Child Restraint in Booster Mode	54
19.3	Securing Child in Booster Seat and Vehicle	56
19.4	Adjusting Head Support in Booster Mode	58
20.0	Additional Information	59
20.1	Adjusting Armrest	59
20.2	Removing Seat Cover	60
20.3	Airplane Use	61
20.4	Care and Maintenance	61-62
21.0	Replacement Parts, Warranty, and Owner's Manual Storage	64

1.0 Warnings to Parents and Other Users

NEVER PLACE THIS CHILD RESTRAINT IN A VEHICLE SEATING LOCATION THAT HAS A FRONT AIR BAG. If an air bag inflates, it can hit the child and child restraint with great force and cause serious injury or death to your child. Check vehicle owner's manual for information about side air bags and child restraint installation.



- ***No child restraint can guarantee protection from injury in every situation. However, proper use of this child restraint reduces the risk of serious injury or death to your child.***
- **FAILURE TO PROPERLY USE THIS CHILD RESTRAINT** increases the risk of serious injury or death in a sharp turn, sudden stop or crash. Your child's safety depends on you installing and using this child restraint correctly. Failure to follow these instructions and child restraint labels can result in child striking the vehicle's interior during a sudden stop or crash.
- **EVEN IF USING THIS CHILD RESTRAINT** seems easy to figure out on your own, it is very important to **READ THE OWNER'S MANUAL** and the vehicle owner's manual.
 - Your child's safety depends on:
 1. **CHOOSING THE CORRECT MODE OF USE** for the child restraint depending on your child's size. Infants less than 20 lbs. must use this child restraint rear-facing.
 2. **SELECTING A SUITABLE LOCATION** for the child restraint in your vehicle. Some seating positions, such as those equipped with air bags, may not be safe locations for this child restraint.
 3. **PROPERLY ROUTING THE VEHICLE SEAT BELT OR LATCH.**

4. **PROPERLY SECURING THE CHILD RESTRAINT IN THE VEHICLE** using a seat belt designed to restrain a child restraint or by using **LATCH**. Many seat belts are **NOT** safe to use with this child restraint, even though they can easily be threaded through or around the child restraint! Vehicle seat belt system **MUST** hold child restraint securely. Not all vehicle seat belts can be used with a child restraint. If vehicle seat belt does not hold child restraint securely, read "7.0 Choosing An Appropriate Vehicle Seat Location, p. 22-26".
5. **PROPERLY SECURING YOUR CHILD IN THE CHILD RESTRAINT.**
 - **NEVER LEAVE YOUR CHILD UNATTENDED.**
 - **YOU MUST READ** your vehicle owner's manual on child restraint use.
 - **REAR-FACING** child restraint must be properly leveled:
 - Too reclined can result in injury or ejection.
 - Too upright can result in breathing difficulties.
 - **NEVER LEAVE CHILD UNATTENDED**, even when sleeping. Child may become tangled in harness straps and suffocate or strangle.
 - According to accident statistics, **CHILDREN ARE SAFER WHEN PROPERLY RESTRAINED IN REAR VEHICLE SEATING POSITION, RATHER THAN FRONT SEATING POSITIONS.** For a vehicle with a front passenger air bag, refer to your vehicle owner's manual as well as these instructions for child restraint installation.
 - **SECURE CHILDREN** in rear seat of vehicle whenever possible.

- **SERIOUS CRIPPLING INJURY OR DEATH** can result if infant faces front of vehicle. The American Academy of Pediatrics (AAP) recommends that children be *rear-facing* until age 2 or until they reach the maximum *rear-facing* height and weight rating for their seat.
- **SOME SPECIAL NEEDS CHILDREN**, such as pre-term babies or those who have tested positive for positional apnea, may be at increased risk of suffering breathing or other difficulties in a child restraint. If your child has special needs, we recommend that you have your physician or hospital staff evaluate your child and recommend the proper child restraint or car bed before using this product.
- **DO NOT** remove **LATCH** system from child restraint. If using vehicle seat belt to secure child restraint, **LATCH** connectors must be stored. (see section “**14.0 TETHER AND LATCH STORAGE**, p. 39”.)
- **NEVER ATTACH** two **LATCH** connectors to one vehicle lower anchor point unless specifically allowed by the vehicle manufacturer.

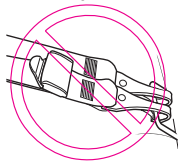

- **DO NOT INSTALL OR USE THIS CHILD RESTRAINT AND BASE UNTIL YOU READ AND UNDERSTAND THE INSTRUCTIONS IN THIS MANUAL AND IN YOUR VEHICLE OWNER'S MANUAL. DO NOT** let others install or use the child restraint unless they understand how to use it.
- **IF CHILD RESTRAINT IS IN A CRASH**, it must be replaced. **DO NOT** use it again! A crash can cause unseen damage and using it again could result in serious injury or death. **DO NOT** use child restraint if it is damaged or missing parts. **DO NOT** use a cut, frayed or damaged child restraint harness, vehicle seat belt or **LATCH** belts.
- **NEVER LEAVE A CHILD RESTRAINT** and base unsecured in your vehicle. An unsecured child restraint or base can be thrown around and may injure occupants in a sharp turn, sudden stop or crash. Remove it or make sure that it is securely belted in the vehicle. If not using **LATCH**, make sure unsecured **LATCH** connectors are properly stored on base.
- **NEVER GIVE THIS CHILD RESTRAINT** to someone else without also giving them this manual.

- **DO NOT** use accessories or parts other than those provided by Graco. Their use could alter the performance of the child restraint.
- **NEVER USE A SECOND-HAND CHILD RESTRAINT** or a child restraint whose history you do not know.
- **DO NOT MODIFY YOUR CHILD RESTRAINT** or use any accessories or parts supplied by other manufacturers.
- **THE CHILD RESTRAINT CAN BECOME VERY HOT IF LEFT IN THE SUN.** Always touch the surface of any metal or plastic parts before putting your child in the child restraint.
- **DO NOT** use child restraint with any stroller.
- **DO NOT** allow the liquid in the level indicator to be ingested or come into contact with the eyes.

Model Number: _____

Date of Manufacture: _____

Purchase Date: _____

2.1 Register Your Child Restraint

Please fill in the above information. The model number and date of manufacture can be found on a label on the child restraint. Fill out the prepaid registration postcard attached to the harness and mail it today.

Child restraints could be recalled for safety reasons. You must register this restraint to be reached in a recall. Send your name, address, and the restraint's model number and date of manufacture to:

Graco Children's Products Inc.

Attn: Customer Service, 3 Glenlake Parkway, Atlanta, GA 30328

or call 1-800-345-4109 or register online at:

<http://www.gracobaby.com/carseatregistration>

2.2 For Recall Information

Call the U.S. Government's Vehicle Safety Hotline at: 1-888-327-4236 (TTY:1-800-424-9153), or go to <http://www.NHTSA.gov> or contact Graco:

1-800-345-4109

or www.gracobaby.com

2.3 If You Need Help

Please contact our Customer Service Department with any questions you may have concerning parts, use, or maintenance. When you contact us, please have your product's model and date of manufacture ready so that we may help you efficiently. These numbers can be found on a label on the child restraint.

USA: 1-800-345-4109
or www.gracobaby.com
www.cpsc.gov
www.NHTSA.gov
www.seatcheck.org

3.1 Certification

THIS CHILD RESTRAINT CONFORMS to all applicable requirements of Federal Motor Vehicle Safety Standard 213 and is certified for use in motor vehicles.

3.2 Child Restraint Useful Life

STOP using this child restraint and throw it away 10 years after the date of manufacture. Look for this sticker on rear of child restraint:

MODEL	NAME		
Date of Manufacture	year	month	day
GRACO CHILDREN'S PRODUCTS, INC.			
ATLANTA, GA 30328		1-800-345-4109	
Made in China			

3.3 Second Hand Child Restraint

Graco Children's Products Inc. advises against loaning or passing along a child restraint.

4.1 Attaching LATCH Storage Compartment

WARNING

NEVER use without **LATCH** storage compartment or cupholder attached.



- Insert **LATCH** storage compartment under metal tube into bottom of base as shown **A**.
- Line tabs on bottom of **LATCH** storage compartment with openings in child restraint **B**.
- Push into base until you hear a click **C**.

4.2 Attaching Cupholder

WARNING

NEVER place sharp or pointed objects in a cupholder. In a crash, these objects could hit your child and cause serious injuries.

- Remove seat pad from right hand side of the child restraint as child sits in restraint **D**.
- Insert cupholder into opening in child restraint **E**.
- Rotate cupholder down, until you hear a click, to lock into place **F**.
- Wrap seat pad back around cupholder and side of child restraint **G**.
- Tuck fabric around cupholder and lock knob **H**.

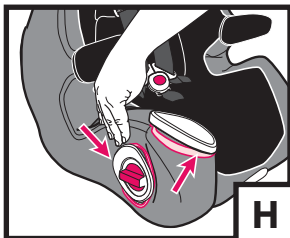
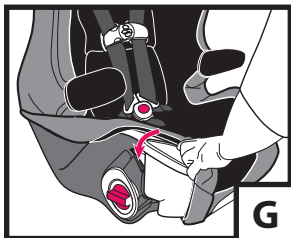
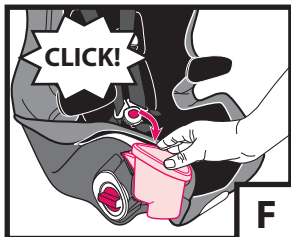
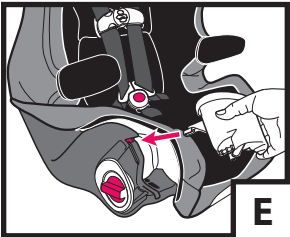
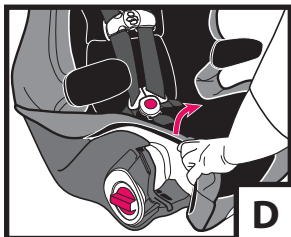
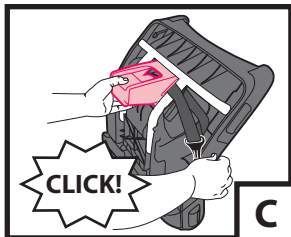
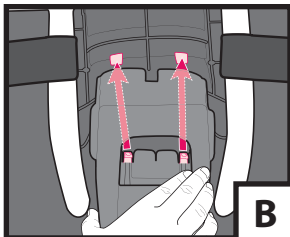
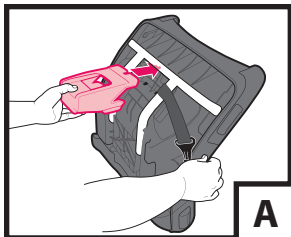

5.1 Child Restraint

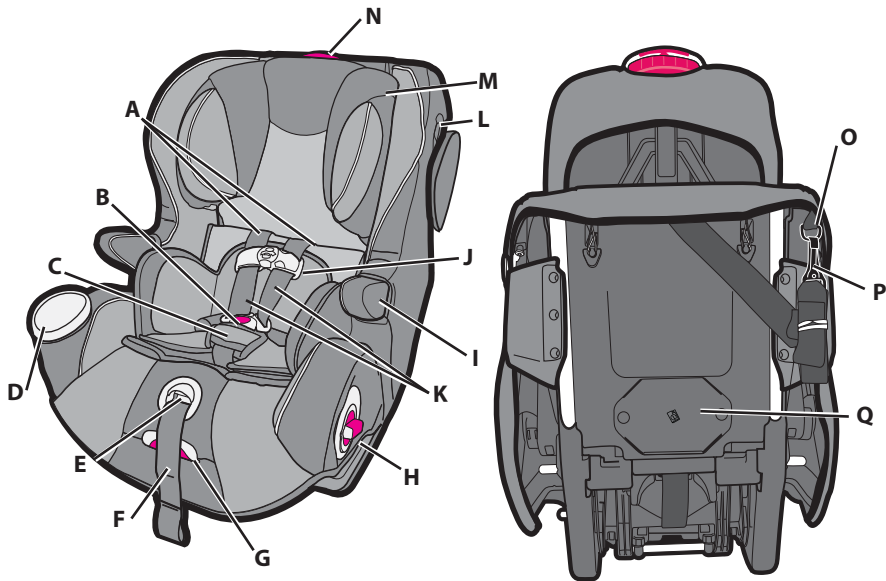

- A** Harness slots
- B** Harness buckle
- C** Crotch strap
- D** Cupholder
- E** Harness release lever
- F** Harness adjustment strap
- G** Recline handle
- H** Lock knobs
- I** Armrest
- J** Chest clip
- K** Harness strap
- L** Level indicator
- M** Head support
- N** Head support release
- O** Tether storage
- P** Tether *
- Q** Instruction manual storage

*Vehicles are now (or can be) equipped with tether anchor points behind some seats. A tether anchors the top of the child restraint to the body of the vehicle. When used properly with the vehicle seat belt or **LATCH**, a tether helps reduce injury in a sudden stop or crash.

5.2 BASE

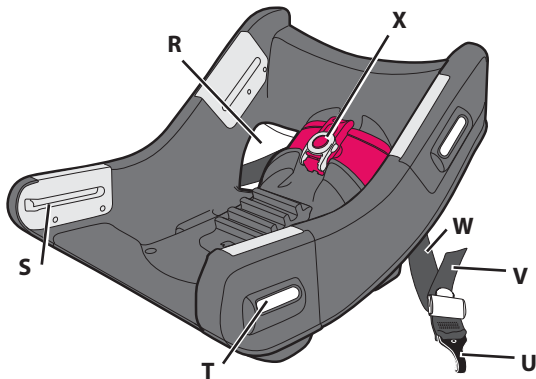

NOTE: Only use base with Smart Seat™ All-In-One Carseat.

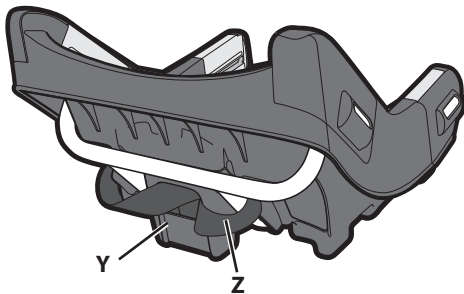

- R** Vehicle belt/**LATCH** path
- S** Child restraint pin guides
- T** Lock identification window
- U** **LATCH** connector
- V** **LATCH** adjustment belt
- W** **LATCH** belt **
- X** Seat belt lock-off
- Y** **LATCH** storage compartment
- Z** **LATCH** (stored)

United States Federal Motor Vehicle Safety Standards have defined a system for installing child restraints in vehicles. The system is called **LATCH. **LATCH** may **ONLY** be used **IN PLACE** of vehicle belt if vehicle is equipped with **LATCH** anchor points. Please refer to vehicle owner's manual for **LATCH** in vehicles.

⚠ WARNING

FAILURE TO USE CHILD RESTRAINT IN A MANNER APPROPRIATE FOR YOUR CHILD'S SIZE MAY INCREASE THE RISK OF SERIOUS INJURY OR

DEATH. Instructions for the use of this child restraint differ greatly depending on the size of your child. Be sure you are using the child restraint in the correct mode and with the correct features for your child.

Rear-Facing with base



4 lbs-20 lbs
(1.8 kg-9 kg)

and up to
1 year

**MUST BE
REAR
FACING**

20 lbs-40 lbs
(9 kg-18.1 kg)

and

Top of head
AT LEAST 1"
(2.54 cm)

BELOW top of
head support

Body support
MUST be used
if shoulders are
below lowest
harness
setting.

Forward-Facing with base



20 lbs-39 lbs
(9 kg-17.7 kg)

At least 1 year
old and can
sit upright
unassisted

40 lbs-65 lbs
(18.1 kg-29.5 kg)

**MAX HEIGHT
50" (127 cm)**

Shoulders are
BELOW top harness
slot position

Booster WITHOUT Base



30 lbs-65 lbs
(13.6 kg-29.5 kg)

**MIN. HEIGHT
38" (96 CM)**

IF Shoulders are
ABOVE top
harness slot position

65 lbs-100 lbs
(29.5 kg-45 kg)

**MAX. HEIGHT
57" (145 CM)**

Top of ears are **BELOW**
top of booster seat

approx. 3-10 years

6.1 Rear-facing with base: 4 to 40 lbs. (1.8-18.1 Kg)

- Infants who weigh less than 20 lbs. (9 kg) and at least 1 year of age **MUST** be **rear-facing**.
- Infants or toddlers 20 to 40 lbs. (9 to 18.1 kg) may be **rear-facing**.
- Harness height must be below child's shoulders
IMPORTANT: This child restraint is certified for use **rear-facing** with children up to 40 lbs. (18.1 kg). However, some children approaching 40 lbs. (18.1 kg) may be too tall to fit **rear-facing**. Top of head must be at least 1" (2.54 cm) below the top of the head support.
- Child should use child restraint **forward-facing** only if child is over 20 lbs. (9 kg) and can sit upright unassisted. (*)

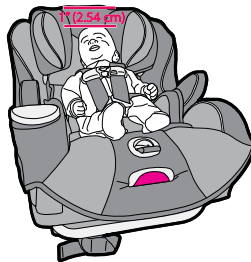

*The American Academy of Pediatrics (AAP) recommends that children be **rear-facing** until age 2 or until they reach the maximum **rear-facing** height and weight rating for their seat.

Preterm or Low Birthweight Infants

A preterm infant or low birth weight infant may be at special risk in a vehicle or aircraft. According to the American Academy of Pediatrics, these infants may suffer breathing difficulties if improperly reclined in a child restraint. Graco advises that you have your physician or hospital staff evaluate your infant and recommend the proper child restraint or car bed before you and your infant leave the hospital.

6.2 Forward-facing with base: 20 to 65 lbs. (9 to 29.5 kg)

WITH BUILT-IN HARNESS SYSTEM:

- Child must not exceed 50 inches (127 cm)
 - At least one year old.
 - Toddlers 20 to 65 lbs. (9 to 29.5 kg) who are capable of sitting upright unassisted may be **forward-facing**. If unable to sit upright unassisted, use **rear-facing** when below 40 lbs. (*)
 - Toddlers 40 to 65 lbs. (18.1 to 29.5 kg) and up to 50 inches (127 cm) tall **MUST** be **forward-facing**.
 - Shoulders are **BELOW** top harness slot/head support height. If shoulders are above harness slots, child is too large for **forward-facing** with built-in harness.
- (* , see p. 19 American Academy of Pediatrics (AAP) recommendations)

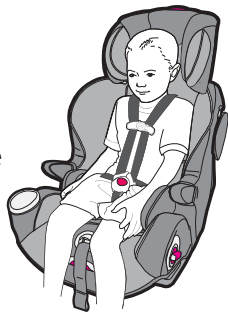

6.3 Booster *WITHOUT* base: 30 to 100 lbs. (13.6 to 45 kg)

WITHOUT BUILT-IN HARNESS SYSTEM:

Harness **MUST** be stored during Booster mode, see "19.1 Storing Harness, p. 52".

- Height: 38 to 57 inches (96 and 145 cm)
 - Approximately 3-10 years of age
 - The shoulder belt **MUST** lie across child's shoulder as shown and the lap portion of the belt is positioned low on the child's hips.
 - Child's ears are **BELOW** top of head support. If tops of ears are above top of head support, child is too large for booster seat.
- **If child is between 30 and 65 lbs (13.6 and 29.5 kg) and shoulders are below the upper harness slots, we highly recommend using in **forward-facing** mode with built-in harness for as long as possible (up to 65 lbs).**

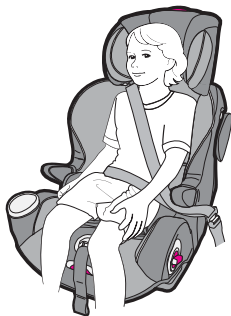

7.1 Vehicle Seat Location Requirements



WARNING

IMPROPER PLACEMENT OF THE CHILD RESTRAINT INCREASES THE RISK OF SERIOUS INJURY OR DEATH. Some seating

positions in your vehicle may not be safe for this child restraint. Some vehicles do not have any seating positions that can be used safely with the child restraint. If you are not sure where to place the child restraint in your vehicle, consult your vehicle owner's manual or call Graco Children's Products Inc., at 1-800-345-4109.

- **Children are safer when properly restrained in rear vehicle seating positions.**

Whenever possible secure the child restraint in the center position of the seat directly behind the front seats. However, this position is sometimes equipped with a lap belt only and cannot be used when this child restraint is used without the built-in harness.



- **The vehicle seat must face forward.** Do not use child restraints on rear-facing or side-facing vehicle seats.

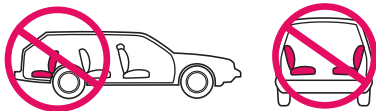

7.2 Vehicle Seat Belt Requirements



MANY SEAT BELT SYSTEMS ARE NOT SAFE TO USE WITH THE CHILD RESTRAINT. THE VEHICLE SEAT BELT MUST BE DESIGNED TO HOLD THE CHILD

RESTRAINT TIGHTLY AT ALL TIMES. DO NOT USE A VEHICLE BELT THAT CHANGES LENGTH WHILE DRIVING. Pay careful attention to these systems; some of the seat belts that are not safe to use look very much like seat belts that are safe to use. If you are unsure, consult your vehicle owner's manual or call Graco Children's Products Inc., at 1-800-345-4109.

7.3 SAFE Vehicle Seat Belt Systems

THE FOLLOWING BELT SYSTEMS CAN BE USED WITH YOUR CHILD RESTRAINT, IF the seat location meets all other requirements of these instructions and those in your vehicle owner's manual. **LATCH** can be used in place of the following vehicle belt systems if your vehicle is equipped with **LATCH** anchor points. Please refer to vehicle owners manual for **LATCH** locations.

7.4 For Built-in Harness Only

- **Lap Belts** - Manually adjusted when buckled, the belt is tightened manually by pulling on the free end.
- **Lap Belts with Automatic Locking Retractor (ALR)** - The automatic locking retractor will not permit the lap belt to lengthen once it is buckled. Tighten the belt by feeding the belt back into the retractor while pushing down hard on the child restraint.

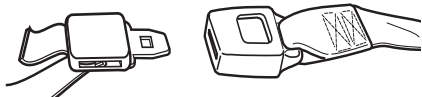

7.5 With or Without Built-in Harness

- **Combination Lap/Shoulder Belt with Locking Latch Plate** - Once it is buckled, this type of belt has a latch plate that will not allow the lap portion of the belt to loosen. Belt is tightened by pulling hard on the shoulder portion of the vehicle belt while pushing down hard on the child restraint.
- **Combination Lap/Shoulder Belt with Sliding Latch Plate** - This belt has a latch plate that slides freely along the belt.

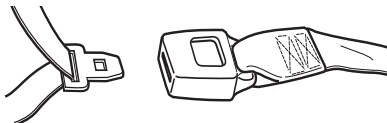

7.6 UNSAFE Vehicle Belt Systems

DO NOT USE ANY OF THE FOLLOWING SYSTEMS TO SECURE THE CHILD RESTRAINT. **LATCH** can be used **IN PLACE OF** the following unsafe belt systems if your vehicle is equipped with **LATCH** anchor points. Please refer to the vehicle owners manual for **LATCH** locations. **NEVER USE** unsafe belt systems.

- **Lap Belts with Emergency Locking Retractor (ELR)**

This lap belt stays loose and can move until it locks in a crash or sudden stop.

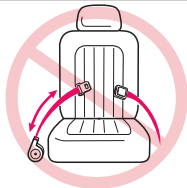

- **Combination Lap/Shoulder Belt with Retractor**

Each strap has a retractor at one end and is attached to the latch plate at the other end.

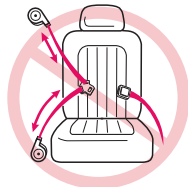

- **Passive Restraint - Lap or Shoulder Belt Mounted on Door**



- **Passive Restraint -**

Lap Belt with Motorized Shoulder Belt

DO NOT use vehicle belts that are attached to the door in any way or that move along a track to automatically surround the passenger when the door is closed.

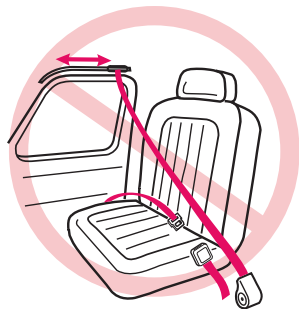

- **Lap Belts Forward of Seat Crease**

Vehicle seat belts located forward of seat crease may not securely hold child restraint. Check vehicle owner's manual or see vehicle dealer for car seat installation requirements.

• If approved for use with child restraint, install child restraint and check for secure installation by pulling child restraint front to back. If child restraint slides forward, DO NOT use these seat belts.

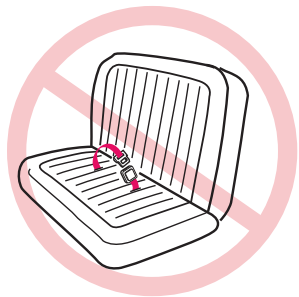

8.1 What is LATCH?



United States Federal Motor Vehicle Safety Standards have defined a system for installing child restraints in vehicles. The system is called **LATCH**.

LATCH stands for: **L**ower **A**nchors and **T**ethers for **C**hildren.

LATCH in the vehicle consists of a top tether anchor point and two lower anchor points.

Some vehicle owner manuals use the term **ISOFIX** to identify the new child restraint anchor system. This child restraint with **LATCH** can also be used in vehicle seating positions equipped with **ISOFIX**.

Newer vehicles have one or more seating positions with **LATCH** anchor points. If vehicle is equipped with **LATCH**, the vehicle lower anchor points may be visible at the vehicle seat crease. If not visible, they may be marked with this symbol .

CHECK vehicle owner's manual for vehicle top tether anchor locations. They may be identified using one of the anchor symbols as shown  .

ONLY use **LATCH** on a child restraint in a seating position recommended by vehicle manufacturer.

NOTE: Some vehicle manufacturers have lower maximum weight ratings for **LATCH** anchors, so you must consult your vehicle owner's manual or call the vehicle manufacturer to confirm the limits on your vehicle's **LATCH** anchors.

Use vehicle belt (not **LATCH** connectors) for installations with children weighing more than 48 pounds (21.7 kg).

See your vehicle owner's manual for exact locations, anchor identification, and requirements for use with a child restraint.

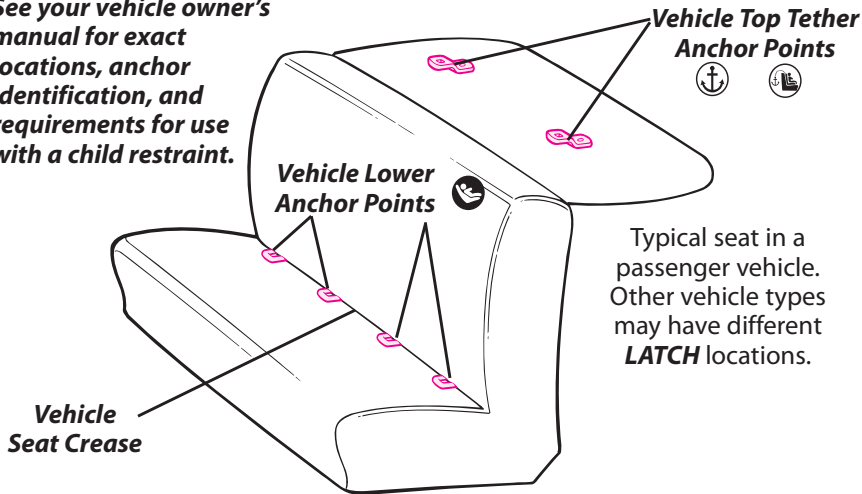

Typical seat in a passenger vehicle. Other vehicle types may have different **LATCH** locations.

8.2 LATCH System

LATCH consists of a permanently attached lower anchor belt and a top tether strap.

ONLY use **LATCH** in a seating position recommended by vehicle manufacturer.

LATCH lower vehicle anchor points are defined as 11 inches from the center of one **LATCH** anchor to the center of another **LATCH** anchor.

If allowed by your Vehicle Owners Manual, the center seating position maybe used if the anchor spacing is 11" or greater.

REAR-FACING

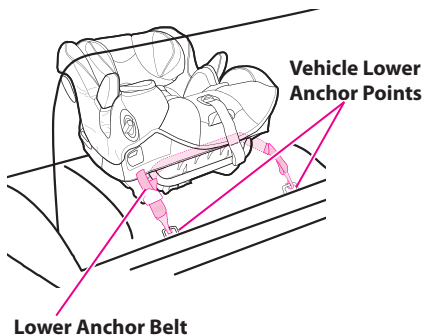

FORWARD-FACING

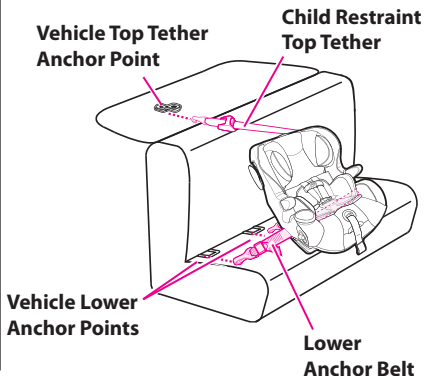

You must carefully follow the instructions provided by your vehicle manufacturer, in addition to the information in this manual. Before proceeding be sure you have read and understood, ***“7.0 Choosing an Appropriate Vehicle Seat Location” on pages 22-26.***

Make sure vehicle is on level ground **A** and not like in picture **B**.

If a front passenger seat is used (***see air bag warning, page 4***), slide the vehicle seat rearward as far as possible from the dashboard. If a rear seat is used, make sure the seat in front of it is moved forward enough and is upright enough to allow room for the child restraint.

When using the vehicle seat belts to install the base, the lock-off is **ALWAYS** used to secure both belts of the lap or lap/shoulder belt.

1. Position base in vehicle seat as shown **C**.
2. Open the lock-off and route the vehicle belt through the belt path and over the lock-off **D**.
3. Buckle seat belt. Pull up on shoulder belt while pushing down on base to tighten **E**.
4. Close lock-off **F**.
5. Test base for secure installation by moving front to back and left to right at the belt path **G**. Base should not move more than 1 inch (2.54 cm). If belt loosens or lengthens, repeat procedure.

Lap Belt **H** and Lap/Shoulder Belt **I** should appear as shown when installed.

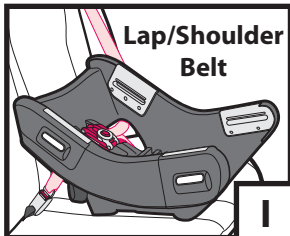
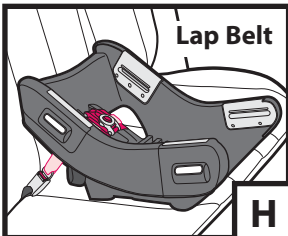
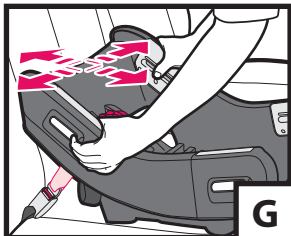
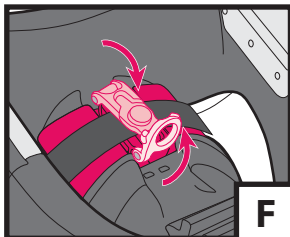
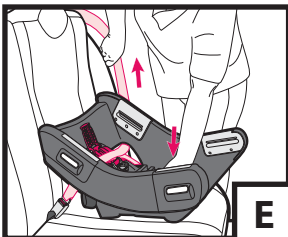
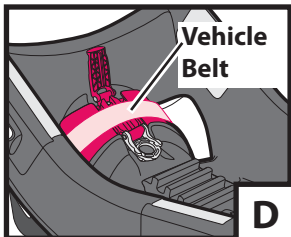
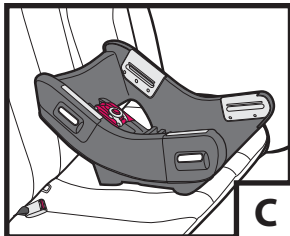
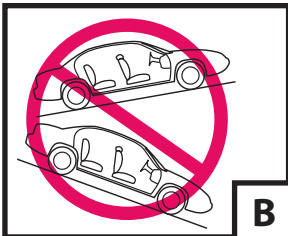
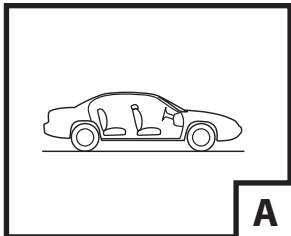

1. Remove **LATCH** from storage area **A**. For ease of installation, extend **LATCH** to its maximum length.
2. Place base in vehicle seat as shown **B**.
3. Make sure **LATCH** is routed through vehicle/**LATCH** belt path normally used for vehicle seat belt.

Belt must lay flat and not be twisted.

4. Hook **Connectors** to vehicle lower anchors. Pull firmly on **Connectors** to be sure they are attached **C**.
5. **NEVER** put two **LATCH** connectors on one vehicle **LATCH** anchor unless specifically allowed by the vehicle manufacturer **D**.
6. With base flat on vehicle seat, slide back until top of base contacts seat back. Make sure that base bottom remains flat on the vehicle seat **E**.
7. Tighten **LATCH** by pushing down hard on the center of the base and pulling the free end of the adjustment belt **F**.
8. Test base for secure installation by moving front to back and left to right at the belt path **G**. Base should not move more than 1 inch (2.54 cm). If belt loosens or lengthens, repeat procedure.
9. Check that the **LATCH** stays tight and does not slip from the tightened position. If it does not stay tight, try another seating position or contact Graco at 1-800-345-4109.
10. To remove **LATCH** lift up on metal tongue of buckle and remove **LATCH** as shown **H**.

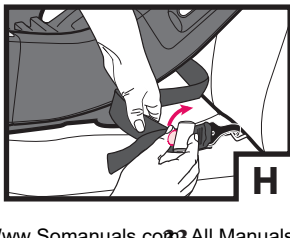
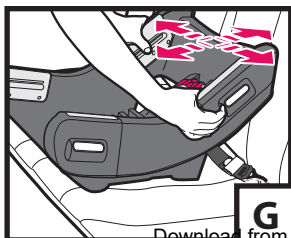
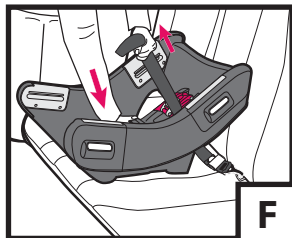
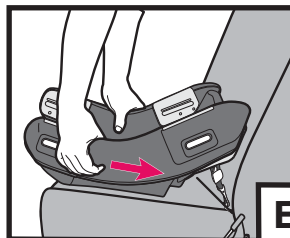
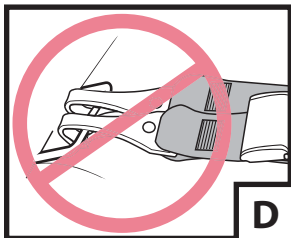
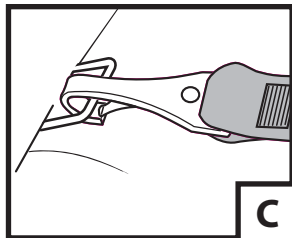
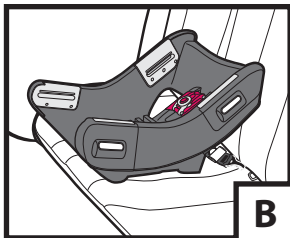
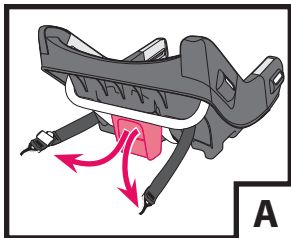

1. Test base for secure installation. **See sections 9.0 and 10.0 for base installation, p. 30-33 A.**
2. Push in **B** and rotate knobs **C** on both sides of child restraint at the same time to unlock position.
3. Place child restraint on base in rear-facing position **D**.
4. Rotate knobs on both sides of child restraint to lock it into base **E**. You will see lock symbols in windows on side of base as shown **H**.
5. If you see the red flags up in the child restraint seating area **F** and you see the unlock symbol **I** then seat is not secured to base.
6. Check seat is secure by moving front to back and left to right at the belt path **G**. Base should not move more than 1 inch (2.54 cm). If belt loosens or lengthens, repeat procedure.



A

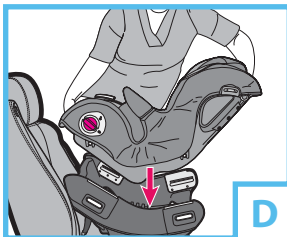

D

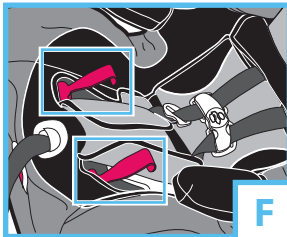

F

NOTE: Make sure tether is stored. See "14.1 Tether Storage", p. 39. You can not use tether in rear-facing mode.

NOTE: Bubble in level indicator must be fully between the two lines J. Level indicator is for rear-facing use only. See "17.0 Using Recline", p. 46

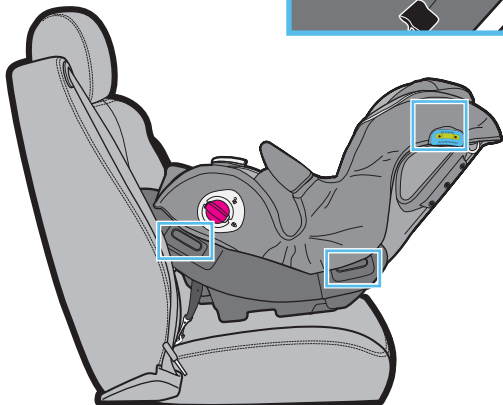
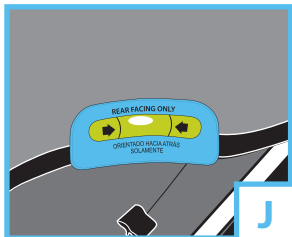
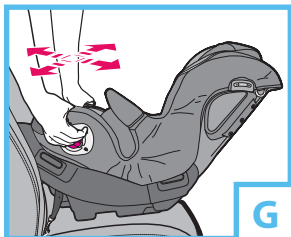
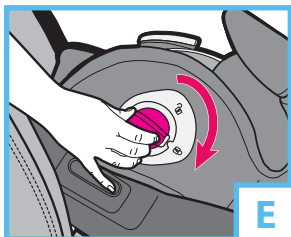
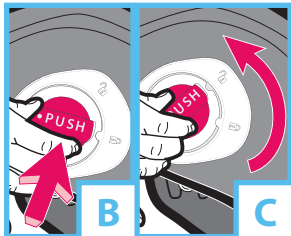

1. Test base for secure installation. **See sections 9.0 and 10.0 for base installation, p. 30-33 A.**
2. Push in **B** and rotate knobs **C** on both sides of child restraint to unlock position.
3. Place on base in forward-facing position **D**.
4. Rotate knobs on both sides to lock seat to base **E**. You will see lock symbols in windows on side of base as shown **H**.
5. If you see the red flags up in the child restraint seating area **F** and you see the unlock symbol **I** then seat is not secured to base.
6. Check seat is secure by moving front to back and left to right at the belt path **G**. Base should not move more than 1 inch (2.54 cm). If belt loosens or lengthens, repeat procedure.

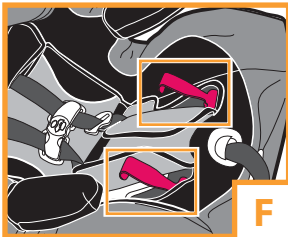
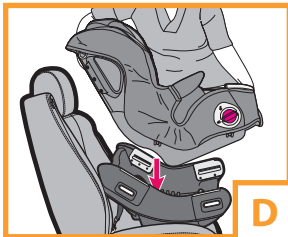

Note: See “13.0 Tether Use”, p. 38 to attach tether.

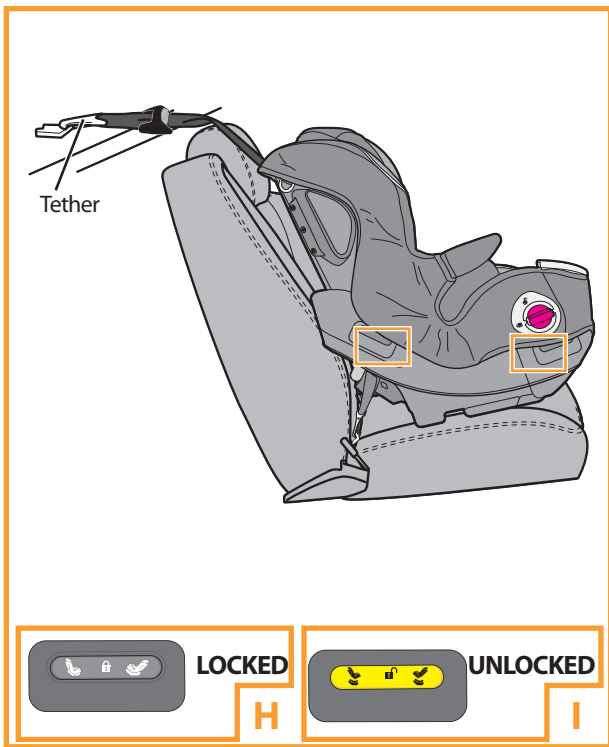
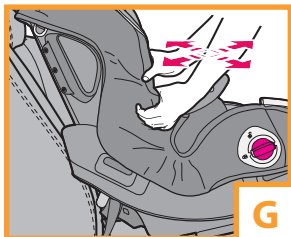
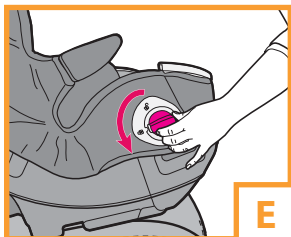
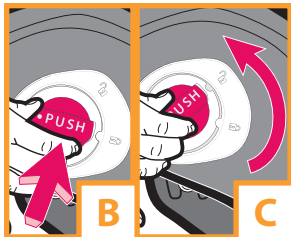

All **LATCH** seating positions have tether anchors. Always use tether if a vehicle tether anchor is available in forward-facing mode with harness. Check your vehicle owner's manual for the tether anchor location(s). If your vehicle is not equipped with a tether anchor, it may be possible to install one. Contact your vehicle dealership for the proper anchor location and installation.

NOTE: TETHER NOT TO BE USED IN REAR-FACING MODE.

1. Check that tether is securely attached to child restraint.
2. Fasten tether clip to anchor point **A**.
3. Tighten adjustment belt to remove any slack **B**.
4. To loosen, push button while pulling on the belt as shown **C**.

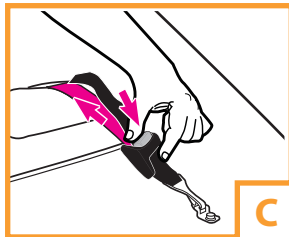
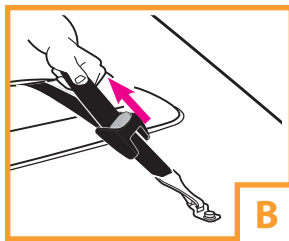
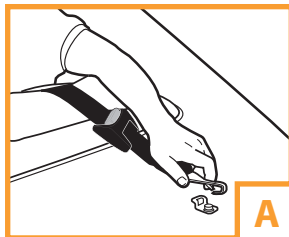

14.1 Tether Storage

Tether must be stored to child restraint for rear-facing use.

- Store tether on D-ring on seat pad as shown **A**.
- Pull loose end of adjustment strap to remove any slack.
- Roll loose end of adjustment strap up and secure with a rubber band.

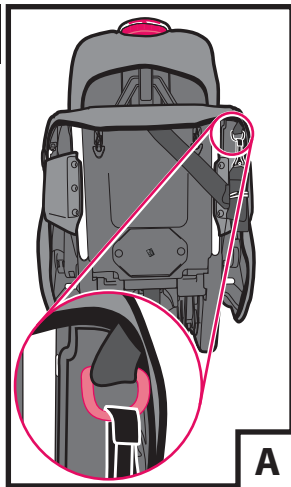

14.2 LATCH Storage

- To store **LATCH** belt, insert into **LATCH** storage compartment  on back of seat **B**.

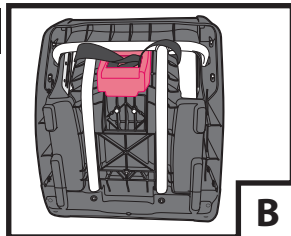

15.1 Harness Straps

- To tighten: Pull harness adjustment strap **A**.
- To loosen: Lift lever **B** while pulling shoulder harness straps **C**.

15.2 Chest Clip

- To open: Press tabs and pull apart **D**.
- To close: Snap halves together **E**. Make sure the chest clip is locked by pulling out on each half.

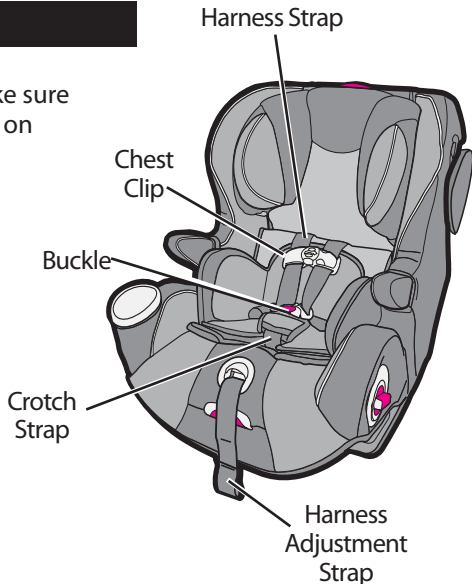

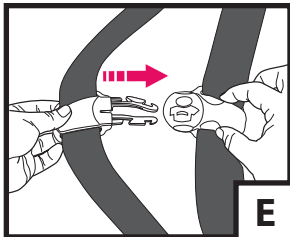
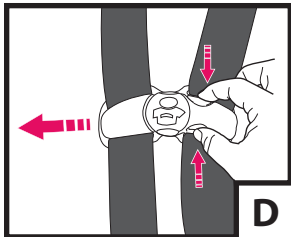
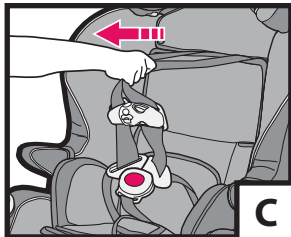
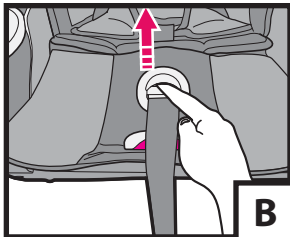
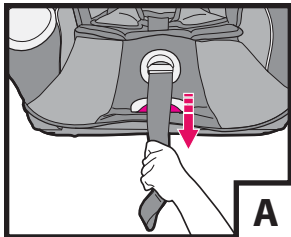

15.3 Buckle

- To buckle: Insert both tongues into buckle. Pull up on tongues to be sure they are locked **F**.

To tighten: Pull harness adjustment strap **G**.

- To unbuckle: Loosen by lifting lever and pulling shoulder harness straps **H**. Tilt top of buckle toward seat **I** and press in at the top of the red button **J** and pull tongues out of buckle **K**.

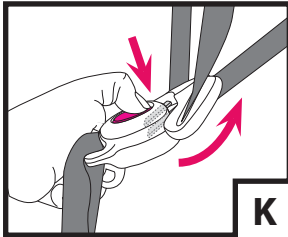
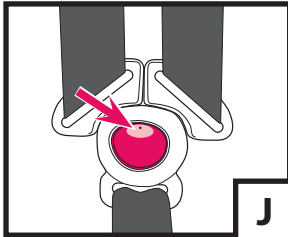
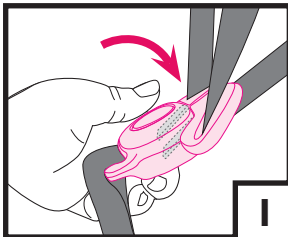
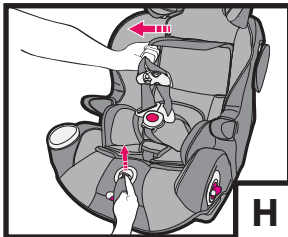
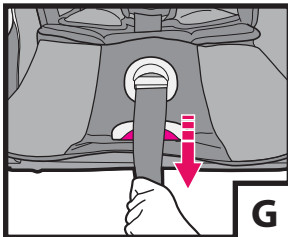
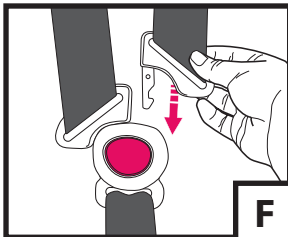

15.4 Crotch Strap

- Choose the crotch strap position that is closest to but not under your child.
- Push the clip at the end of crotch strap through bottom of seat and pull out through the seat and seat cover **L**.
- Reinsert in other crotch strap opening and push through seat cover and seat **M**.

CHECK buckle is securely installed by pulling up on crotch strap. The clip must be properly seated.

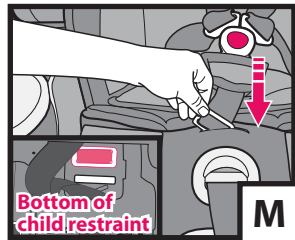
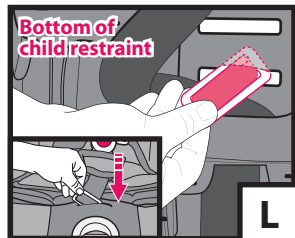

16.1 Body Support (on certain models)

⚠ WARNING

To prevent ejection in sudden stop or crash:

- Never allow body support to bunch or fold behind child.
- Only use body support in rear-facing mode.
- Body support **MUST** be used if shoulders are below lowest harness setting.

DO NOT use with children over 20lbs.

Flip body support and head pillow over. Slide head pillow under elastic strap on back of body support as shown **A**.

Do not use head pillow and body support with any other product.

Place in seat as shown.

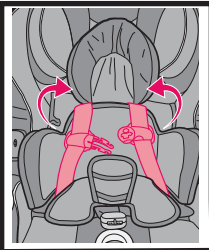
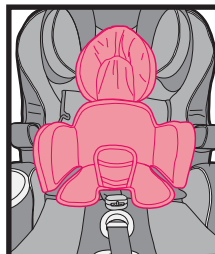
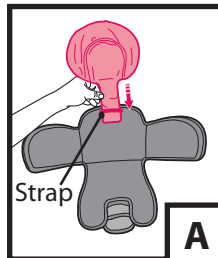
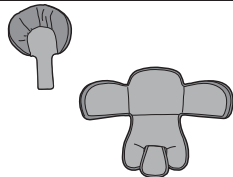

16.2 Harness Covers & Crotch Strap Cover (on certain models)

⚠ WARNING

To prevent serious head injury in sudden stop or crash:

- Always make sure shoulder straps are properly positioned on shoulders.
- Make sure that harness covers do not interfere with placement of the chest clip at armpit level.
- Harness covers are only to be used in rear-facing mode.

DO NOT use with children over 20lbs.

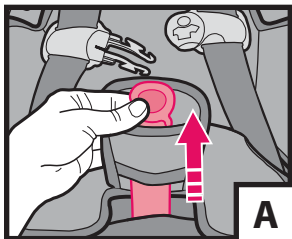

Pull buckle through crotch strap cover as shown **A**.

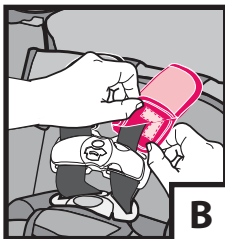
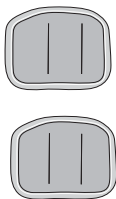

Wrap harness covers around the harness straps. Fasten hook and loop tape **B**.



FAILURE TO PROPERLY recline the infant restraint on the vehicle seat increases the risk of serious injury or death.

Recline only works in modes where child restraint is attached to the base.

REAR-FACING

1. Pull up on recline button on front of child restraint **A**.
2. Bubble in level indicator **C** must be fully between the two lines **D**. **E is not level.**
3. Vehicle must be on level ground and child in child restraint when checking level indicator.

NOTE: Level indicator is for rear-facing use only.

FORWARD-FACING



If using seat with child 40-65lbs, always use recline position 1.

1. Pull up on recline button on front of child restraint **B**.
2. Adjust recline to desired level indicated on label **F** on side of base **F**.

REAR FACING

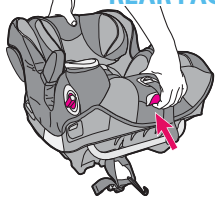

A

FORWARD-FACING

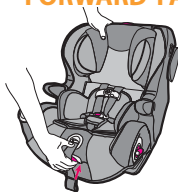

B

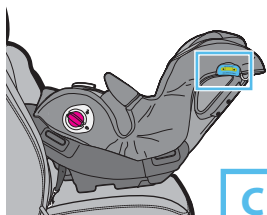

C

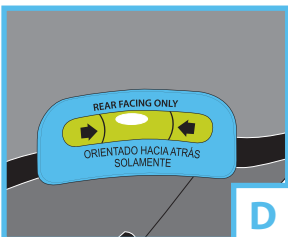

D

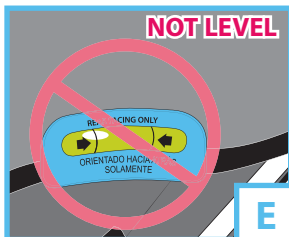

E

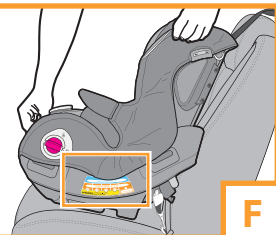

F

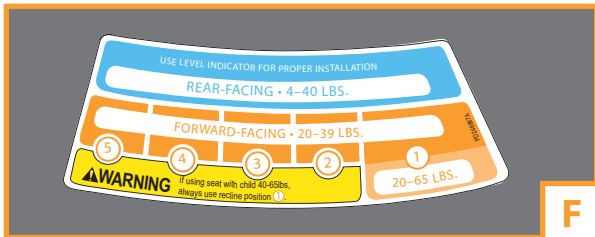

F

18.1 Placing Child in Child Restraint

1. Place child in child restraint **A** with child's back flat against back of child restraint. Avoid bulky clothing.
2. Place harness straps over child's shoulders and insert tongue(s) into buckle **B**.
3. Pull up on tongue(s) to be sure they are locked.
4. Close chest clip **C**:
Position chest clip at arm pit level.
5. Pull on harness adjustment strap to tighten straps as shown **D**. A snug strap should not allow any slack. It lies in a relatively straight line without sagging. It does not press on the child's flesh or push the child's body into an unnatural position.
6. **SAFETY CHECK :**
 - a) **MAKE SURE** the top of the child's head is at least 1" (2.54 cm) below the top of the infant restraint.
 - b) **CHECK** that harness straps are not twisted.
 - c) **CHECK** that the harness is snug. You should **NOT** be able to pinch **E** the harness if it is snug. A snug strap should not allow any slack. It lies in a relatively straight line without sagging. It does not press on the child's flesh or push the child's body into an unnatural position.
7. A rolled towel can be used on each side to support small children **F**. Be sure towels do not interfere with harness system. Towels should **NOT** be placed under child.

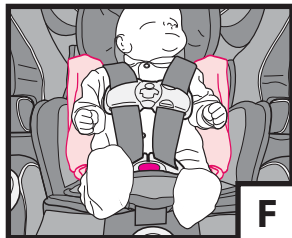
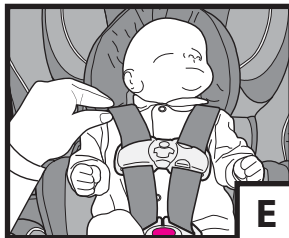
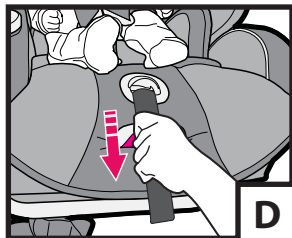
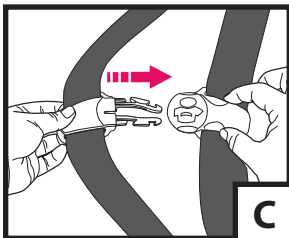
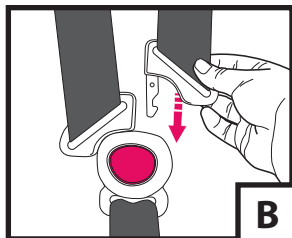
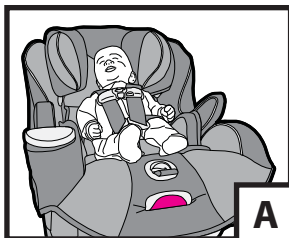
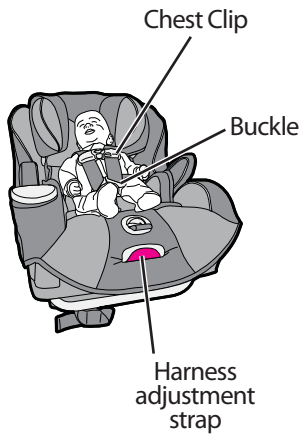

18.2 Check Harness System

WARNING

To prevent serious injury or death:

- Keep harness straps snug and positioned on shoulders with chest clip at arm pit level.
- Do not use strap covers, blankets, cushions, or padding under harness straps or child unless provided by Graco.
- Child should be dressed in clothing that does not interfere with buckling the harness.

REAR-FACING

- 4-40 lbs (1.8-18.1 kg)
Harness straps/head support must be in one of the bottom 3 height positions below the shoulders.
- Harness height must be below child's shoulders.
- Body support **MUST** be used if shoulders are below lowest harness setting.

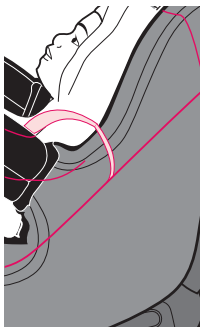

FORWARD-FACING

- 20-65 lbs (9.1-29.5 kg)
and at least one year old.
Harness straps/head support must be in one of the top 4 height positions, at or above shoulders.
- Harness height must be at or just above child's shoulders.

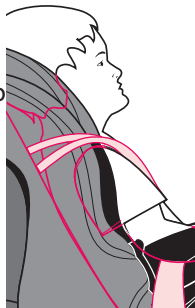

18.3 Adjusting Head Support/ Harness Straps

⚠ WARNING

Failure to properly adjust the harness straps for your child increases the risk of serious injury or death in the event of a sharp turn, sudden stop or crash.

- **BEFORE** adjusting the head support height, have your child lean forward slightly.
- Squeeze the red adjustment handle **A** on top of seat and pull head support up until it snaps into one of the 6 height positions.
- To lower, squeeze red adjustment handle and push head support down.
- **CHECK** to make sure it is securely snapped into one of the 6 height positions by pulling up on head support.

When using in **rear-facing** mode always use one of the bottom 3 height positions **B**.

When using in **forward-facing** mode always use one of the top 4 height positions **B**.

Refer to page 50 for harness strap placement.

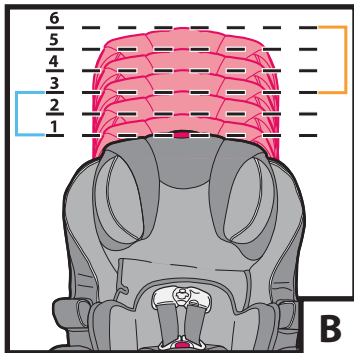
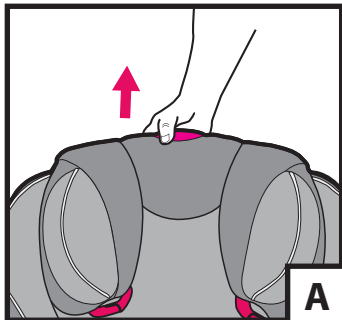

19.1 Storing Harness

Harness must be stored during Booster Mode.

1. Push the clip at the end of crotch strap through bottom of seat and pull out through the seat and seat cover **A**.
2. Rotate bottom of head support pad up and attach to back of head support pad with hook and loop tape **B**.
3. Disconnect snaps on seat cover **C**.
4. Move harness straps behind seat cover **D**.
5. Disconnect snaps or hook and loop tape (on certain models) and move shoulder straps behind head support pad **E**.
6. Open door behind seat cover **F**.
7. Insert harness buckle and crotch straps into harness storage compartment **G**.
8. Close door **H**.
9. Re-attach snaps on seat cover **I**.

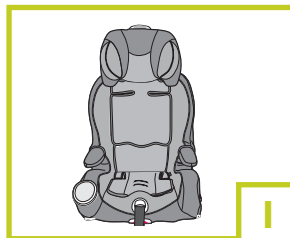
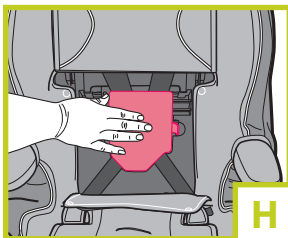
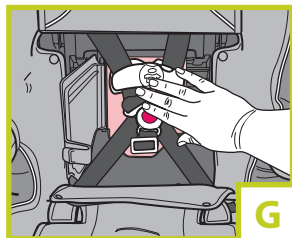
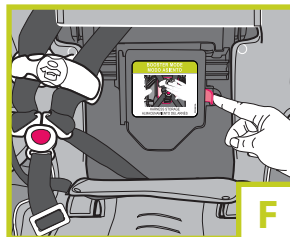
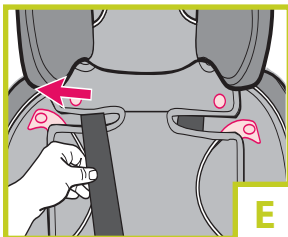
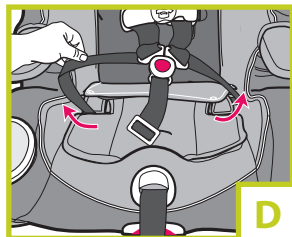
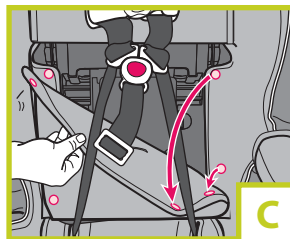
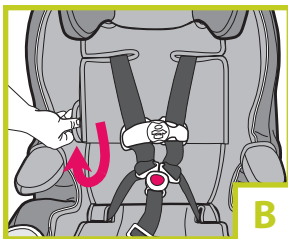
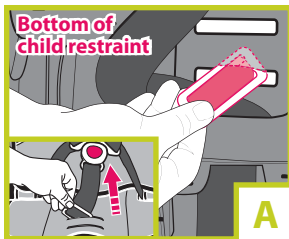

19.2 Using Child Restraint in Booster Mode



WARNING

Failure to properly secure your child in the child restraint increases the risk of serious injury or death in the event of a sharp turn, sudden stop or crash. In

a crash, the child restraint provides NO protection for your child unless the vehicle lap/shoulder belt is properly secured. Follow these instructions carefully to properly secure your child.

- Vehicle belts **MUST** lie flat against child and **MUST** not be twisted.
- **NEVER** use a vehicle lap-only belt across front of child **A**.
- **DO NOT** use shoulder belt loose or positioned under arm **B**.
- **DO NOT** place shoulder belt behind child's back **C**.
- Lap portion of lap/shoulder belt **MUST** be low and snug on hips, just touching thighs.
- **DO NOT** allow child to slide down in booster seat **D**.
- If child will not keep vehicle belt properly positioned, **DO NOT** use this booster seat. Use a different child restraint system.
- **DO NOT** position vehicle belt over top of the armrests **E**.
- Vehicle seat head support should not create a gap between vehicle seat and booster seat **F**. The front of booster seat **MUST NOT** hang over front of vehicle seat **G**.
- **DO NOT** place child in booster if flags are up in the seat area **H**.
- **DO NOT** use in Booster mode with base **I**.

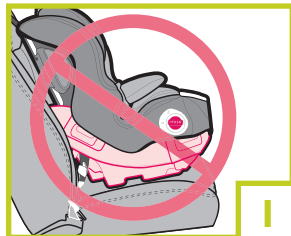
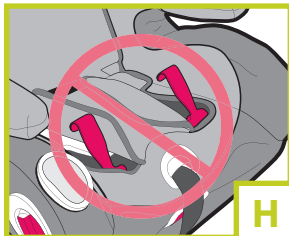
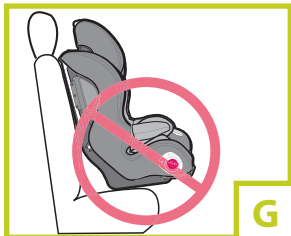

19.3 Securing Child in Booster Seat and Vehicle



WARNING

USE ONLY the vehicle lap and shoulder belt system when restraining the child in the booster seat.

1. Remove base from vehicle seat **A**.
2. Place booster seat firmly against the back of a forward-facing vehicle seat equipped with a lap/shoulder belt only **B**.
3. Place child in booster seat with child's back flat against back of booster seat.
4. Position lap/shoulder belt through shoulder belt guide **C** not underneath shoulder belt guide. Fasten buckle and pull up on the shoulder belt to tighten. Be sure lap portion of the belt goes under armrests **D**.
5. If shoulder belt lies across child's neck, head or face, redirect shoulder belt over shoulder by adjusting the head support setting, see **"19.4 Adjusting Head Support in Booster Mode"**, p. 58.
6. The shoulder belt **MUST** lie across child's shoulders in red zone as shown **E**.

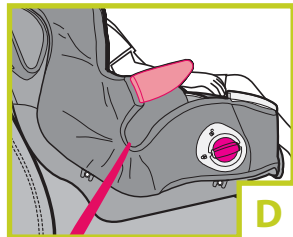
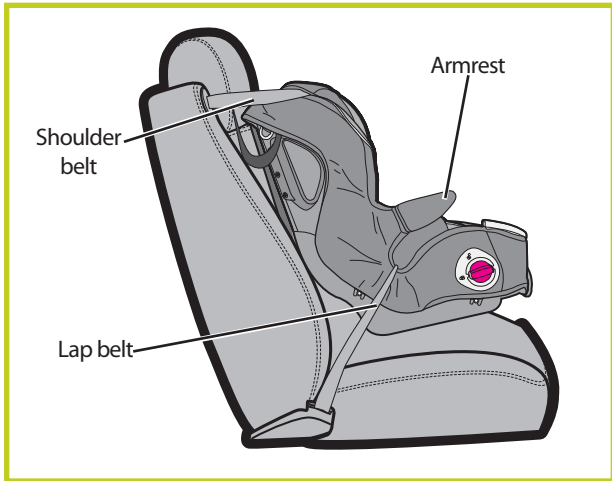
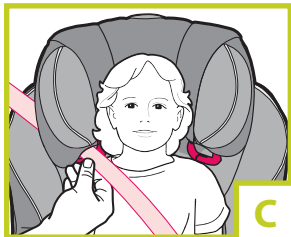
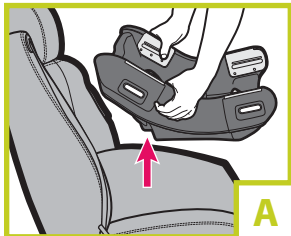

19.4 Adjusting Head Support in Booster Mode

When using in **booster** mode always use one of the top 4 height positions **A**.

- **BEFORE** adjusting the head support height, have your child lean forward slightly.
- Squeeze the red adjustment handle **B** on top of seat and pull head support up until it snaps into one of the 4 height positions.
- To lower, squeeze red adjustment handle and push head support down.
- **CHECK** to make sure it is securely snapped into one of the 4 height positions by pulling up on head support.
- **FOR PROPER FIT:** The shoulder belt guides should be even with or just above the shoulders **C**.

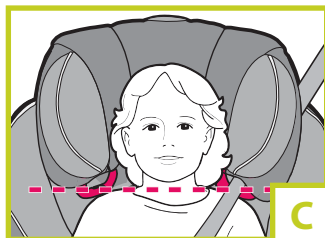
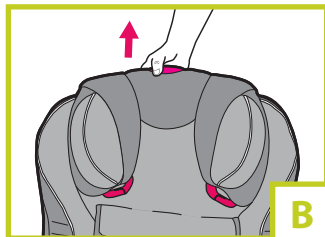
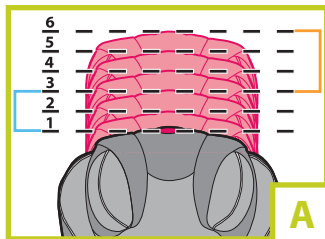

20.1 Adjusting Armrest

Armrest can be adjusted by pushing up or down on it **A**.

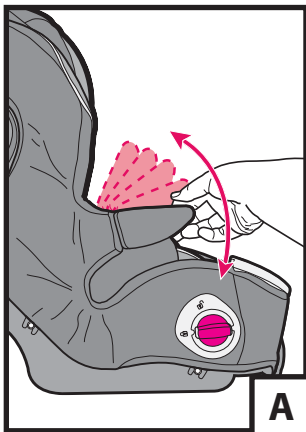

20.2 Removing Seat Cover

1. Store harness see **"19.1 Storing Harness"**, p. 52.
2. Remove elastic loops from seat as indicated in **A**.
3. Pull off cover taking care around the lock knobs, recline handle, level indicator and cup holder.
4. Machine wash cover in cold water on delicate cycle and drip-dry. **DO NOT USE BLEACH.**
5. To put the seat cover back on, reverse preceding instructions.

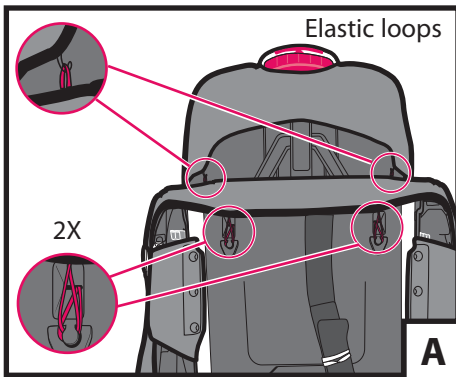

20.3 Airplane Use



- This child restraint system conforms to all applicable Federal Motor Vehicle Safety Standards.
- This Restraint is Certified for Use in Motor Vehicles.
- This Restraint is **NOT** Certified for Use in Aircraft.

20.4 Care and Maintenance

- Continuous use of child restraint may cause damage to vehicle seat. Use a child restraint mat, towel or thin blanket to protect upholstery.
- Metal and plastic parts: clean with mild soap and cool water. No bleach or detergents.
- Harness straps and **LATCH** straps: spot clean with damp sponge. Do not immerse the straps in water. Doing so may weaken the straps.
- If buckle or harness adjuster sticks or will not remain tight, check for foreign objects such as food, dirt, etc. Remove objects with tweezers and/or clean with a cotton swab. If you cannot get the harness to remain tight with the buckle securely locked, do not use this child restraint.

Buckle Cleaning Process:

WARNING

Prevent serious injury or death:

- Buckle must be properly latched.
- Periodically inspect and clean buckle to remove objects or debris that could prevent latching.

1. Turn restraint over, push retainer through crotch strap slot **(a)**.
 2. To clean buckle - place in a cup of warm water and gently agitate the buckle, press the red button several times while in the water **(b)**. **DO NOT SUBMERGE THE HARNESS WEBBING.** DO NOT USE SOAPS or LUBRICANTS. DO NOT use household detergents. Never lubricate buckle.
 3. Shake out excess water and allow to air dry, harness webbing should be dry before use **(c)**.
 4. Repeat Step 2 and 3 as needed. Buckle should fasten with a "click".
 5. Re-attach buckle into the same slot from Step 1.
- Re-check harness for correct installation before use.

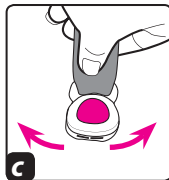
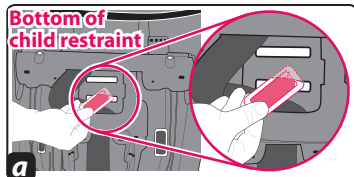

21.0 Replacement Parts, Warranty, and
Owner's Manual Storage

To purchase parts or accessories or for warranty information in the United States, please contact us at the following:

www.gracobaby.com

or

1-800-345-4109

Store instruction manual in the space provided on back of seat.

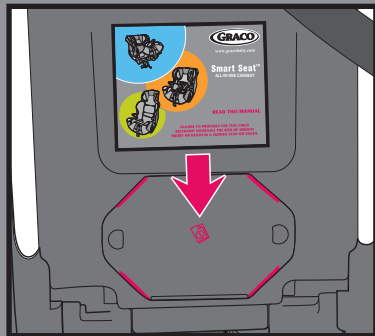

Free Manuals Download Website

<http://myh66.com>

<http://usermanuals.us>

<http://www.somanuals.com>

<http://www.4manuals.cc>

<http://www.manual-lib.com>

<http://www.404manual.com>

<http://www.luxmanual.com>

<http://aubethermostatmanual.com>

Golf course search by state

<http://golfingnear.com>

Email search by domain

<http://emailbydomain.com>

Auto manuals search

<http://auto.somanuals.com>

TV manuals search

<http://tv.somanuals.com>