

Instructions



# XTR™ Airless Spray Gun

309523D

## Part No. 233889, Series A

Heavy Duty RAC tip guard, 519 SwitchTip™

## Part No. 234032, Series A

Standard (nonreversing) Driplless™ tip guard, 519 flat tip

*7250 psi (50 MPa, 500 bar) Maximum Working Pressure*



**Read warnings and instructions.**

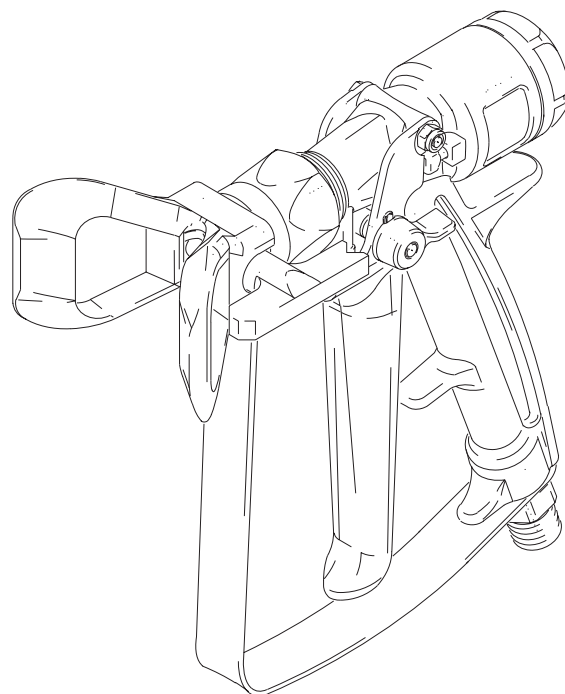

PROVEN QUALITY. LEADING TECHNOLOGY.

Graco Inc. P.O. Box 1441 Minneapolis, MN 55440-1441  
Copyright 2002, Graco Inc. is registered to I.S. EN ISO 9001



H003

# Contents

Manual Conventions .....	2	Flushing .....	11
Warning .....	3	Repair .....	12
System Requirements .....	4	Parts .....	16
Grounding .....	5	Technical Data .....	19
Gun Trigger Safety .....	5	Dimensions .....	19
Pressure Relief Procedure .....	6	Graco Standard Warranty .....	20
Operating Gun .....	7	Graco Phone Numbers .....	20
Maintenance .....	9		

# Manual Conventions

## Warning

**WARNING**

A warning alerts you to possible serious injury or death if you do not follow instructions.

Symbols, such as fire and explosion (shown), alert you to a specific hazard and direct you to read the indicated hazard warnings on pages 3-4.

## Caution

**CAUTION**

A caution alerts you to possible equipment damage or destruction if you do not follow instructions.

## Note

A note indicates additional helpful information.

**WARNING**
**INJECTION HAZARD**

High-pressure fluid from gun, hose leaks, or ruptured components will pierce skin. This may look like just a cut, but it is a serious injury that can result in amputation. **Get immediate medical attention.**

- Do not point the gun at anyone or at any part of the body.
- Do not put your hand or fingers over the gun fluid nozzle.
- Do not stop or deflect leaks with your hand, body, glove, or rag.
- Do not “blow back” fluid; this is not an air spray system.
- Follow **Pressure Relief Procedure**, page 6, when you stop spraying and before cleaning, checking, or servicing equipment.
- Use lowest possible pressure when flushing, priming, or troubleshooting.
- Never spray without tip guard and trigger guard installed.
- Engage trigger lock when not spraying.
- Tighten all fluid connections before operating the equipment.
- Check hoses, tubes, and couplings daily. Replace worn or damaged parts immediately. High pressure hose cannot be recoupled; replace the entire hose.

**FIRE AND EXPLOSION HAZARD**





Solvent and paint fumes in work area can ignite or explode. To help prevent fire and explosion:

- Use equipment only in well ventilated area.
- Eliminate all ignition sources, such as pilot lights, cigarettes and plastic drop cloths (potential static arc).
- Do not plug or unplug power cords or turn lights on or off when flammable fumes are present.
- Keep the work area free of debris, including solvent, rags, and gasoline.
- Ground equipment and conductive objects. See **Grounding**, page 5.
- Hold gun firmly to side of grounded pail when triggering into pail.
- Use only grounded hoses.
- If there is static sparking or you feel a shock, **stop operation immediately**. Do not use equipment until you identify and correct the problem.

**EQUIPMENT MISUSE HAZARD**

Misuse can cause serious injury or death.

- For professional use only.
- Use equipment only for its intended purpose. Call your Graco distributor for information.
- Read manuals, warnings, tags, and labels before operating equipment. Follow instructions.
- Check equipment daily. Repair or replace worn or damaged parts immediately.
- Do not alter or modify equipment. Use only Graco parts and accessories.
- Do not exceed the maximum working pressure or temperature rating of the lowest rated system component. See **Technical Data** in all equipment manuals.
- Use fluids and solvents that are compatible with equipment wetted parts. See **Technical Data** in all equipment manuals. Read fluid and solvent manufacturer’s warnings.
- Route hoses and cables away from traffic areas, sharp edges, moving parts, and hot surfaces.
- Do not use hoses to pull equipment.
- Comply with all applicable safety regulations.

 <b>WARNING</b>	
	<p><b>BURN HAZARD</b></p> <p>This equipment is used with heated fluid, which can cause equipment surfaces to become very hot. To avoid severe burns:</p> <ul style="list-style-type: none"> <li>• Do not touch hot fluid or equipment.</li> <li>• Allow equipment to cool completely before touching it.</li> <li>• Wear gloves if fluid temperature exceeds 110° F (43° C).</li> </ul>
	<p><b>TOXIC FLUID OR FUMES HAZARD</b></p> <p>Toxic fluids or fumes can cause serious injury or death if splashed in the eyes or on skin, inhaled, or swallowed.</p> <ul style="list-style-type: none"> <li>• Read Material Safety Data Sheet (MSDS) to know the specific hazards of the fluids you are using.</li> <li>• Store hazardous fluid in approved containers, and dispose of it according to applicable guidelines.</li> </ul>
	<p><b>PERSONAL PROTECTIVE EQUIPMENT</b></p> <p>You must wear proper protective equipment when operating, servicing, or when in the operating area of the equipment to help protect you from serious injury, including eye injury; inhalation of toxic fumes, and hearing loss. This equipment includes but is not limited to:</p> <ul style="list-style-type: none"> <li>• Protective eyewear</li> <li>• Gloves, clothing, and respirator as recommended by the fluid and solvent manufacturer</li> <li>• Hearing protection</li> </ul>
	<p><b>RECOIL HAZARD</b></p> <p>The gun can recoil when triggered at very high pressure. If unprepared, this could force your hand back or cause you to fall and injure yourself. Be sure you have firm footing and hold the gun securely.</p>

## System Requirements

- Install a bleed-type master air valve on a pneumatic pump air supply line to relieve air trapped between this valve and the pump after air regulator is shut off. Trapped air can cause the pump to cycle unexpectedly.
- Install a fluid drain valve between the pump and gun to relieve pressure in displacement pump, hose, and gun. Triggering gun to relieve pressure may not be sufficient. See **Pressure Relief Procedure**, page 6.

# Grounding

**WARNING**



Read warnings, page 3.

Check your local electrical code and pump/sprayer manual for detailed grounding instructions.

- **Spray gun:** ground through connection to a grounded fluid hose and pump/sprayer.
- **Fluid hose:** use only grounded hoses.
- **Fluid supply container:** follow local code.
- **Object being sprayed:** follow local code.

- **Solvent flushing pails:** follow local code. Use only conductive metal pails placed on a grounded surface. Do not place pail on a nonconductive surface, such as paper or cardboard, which interrupts grounding continuity.



- **To maintain grounding continuity when flushing or relieving pressure:** hold metal part of gun firmly to side of grounded metal pail, then trigger gun.



# Gun Trigger Safety

**WARNING**



Read warnings, page 3.



Wallet-sized warning card with important injection treatment information is included with the gun. Additional cards are available at no charge. Provide a card to all operators.

- **To engage trigger lock:** turn it to position A. If engaged, gun will not trigger. Engage trigger lock whenever you stop spraying to avoid accidental triggering.

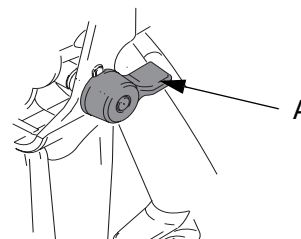

Ti1950A

- **To disengage trigger lock:** turn it to position B.

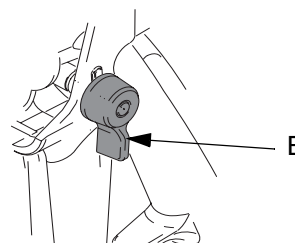

Ti1949A

# Pressure Relief Procedure

**⚠ WARNING**



Read warnings, page 3.

1. Engage trigger lock.

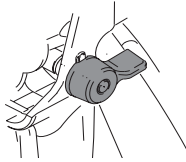

2. Shut off pump. Close bleed-type master air valve (pneumatic pumps only).

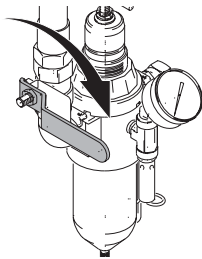

3. Disengage trigger lock.

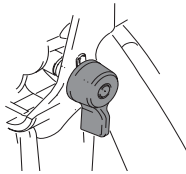

4. Hold a metal part of the gun firmly to a grounded metal pail. Trigger gun to relieve pressure.

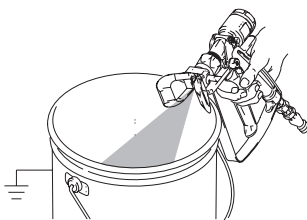

5. Engage trigger lock.

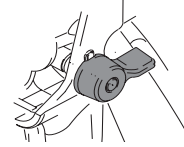

6. Open fluid drain valve; have a container ready to catch drainage. Leave drain valve open until you start spraying again.

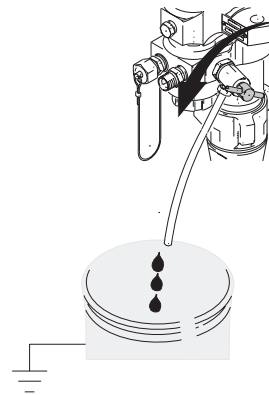

7. If you suspect that pressure is not fully relieved because:

- *Spray tip is clogged*

**SwitchTip:** Follow procedure on page 10.

**Flat Tip:** Very slowly loosen tip guard retaining nut and relieve pressure gradually then loosen completely. Clear tip.

- *Hose is clogged*

Slowly loosen hose end coupling and relieve pressure gradually. Clean hose obstruction.

T12178A

# Operating Gun

 Strain the fluid if it contains particles that could clog fluid tip.

1. Connect a grounded fluid hose to the gun.

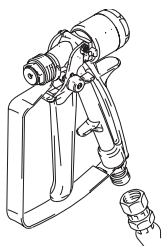

2. Without spray tip installed, flush pump as instructed in pump manual. Use lowest pressure possible. Be sure you have a firm footing and hold gun securely.

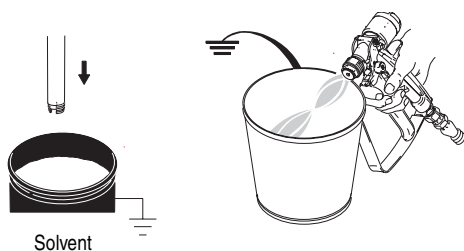

3. Prime system with material.

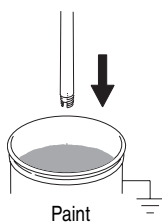

4. Follow **Pressure Relief Procedure**, page 6. Engage trigger lock.

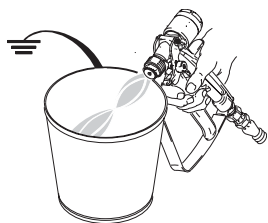

5. Install GHD RAC spray tip and tip guard as instructed in the enclosed GHD RAC tip instructions. See **Adjusting Spray Pattern**, page 8, for information on positioning for a vertical or horizontal pattern.

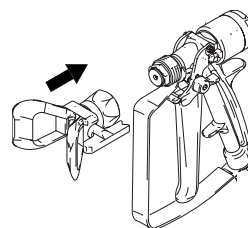

6. Start pump and spray onto test paper.
  - a. Adjust fluid pressure until spray is completely atomized. Use lowest pressure possible; higher pressure may not improve spray pattern and causes premature tip and pump wear.
  - b. If adjusting pressure does not give a good spray pattern, follow **Pressure Relief Procedure**, page 6, then try another tip size.

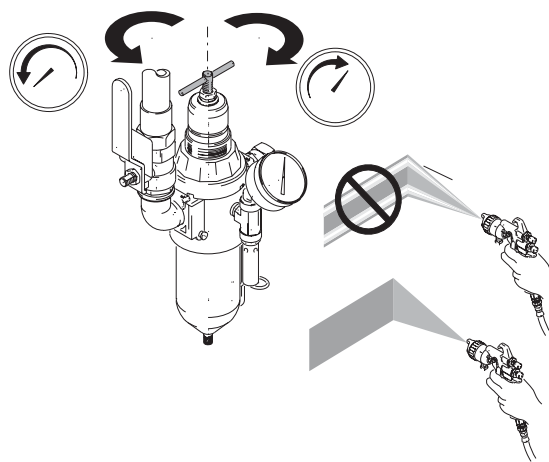

7. Trigger gun full-open or full-close. Hold gun at right angles to work surface. Do not swing gun in an arc. Practice to find the best length and speed of stroke.

# Adjusting Spray Pattern

## Spray Pattern Size

The spray tip orifice and spray angle determine pattern coverage and size. When you need more coverage, use a larger spray tip rather than increasing fluid pressure.

## Spray Pattern Direction

1. Follow **Pressure Relief Procedure**, page 6. Engage trigger lock.

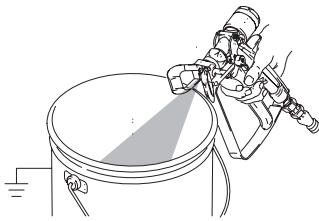

2. Loosen tip guard retaining nut (C).

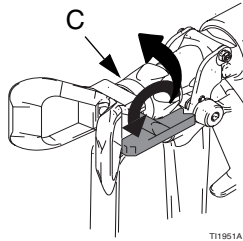

3. For a vertical pattern, turn tip guard to position E. For a horizontal pattern turn to position D.

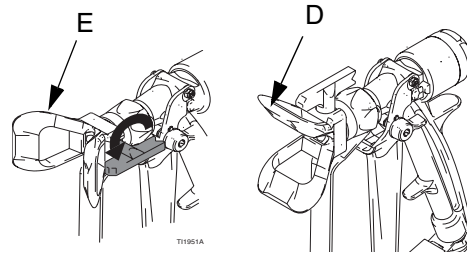

4. Tighten nut (C).

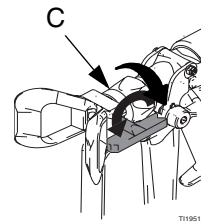



# Maintenance

## Cleaning Spray Tip and Tip Guard

**WARNING**

Read warnings, page 3.

**CAUTION**

- To avoid ruining packings, do not soak entire gun in solvent.
- Never hang gun by the tip guard. Damaging tip guard edges causes paint to collect there.

1. Follow **Pressure Relief Procedure**, page 6. Engage trigger lock.

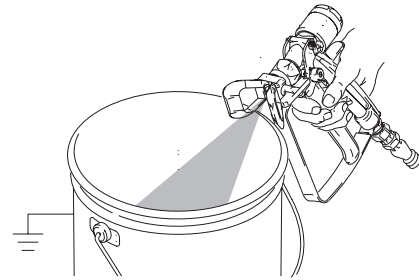

2. Clean spray tip with a solvent-soaked brush.
  - Clean front of tip frequently to reduce fluid buildup.
  - Clean tip and tip guard at end of each work day.

## If RAC Spray Tip Clogs

### WARNING



Read warnings, page 3.

**1.** If spray tip clogs while spraying, stop spraying immediately.

**2.** Engage trigger lock.



**3.** Rotate RAC tip handle back 180° (arrow points back).

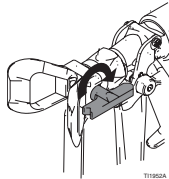

**4.** Disengage trigger lock.

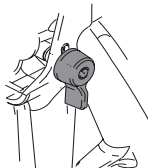

**5.** To remove clog, trigger gun into a pail or onto the ground.

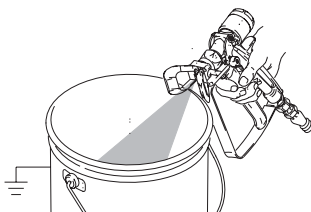

**6.** Engage trigger lock.

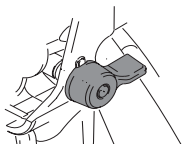

**7.** Rotate RAC tip handle (G) to spraying position (arrow points forward).

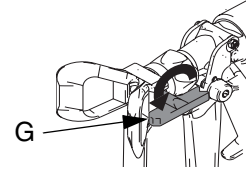

**8.** If tip is still clogged:

**a.** Engage trigger lock.

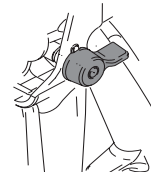

**b.** Shut off sprayer and disconnect power source.

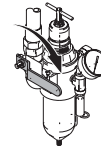

**c.** Open fluid drain valve to relieve pressure.



**d.** Remove and clean GHD RAC spray tip.

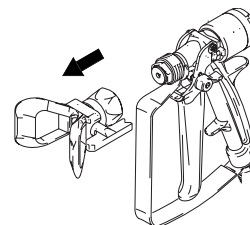

# Flushing

**⚠ WARNING**  
  
 Read warnings, page 3.

Flush pump and gun before fluid can dry in it. If available, use flushing procedure provided in your pump or sprayer manual instead of this procedure.

1. Follow **Pressure Relief Procedure**, page 6. Engage trigger lock.

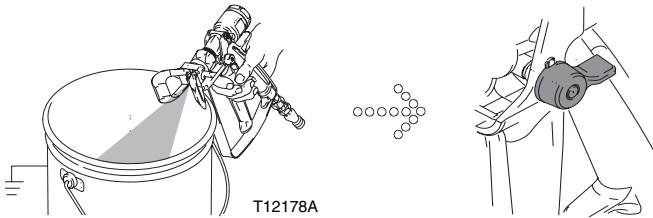

2. Remove tip guard and spray tip. Clean with solvent. See page 9.

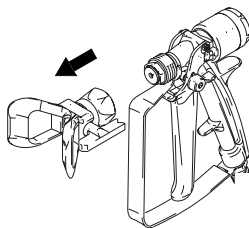

3. Put the pump intake in a grounded pail of compatible solvent.

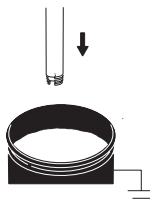

4. Start pump at its lowest pressure.

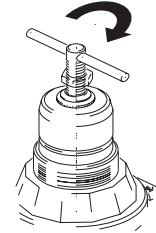

5. Disengage trigger lock, then trigger gun into the paint pail. When solvent appears, release trigger.

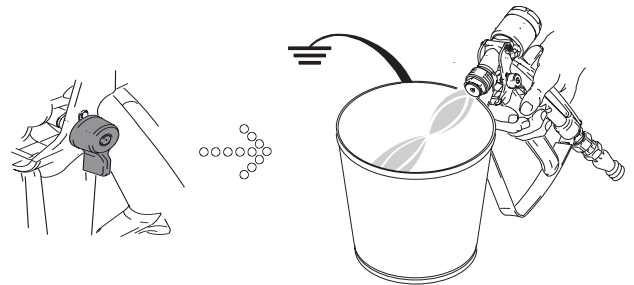

6. Trigger gun into solvent pail. Circulate fluid until system is thoroughly flushed.

7. Follow **Pressure Relief Procedure**, page 6. Engage trigger lock.

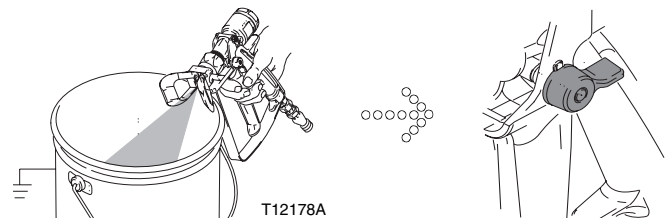

# Repair

 Repair Kit 245876 is available. Parts included with the kit are marked with \*.

## Disassembly

1. Follow **Pressure Relief Procedure**, page 6. Engage trigger lock.
2. Disconnect fluid hose. Remove tip and tip guard (17).

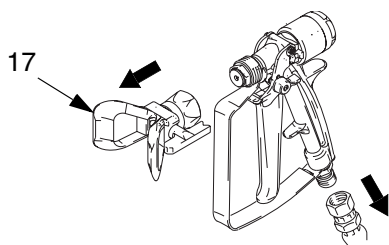

3. Using a wrench, remove cap (10) with spring (9) (releases spring tension on needle).

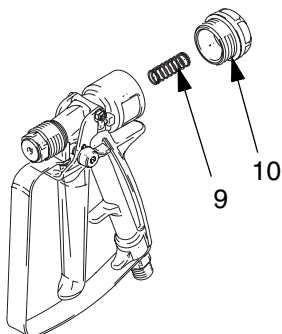

T12180A

4. Remove valve seat (2\*) and gasket (12\*).

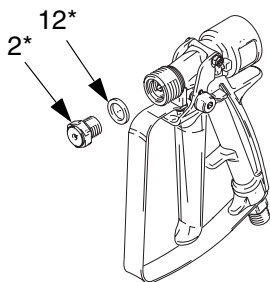

T12181A

5. Holding needle with tool (A\*), remove needle retainer (8).

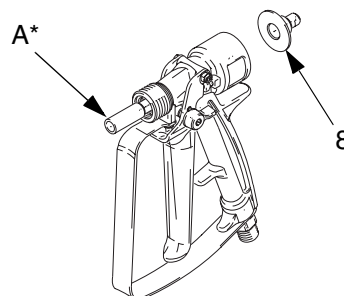

T12188A

6. Pull needle (3\*) out the front of the gun.

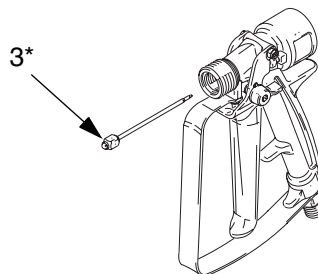

T12183A

7. Using a socket wrench, remove seal retainer (4\*) from the back of the gun. Use a pick to remove gasket (11\*).

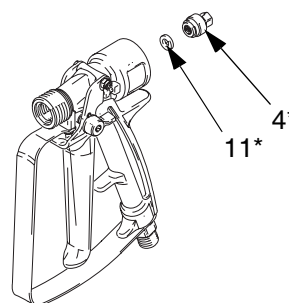

T12186A

8. Clean and replace parts as needed.

## If you need to remove trigger

1. Using a wrench, remove lock nut (13) from trigger stud (14).

 To avoid losing parts, be ready for two actuator pins (6) to fall out of gun body (1) when trigger (5) is removed.

2. Slide trigger stud (14) out of gun body, and remove trigger (5).
3. Install trigger in reverse order of disassembly. Grease actuator pins (6) and trigger stud (14).

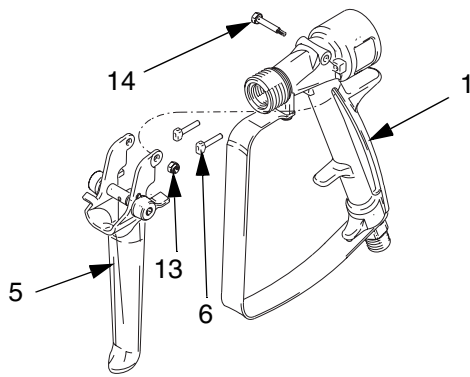

T12186A

## Assembly

 Use clean, petroleum jelly where grease is indicated.

1. Press a new gasket (11\*) into gun body. Lightly grease seal retainer (4\*) and install. **Torque to 48-72 in-lbs (5-8 N•m).**

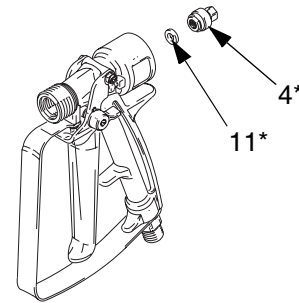

T12186A

2. Lightly grease needle (3\*), and install it into the front of the gun, pressing needle through seal retainer.

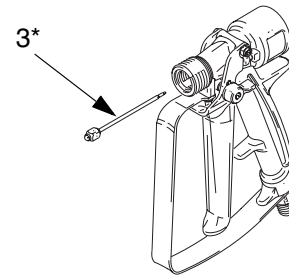

T12187B

3. Apply light-strength Loctite™ to needle threads. Holding needle with tool (A\*), install needle retainer (8). **Tighten until it bottoms out.**

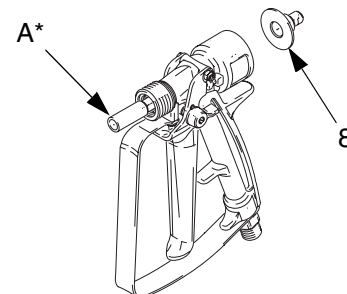

T12188A

- continued -

4. Lightly grease valve seat (2\*) threads. **Squeeze trigger to retract needle and** install gasket (12\*) and valve seat (2\*). Torque valve seat to 26-32 ft-lbs (35-43 N•m).

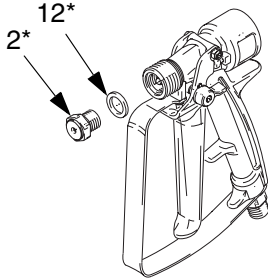

T12181A

5. Grease and install spring (9) and cap (10). Tighten cap to 10-13 ft-lbs (8-10 N•m).

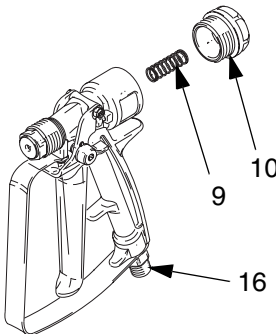

T12180A

 If fluid inlet fitting (16) is removed, to reinstall, apply sealant to threads and torque to 26-32 ft-lbs (35-43 N•m).

## Test gun before using

1. Engage trigger lock. Connect fluid hose to gun.

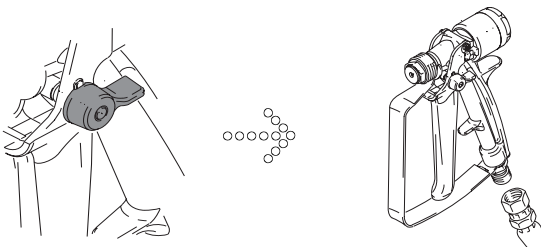

2. Start and prime the pump.

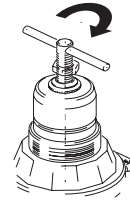

3. Disengage trigger lock and trigger gun into a waste container for a short time.

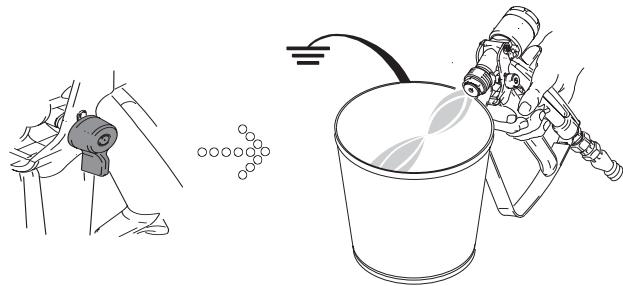

4. Release trigger; the gun should immediately stop spraying and there should not be any leaks.

If there is a problem, follow **Pressure Relief Procedure** on page 6, engage trigger lock, and disconnect fluid hose.

Check through **Assembly** procedure and correct problem.

5. Install tip and tip guard before regular use.

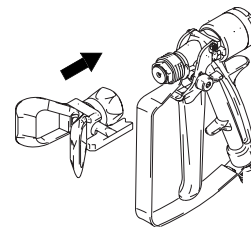



A series of horizontal lines for writing, starting from the top left and extending across the page.

# Parts

## Part No. 233889, Series A

Heavy Duty RAC tip guard, 519 SwitchTip™

## Part No. 234032, Series A

Standard (nonreversing) Dripless™ tip guard, 519 flat tip

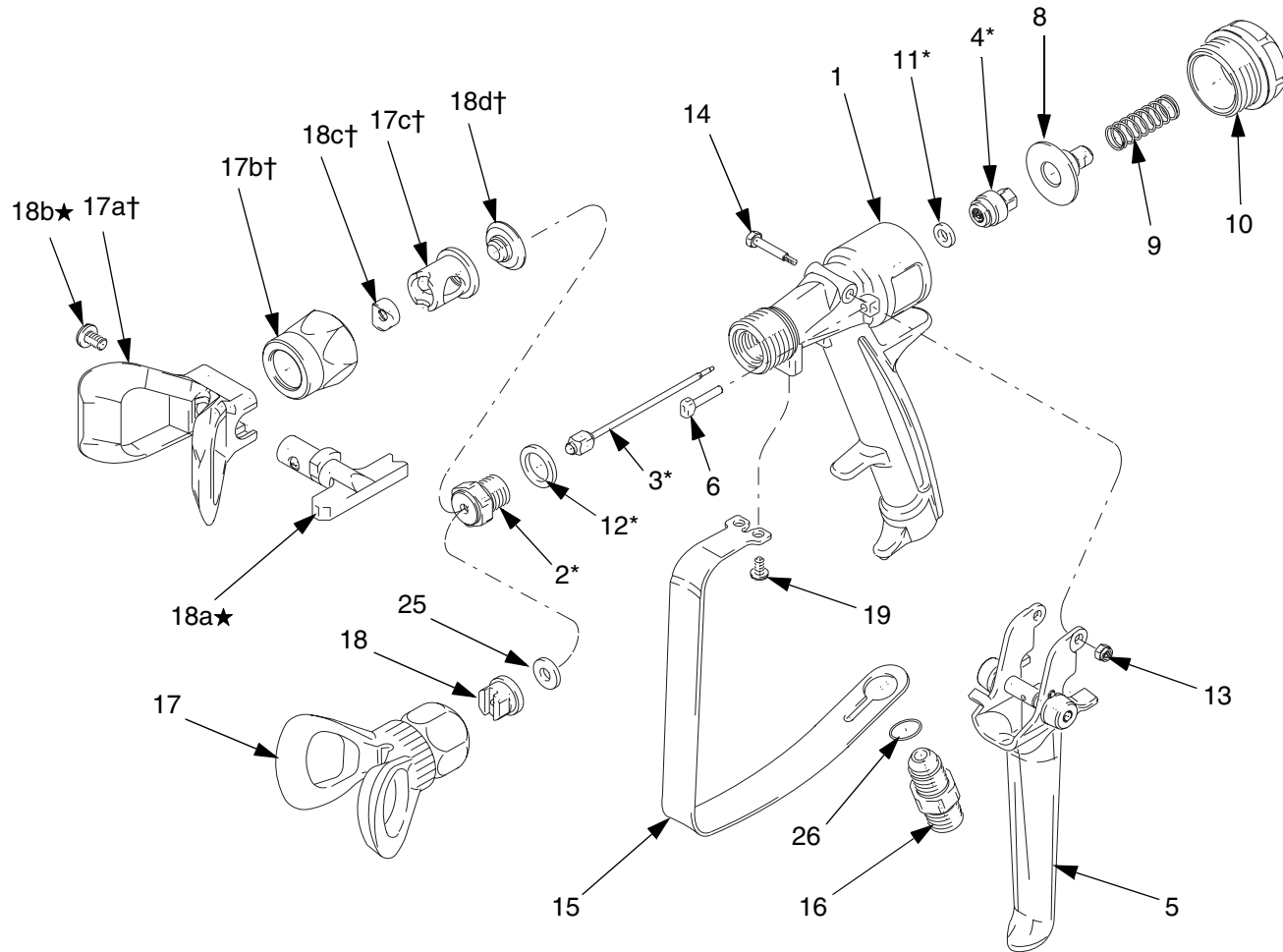

T12174B



**Part No. 233889, Series A**

Heavy Duty RAC tip guard, 519 SwitchTip™

Ref. No.	Part No.	Description	Qty.	Ref. No.	Part No.	Description	Qty.
1	15A858	GUN BODY	1	17c†	–	• HOUSING	1
2*	–	VALVE SEAT	1	18	GHD519	SwitchTip, 519 size; Includes items 18a-18d	1
3*	–	NEEDLE	1	18a★	–	• SwitchTip	1
4*	–	SEAL RETAINER ASSEMBLY	1	18b★	–	• SCREW	1
5	245857	TRIGGER	1	18c†	–	• SEAL	1
6	15A863	PIN	2	18d†	–	• GASKET	1
8	15A865	RETAINER	1	19	15B650	SCREWS, 6-32 UNC-2A	2
9	117350	SPRING	1	22▲	222385	WARNING CARD	1
10	15A864	CAP	1	23▲	187346	WARNING TAG	1
11*	–	GASKET	1	26	15B875	SEAL	1
12*	156766	GASKET	1				
13	105334	LOCKNUT; M4 x 0.7	1				
14	177538	STUD	1				
15	15A861	TRIGGER GUARD	1				
16	15A862	FLUID FITTING, 1/4 npsm x 1/2 UNEF	1				
17	245994	GHD RAC TIP GUARD; Includes items 17a-17c	1				
17a†	–	• TIP GUARD	1				
17b†	–	• NUT	1				

\* Parts included in Repair Kit 245876, purchased separately. Installation tool included.

† Parts not available separately. Order kit 245994 (see kit instructions 406554).

★ Parts not available separately.

▲ Replacement Danger and Warning labels, tags, and cards are available at no cost.

**Part No. 234032, Series A**

Standard (nonreversing) Dripless™ tip guard, 519 flat tip

Ref. No.	Part No.	Description	Qty.	Ref. No.	Part No.	Description	Qty.
1	15A858	GUN BODY	1	15	15A861	TRIGGER GUARD	1
2*	–	VALVE SEAT	1	16	15A862	FLUID FITTING, 1/4 npsm x 1/2 UNEF	1
3*	–	NEEDLE	1	17	220222	TIP GUARD	1
4*	–	SEAL RETAINER ASSEMBLY	1	18	163519	SPRAY TIP, 519 size	1
5	246298	TRIGGER	1	19	15B650	SCREWS, 6-32 UNC-2A	2
6	15A863	PIN	2	22▲	222385	WARNING CARD	1
8	15A865	RETAINER	1	23▲	187346	WARNING TAG	1
9	117350	SPRING	1	25	166969	TIP GASKET	1
10	15A864	CAP	1	26	15B875	SEAL	1
11*	–	GASKET	1				
12*	156766	GASKET	1				
13	105334	LOCKNUT; M4 x 0.7	1				
14	177538	STUD	1				

\* Parts included in Repair Kit 245876, purchased separately. Installation tool included.

▲ Replacement Danger and Warning labels, tags, and cards are available at no cost.

## Accessories

**Part No. 245878: 2-Finger Trigger Kit**

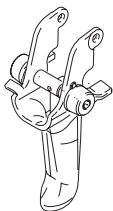

**Front Extension:** 7/8-14 UNF-2B with RAC 5 tip guard and tip

**Part No. 246294:** 10" (0.25 m)

**Part No. 246295:** 15" (0.4 m)

**Part No. 246296:** 18" (0.5 m)

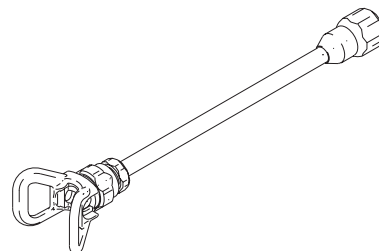

**Part No. 236987: Inlet Swivel**

1/4 npsm



**Part No. 246297: 180° Spray Nozzle**

7/8-14 UNC-2B

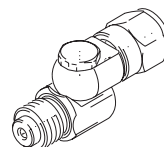

**Part No. 246291: Gun Filter Swivel**

1/4 npsm (not shown)

**Part No. 194744: Packing Repair Tool**

Included in Repair Kit 245876

24 194744 TOOL, packing repair

1

# Technical Data

Maximum Working Pressure . . . . .	7250 psi (50 MPa, 500 bar)
Fluid Orifice . . . . .	0.090" (2.3 mm)
Fluid Inlet . . . . .	1/4 npsm(m)
Fluid Tube Inside Diameter . . . . .	0.25" (6.4 mm)
Maximum Fluid Temperature . . . . .	160°F (71°C)
Sound Pressure . . . . .	103 dB(A)*
Sound Power . . . . .	111.6 dB(A)*
Wetted Parts . . . . .	stainless steel, polyethylene, nylon, polypropylene, acetal, carbide, plated steel

\*Results are maximum readings taken at 6000 psi (41 MPa, 414 bar), with HD427 tip, using water. Sound power level was tested to ISO 3744-1981.

# Dimensions

Weight (including tip and tip guard) . . . . .	26 oz (745 g)
Length . . . . .	5" (127 mm)
Height . . . . .	8" (203 mm)

# Graco Standard Warranty

Graco warrants all equipment referenced in this document which is manufactured by Graco and bearing its name to be free from defects in material and workmanship on the date of sale by an authorized Graco distributor. With the exception of any special, extended, or limited warranty published by Graco, Graco will, for a period of twelve months from the date of sale, repair or replace any part of the equipment determined by Graco to be defective. This warranty applies only when the equipment is installed, operated and maintained in accordance with Graco's written recommendations.

This warranty does not cover, and Graco shall not be liable for general wear and tear, or any malfunction, damage or wear caused by faulty installation, misapplication, abrasion, corrosion, inadequate or improper maintenance, negligence, accident, tampering, or substitution of non-Graco component parts. Nor shall Graco be liable for malfunction, damage or wear caused by the incompatibility of Graco equipment with structures, accessories, equipment or materials not supplied by Graco, or the improper design, manufacture, installation, operation or maintenance of structures, accessories, equipment or materials not supplied by Graco.

This warranty is conditioned upon the prepaid return of the equipment claimed to be defective to an authorized Graco distributor for verification of the claimed defect. If the claimed defect is verified, Graco will repair or replace free of charge any defective parts. The equipment will be returned to the original purchaser transportation prepaid. If inspection of the equipment does not disclose any defect in material or workmanship, repairs will be made at a reasonable charge, which charges may include the costs of parts, labor, and transportation.

**THIS WARRANTY IS EXCLUSIVE, AND IS IN LIEU OF ANY OTHER WARRANTIES, EXPRESS OR IMPLIED, INCLUDING BUT NOT LIMITED TO WARRANTY OF MERCHANTABILITY OR WARRANTY OF FITNESS FOR A PARTICULAR PURPOSE.**

Graco's sole obligation and buyer's sole remedy for any breach of warranty shall be as set forth above. The buyer agrees that no other remedy (including, but not limited to, incidental or consequential damages for lost profits, lost sales, injury to person or property, or any other incidental or consequential loss) shall be available. Any action for breach of warranty must be brought within two (2) years of the date of sale.

**GRACO MAKES NO WARRANTY, AND DISCLAIMS ALL IMPLIED WARRANTIES OF MERCHANTABILITY AND FITNESS FOR A PARTICULAR PURPOSE, IN CONNECTION WITH ACCESSORIES, EQUIPMENT, MATERIALS OR COMPONENTS SOLD BUT NOT MANUFACTURED BY GRACO.** These items sold, but not manufactured by Graco (such as electric motors, switches, hose, etc.), are subject to the warranty, if any, of their manufacturer. Graco will provide purchaser with reasonable assistance in making any claim for breach of these warranties.

In no event will Graco be liable for indirect, incidental, special or consequential damages resulting from Graco supplying equipment hereunder, or the furnishing, performance, or use of any products or other goods sold hereto, whether due to a breach of contract, breach of warranty, the negligence of Graco, or otherwise.

## **FOR GRACO CANADA CUSTOMERS**

The Parties acknowledge that they have required that the present document, as well as all documents, notices and legal proceedings entered into, given or instituted pursuant hereto or relating directly or indirectly hereto, be drawn up in English. Les parties reconnaissent avoir convenu que la rédaction du présente document sera en Anglais, ainsi que tous documents, avis et procédures judiciaires exécutés, donnés ou intentés, à la suite de ou en rapport, directement ou indirectement, avec les procédures concernées.

# Graco Phone Numbers

**TO PLACE AN ORDER**, contact your Graco distributor or call to identify the nearest distributor.

**Phone:** 612-623-6921 **or Toll Free:** 1-800-367-4023, **Fax:** 612-378-3505

*All written and visual data contained in this document reflects the latest product information available at the time of publication.  
Graco reserves the right to make changes at any time without notice.*

**Sales Offices:** Minneapolis, Detroit  
**International Offices:** Belgium, Korea, Hong Kong, Japan  
**GRACO INC. P.O. BOX 1441 MINNEAPOLIS, MN 55440-1441**  
www.graco.com  
Printed in USA 309523D

## Free Manuals Download Website

<http://myh66.com>

<http://usermanuals.us>

<http://www.somanuals.com>

<http://www.4manuals.cc>

<http://www.manual-lib.com>

<http://www.404manual.com>

<http://www.luxmanual.com>

<http://aubethermostatmanual.com>

Golf course search by state

<http://golfingnear.com>

Email search by domain

<http://emailbydomain.com>

Auto manuals search

<http://auto.somanuals.com>

TV manuals search

<http://tv.somanuals.com>