

iHome®

Model iH110
Alarm Clock FM Radio
for your iPod®

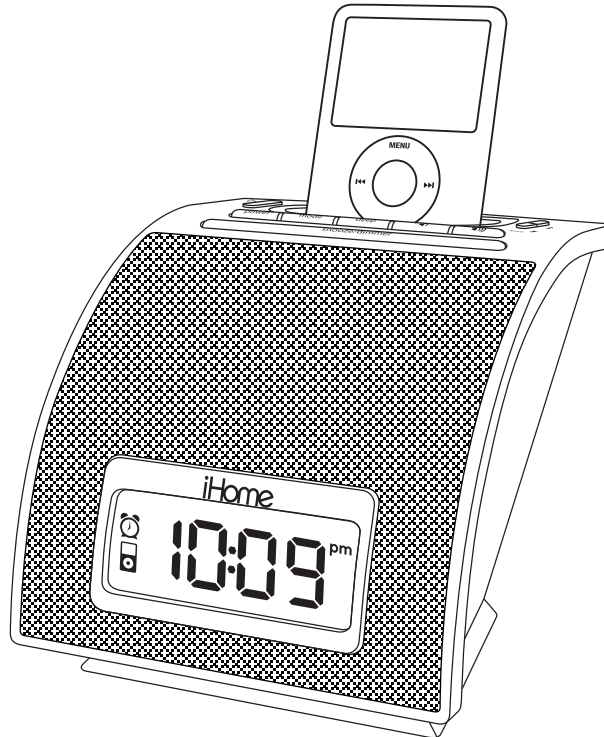

Questions? Visit www.ihomeaudio.com

Download from www.Somaterials.com. All Manuals Search And Download.

Table of Contents

Quick Start	1
Controls and Indicators	2
iH110 Display	3
Install Clock Backup Battery	3
Setting Up the iH110	4
Charging your iPod	4
Listening to your iPod	5
Listening to FM Radio	5
Listening to non-docking iPod or other portable audio device	5
Alarm Operation	6
Sleep Operation	7
Snooze/Dimmer Operation	7
A Consumer Guide to Product Safety	8
Trouble Shooting	9
Solución De Problemas	10
Warranty Information	11

FCC Information

This device complies with Part 15 of the FCC Rules, operation is subject to the following two conditions: (1) This device may not cause harmful interference, and (2) this device must accept any interference received, including interference that may cause undesired operation.

This equipment complies with the limits for a Class B digital device as specified in Part 15 of FCC Rules. These limits provide reasonable protection against radio and TV interference in a residential area.

However, your equipment might cause TV or radio interference even when it is operating properly. To eliminate interference you can try one or more of the following corrective measures:

- Reorient or relocate the receiving antenna.
- Increase the distance between the equipment and the radio or TV.
- Use outlets on different electrical circuits for the equipment and the radio or TV.

Consult your dealer or an experienced radio/television technician if the problem still exists.

Modifying or tampering with your system's internal components can cause a malfunction and might invalidate the system's warranty and void your FCC authorization to operate it.

This Class B digital apparatus complies with Canadian ICES-003.

Maintenance

- Place the unit on a level surface away from sources of direct sunlight or excessive heat.
- Protect your furniture when placing your unit on a natural wood and lacquered finish. A cloth or other protective material should be placed between it and the furniture.
- Clean your unit with a soft cloth moistened only with mild soap and water. Stronger cleaning agents, such as Benzine, thinner or similar materials can damage the surface of the unit.

Quick Start

1:power

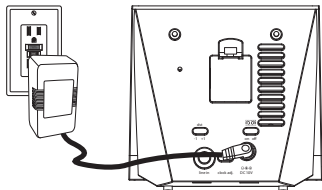

Attach AC adaptor cable to jack on back of the iH110 and plug the other end into a wall socket.

2:inserts

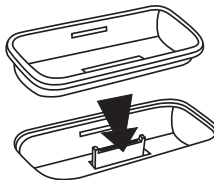

Select the dock insert for your iPod model from the table below and place insert in dock.
Never dock an iPod without an insert in place.

3:iPod

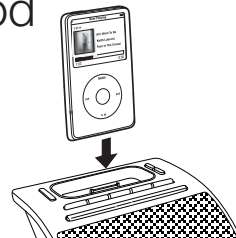

Insert iPod into dock with proper insert (iPod must not be in a skin or case). iPod will charge while docked. Press iPod Button on iH110 to play iPod.

Use this insert

iPod Touch
insert 14

3rd Gen nano
insert 13

thin iPod with video (30 GB)
Insert 9

iPod with video (60,80 GB)
Insert 10

For this iPod

iPod Touch

3rd Gen nano

thin (30 GB) iPod with video
thin (80GB) iPod classic

thick (60, 80 GB) iPod with video
thick (160 GB) iPod classic

NOTE: If the insert for your iPod isn't listed, please visit an Apple store or www.ihomeaudio.com to purchase the proper insert.

4:time



- Move the DST switch on the back of the unit to +1 or -1 (adds or subtracts an hour to account for daylight saving time).
- Press & Hold the Clock adj. button on the back of the unit until the display flashes.
- Press the UP or DOWN buttons to set current time.
- Press the Clock Adj. button again to confirm time setting.

Controls and Indicators

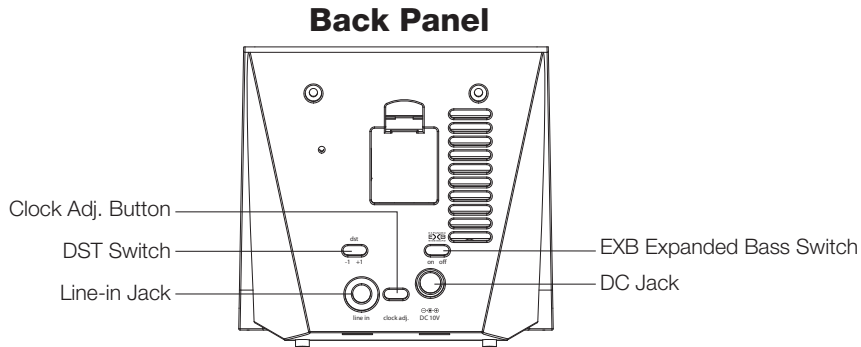
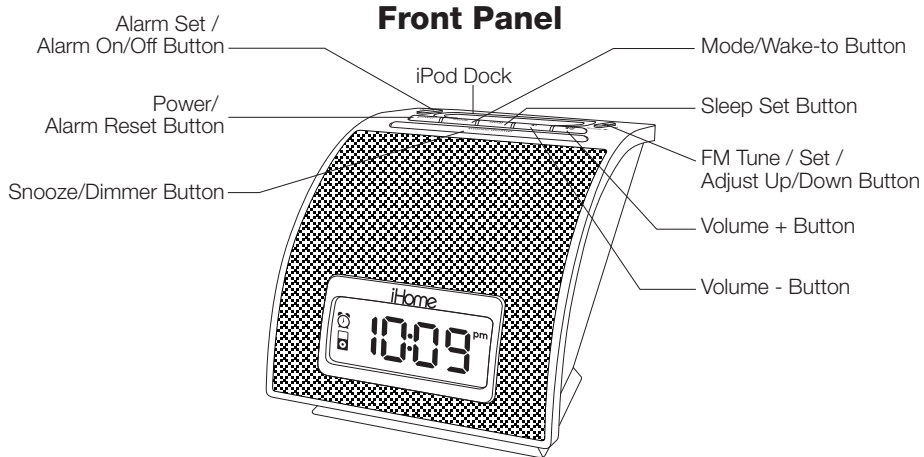

iH110 Display

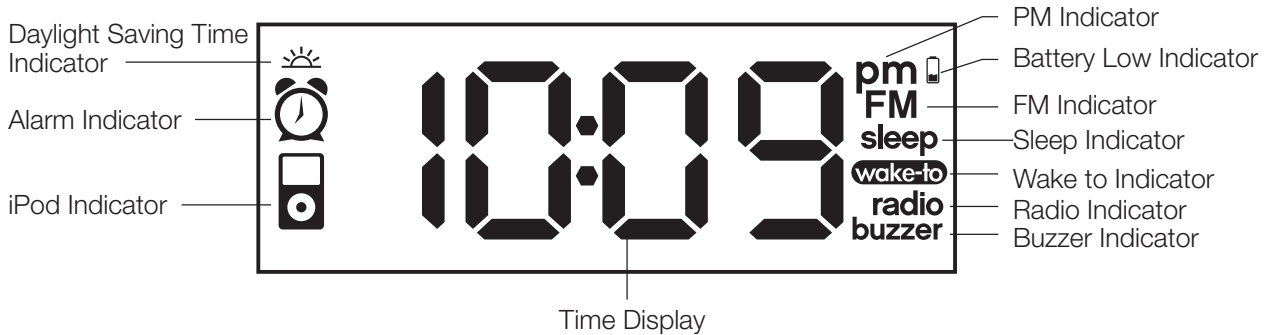

Install Clock Backup Battery

The iH110 uses a CR2032 button cell backup battery system to provide continuous alarm operation and clock settings in the event of a power failure. If the Backup Battery has been installed and a power failure occurs or the AC adaptor is accidentally disconnected, the display backlight will not remain lit, but current time and alarm time settings will be temporarily maintained. Otherwise, you must reset the time and alarm settings.

1. Please make sure the AC adaptor is connected. Otherwise all settings may be lost during battery replacement.
2. Open backup battery compartment door located on the backside of the unit.
3. Insert one CR2032 button cell battery, checking that the polarity (+ and - sides of the battery) matches the drawing in the battery compartment. Close the compartment door.

Note: Make sure you dispose of batteries properly (see your local regulations).

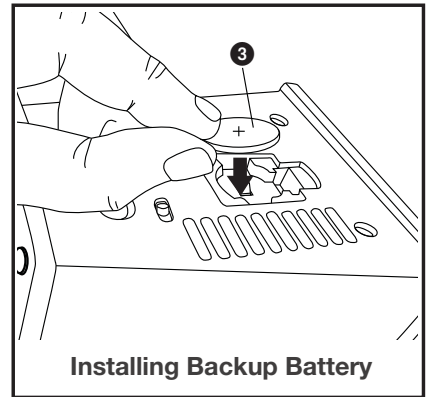

Setting Up the iH110

Setting the Clock Time

Note: Press the **Clock Adj. Button** once during normal operation to view the current time display format (12 hour or 24 hour format). 12 hour is the default format.

1. Press and hold the **Clock Adj. Button** for 2 seconds until the display flashes. Press the **UP** or **DOWN Button** until the current time is displayed.
2. For 12 hour or 24 hour time format setting: Press the **Alarm Set Button** during time setting to set 12-hour or 24-hour display format. Remember to set the correct AM or PM time (an icon to the right of the time display is the PM indicator; there is no AM indicator). Note that the PM indicator will not appear when using 24 hour display mode.
3. Press the **Clock Adj. Button** again to confirm the clock setting. You should hear 2 beeps indicating the clock time is set.
4. During daylight saving time, set the **DST Switch** located on the back of the unit to +1 to advance the time one hour. The DST Icon will appear on the display to indicate DST is on. Set the switch to -1 to set the time back one hour at the end of daylight saving time.

Charging your iPod



Note: Please make sure you are using the correct insert for your iPod (see page 1) and that it is properly docked into the iH110. Failure to do so may damage your iPod.

1. While your iPod is docked in the unit and the unit is connected to AC power, it recharges (until fully charged). The iH110 will not overcharge your iPod. Note that other non-docking iPods will NOT charge.

Listening to your iPod

1. Dock the already playing iPod. The iH110 will automatically turn on and you will hear the music playing from your iPod. The  will appear at the left lower corner the display, indicating iPod playing mode. For enhanced bass, slide the **EXB Expanded Bass Switch** located on the back of the unit to the ON position.

Note: If the playing song/music loudness is too low on the iPod, the iH110 may not detect that the iPod is in play mode. Press the  on the iPod to play it.

2. Press the  and  Buttons to adjust the system volume.
3. Press the **UP** or **DOWN Button** to go to the next or previous track. Press and hold while a track is playing for high speed forward or reverse music search of the current track.
4. To turn the iH110 OFF, press the **Power Button**. Your iPod will continue charging while in the dock.



Listening to FM Radio

For best reception, extend the FM antenna away from unit and adjust as needed. Do not alter antenna.

1. Press the **Power Button** to turn on the unit. Press the **Mode Button** until the radio icon appears.
2. Press the **UP** or **DOWN Button** to tune in the desired FM station. Press and hold to seek the next clear FM station.
3. Press the  and  Buttons to adjust the volume.
4. To turn the iH110 OFF, press the **Power Button**.

Listening to a non-docking iPod or other portable audio device

You can play an iPod without a docking port or other MP3 player or portable audio device through the iH110 via the **Line-in Jack**.

1. Plug one end of an audio patch cord (**available at www.ihomeaudio.com**) into the headphone or line-out jack on your device and the other end of the patch cord into the iH110 **Line-in Jack**, located on the back of the unit.
2. Press the **Power Button** to turn the iH110 on. Press the **Mode Button** until the  icon appears at the lower left corner the display, indicating Line-in playing mode.
3. Turn on and play your device.
4. Press the  and  Buttons to adjust the system volume. You may need to adjust your device volume, too.
5. To turn othe iH110 OFF, press the **Power Button**. Please remember to turn off your device, too.

Alarm Operation

The iH110 Home System for iPod features “Sure Alarm”. If a power failure occurs or the AC adaptor is accidentally disconnected, the unit will change to buzzer alarm to wake you up (provided you have installed backup battery).

This unit also features Gentle Waking, which gradually increases the volume of whatever alarm you set.

NOTE: TO WAKE TO iPod, YOUR iPod MUST BE PROPERLY DOCKED AND OFF (NOT IN PLAY MODE) OR NO ALARM WILL SOUND. You CANNOT wake to Line in audio devices.

Setting the Alarm

1. Press and hold the **Alarm Set Button** until the display flashes. Press the **UP or DOWN Button** until the desired alarm time is displayed. Remember to set the correct AM or PM time, indicated by PM on the display; there is no AM indicator.
2. Press the **Mode Button** as needed to select radio, buzzer or iPod as your wake to source. The icon for the selected wake source will flash.
3. Press the **Alarm Set Button** again to exit the setting mode. You should hear 2 beeps indicating the alarm is set.

Note: Once you set the alarm time, the alarm will be automatically armed, indicated by the  icon. To disarm the alarm, press the **Alarm Set Button**. The Alarm Icon will disappear and the alarm will not sound at the set time.

Note: Make sure to adjust volume level for a comfortable wake up volume.

4. When the alarm is sounding, the **Alarm Icon** will flash.
 - To snooze during the alarm, press the **Snooze/Dimmer Button**. The alarm will be silenced for 9 minutes, then come on again.
 - To turn the alarm off, press the **Alarm Reset/Power Button**. The alarm will come on again the next day at the same time.
5. If the alarm is not turned off after it sounds, it will play for approximately one hour then turn off automatically. This cycle will repeat every 24 hours unless the controls are changed.

Note: Please make sure your iPod has enough songs to play for one hour, otherwise please set the iPod repeat mode to ON.

Note: If there is no iPod present or there is no music detected on the iPod at alarm time, the iH110 will automatically switch to buzzer alarm.

Sleep Operation

1. When the iH110 is off or while listening to your iPod, press the **Sleep/Minute Set Button** to enter sleep mode. The **Sleep Icon** will appear on the display to indicate it is in sleep mode. Sleep mode has a Gentle Sleep feature which gradually lowers the volume before it shuts off.
2. You can adjust the sleep timer from 90, 60, 30 or 15 minutes by pressing the **Sleep/Minute Set Button** again. The unit will automatically turn off after the selected time.
3. When the display changes back to show the real time, pressing the **Sleep/Minute Set Button** once will show the sleep time remaining. Pressing it again will change the sleep time to the next lowest increment.
4. The iH110 has an independent volume setting for sleep mode so you can adjust the sleeping volume without affecting the alarm volume. Press the **◀** and **▶▶** **Buttons** to adjust the sleep volume. The sleep volume will remain at that level the next time you enter sleep mode until controls are changed.
5. To stop listening at any time, press the **Alarm Reset/Power Button** to turn unit off.

Snooze/Dimmer Operation

1. Press the **Snooze/Dimmer Button** after the alarm sounds. The alarm will go off and will come on again in about 9 minutes. You may repeat this cycle several times during the one hour alarm cycle.
2. During normal operation, press the **Snooze/Dimmer Button** to control the brightness (high, medium, low and off) of the LCD display and side accent lights.

IMPORTANT SAFETY INSTRUCTIONS

When used in the directed manner, this unit has been designed and manufactured to ensure your personal safety. However, improper use can result in potential electrical shock or fire hazards. Please read all safety and operating instructions carefully before installation and use, and keep these instructions handy for future reference. Take special note of all warnings listed in these instructions and on the unit.

1. **Water and Moisture** – The unit should not be used near water. For example: near a bathtub, washbowl, kitchen sink, laundry tub, swimming pool or in a wet basement.
2. **Ventilation** – The unit should be situated so that its location or position does not interfere with its proper ventilation. For example, it should not be situated on a bed, sofa, rug or similar surface that may block ventilation openings. Also, it should not be placed in a built-in installation, such as a bookcase or cabinet, which may impede the flow of air through the ventilation openings.
3. **Heat** – The unit should be situated away from heat sources such as radiators, heat registers, stoves or other appliances (including amplifiers) that produce heat.
4. **Power Sources** – The unit should be connected to a power supply only of the type described in the operating instructions or as marked on the appliance.
5. **Power-Cable Protection** – Power supply cables should be routed so that they are not likely to be walked on or pinched by items placed upon or against them. It is always best to have a clear area from where the cable exits the unit to where it is plugged into an AC socket.
6. **Cleaning** – The unit should be cleaned only as recommended. See the Maintenance section of this manual for cleaning instructions.
7. **Objects and Liquid Entry** – Care should be taken so that objects do not fall and liquids are not spilled into any openings or vents located on the product.
8. **Attachments** – Do not use attachments not recommended by the product manufacturer.
9. **Lightning and Power Surge Protection** – Unplug the unit from the wall socket and disconnect the antenna or cable system during a lightning storm or when it is left unattended and unused for long periods of time. This will prevent damage to the product due to lightning and power-line surges.
10. **Overloading** – Do not overload wall sockets, extension cords, or integral convenience receptacles as this can result in a risk of fire or electric shock.
11. **Damage Requiring Service** – The unit should be serviced by qualified service personnel when:
 - A. the power supply cable or plug has been damaged.
 - B. objects have fallen into or liquid has been spilled into the enclosure.
 - C. the unit has been exposed to rain.
 - D. the unit has been dropped or the enclosure damaged.
 - E. the unit exhibits a marked change in performance or does not operate normally.
12. **Periods of Nonuse** – If the unit is to be left unused for an extended period of time, such as a month or longer, the power cable should be unplugged from the unit to prevent damage or corrosion.
13. **Servicing** – The user should not attempt to service the unit beyond those methods described in the user's operating instructions. Service methods not covered in the operating instructions should be referred to qualified service personnel.

**Questions? Visit www.ihomeaudio.com
or call 1-800-288-2792 Toll Free**

Trouble Shooting

Symptom	Possible Problem	Solution
Unit doesn't respond (no power)	AC adaptor isn't plugged to a wall outlet or the connector is not plugged into the power supply jack on the back of the unit	Plug the AC adaptor into a wall outlet and plug the connector into the power supply jack on the unit
	Wall outlet is not functioning	Plug another device into the same outlet to confirm the outlet is working
iPod cannot dock properly	Using no or wrong iPod insert	Make sure the dock insert is the proper fit for your iPod
	iPod is not installed properly	Remove your iPod from the connector and check for any obstruction on the connectors in the dock and on your iPod. Then reseat it in the dock.
iPod does not respond to the unit	iPod is not installed properly	Remove your iPod from the connector and check for any obstruction on the connectors in the dock and on your iPod. Then reseat it in the dock.
	Your iPod software is too old	Upgrade software on your iPod. For details, visit http://www.apple.com or iTunes
	iPod is locked up	Please make sure your iPod is working properly before docking it to the unit. Please refer to your iPod manual for details on iPod operation.
	Using 1 st or 2 nd generation iPod or other device	iH110 cannot control those iPods or other devices.
iPod didn't charge up	iPod is not installed properly	Remove your iPod from the connector and check for any obstruction on the connectors in the dock and on your iPod. Then reseat it in the dock.
	iPod is locked up/frozen	Please make sure your iPod is working properly before docking it to the unit. Please refer to your iPod manual for details.
	iPod battery has problem	
Sound is distorted	Volume level is set too high	Decrease the volume. Turn off EXB bass effect
	Sound source is distorted	If iPod original sound source is poor quality, distortion and noise are easily noticed with high-power speakers. Try a different audio source such as a music CD.
		If you are using an iPod Shuffle or external sound source like older generation iPod, try reducing the output volume on the device itself. Also, try reducing bass.

Solución De Problemas

Síntoma	Posible Problema	Solución
La unidad no funciona (no circula corriente eléctrica)	El adaptador de AC no está conectado al tomacorriente o el conector no está conectado a la ficha en la parte posterior de la unidad	Conecte el adaptador de AC al tomacorriente y también conecte el conector a la ficha en la parte posterior de la unidad
	El tomacorriente no funciona	Coloque otro aparato en ese mismo tomacorriente para confirmar si el que no funciona es el tomacorriente
El iPod no encastra correctamente	No ha colocado el encastre del iPod, o está utilizando el encastre incorrecto.	Verifique que el encastre sea el apropiado para su iPod
	El iPod no encastra correctamente	Quite el iPod del encastre y retire la posible obstrucción del encastre o de su iPod. Vuelva a colocar el iPod dentro del encastre.
El iPod no se comunica con la unidad	El iPod no está instalado correctamente	Quite el iPod del encastre y verifique posibles obstrucciones del encastre o de su iPod. Vuelva a colocar el iPod dentro del encastre.
	Su software es obsoleto	Renueve su software. Para mayor información, diríjase a http://www.apple.com or iTunes
	El iPod no responde	Verifique que su iPod funcione correctamente antes de conectarlo a la unidad. Refiérase al manual de su iPod para más detalles.
	Usted tiene un iPod de primera o segunda generación, un Shuffle u otro tipo de aparato	El iH110 no puede controlar estos otros aparatos
El iPod no carga	El iPod no está instalado correctamente	Quite el iPod del encastre y retire la posible obstrucción del encastre o de su iPod. Vuelva a colocar el iPod dentro del encastre.
	El iPod está trabado/no responde	Por favor asegúrese de que su iPod funcione correctamente antes de colocarlo en el encastre. Refiérase al manual de su iPod para mayor información.
	La batería del iPod podría tener algún inconveniente	
El sonido sale distorsionado	El volumen se encuentra muy alto	Baje el volumen y no EXB
	El sonido sale distorsionado de la unidad	Si el sonido original de su iPod era de pobre calidad, las distorsiones y ruidos se harán más notables con los parlantes de alta potencia. Pruebe utilizar otra fuente de audio como un CD. Si está utilizando un iPod de primeras generaciones o un Shuffle, intente bajar el volumen de su aparato. También intente apagar el amplificador de bajos

Limited 90-Day Warranty Information

iHome Products, a division of SDI Technologies Inc. (hereafter referred to as SDI Technologies), warrants this product to be free from defects in workmanship and materials, under normal use and conditions, for a period of 90 days from the date of original purchase.

Should this product fail to function in a satisfactory manner, it is best to first return it to the store where it was originally purchased. Should this fail to resolve the matter and service still be required by reason of any defect or malfunction during the warranty period, SDI Technologies will repair or, at its discretion, replace this product without charge (except for a \$10.00 charge for handling, packing, return UPS/postage, and insurance). This decision is subject to verification of the defect or malfunction upon delivery of this product to the Factory Service Center listed below. The product must include proof of purchase, including date of purchase. The fee for service without proof of purchase is \$20.00.

Before returning this product for service, please first replace the batteries (if applicable) with fresh ones, as exhausted or defective batteries are the most common cause of problems encountered.

If service is still required:

1. Remove the batteries (if applicable) and pack the unit in a well padded, heavy corrugated box.
2. Enclose a photocopy of your sales receipt, credit card statement, or other proof of the date of purchase, if within the warranty period.
3. Enclose a check or money order payable to the order of SDI Technologies, for the sum of \$10.00 (\$20.00 without proof of purchase).
4. Send the unit prepaid and insured, to the Factory Service Center listed below.

Consumer Repair Department

*SDI Technologies Inc.
1330 Goodyear Drive
El Paso, TX 79936-6420*

Disclaimer of Warranty

NOTE: This warranty is valid only if the product is used for the purpose for which it was designed. It does not cover (i) products which have been damaged by negligence or willful actions, misuse or accident, or which have been modified or repaired by unauthorized persons; (ii) cracked or broken cabinets, or units damaged by excessive heat; (iii) damage to digital media players, CD's or tape cassettes (if applicable); (iv) the cost of shipping this product to the Factory Service Center and its return to the owner.

This warranty is valid only in the United States of America and does not extend to owners of the product other than to the original purchaser. In no event will SDI Technologies or any of its affiliates, contractors, resellers, their officers, directors, shareholders, members or agents be liable to you or any third party for any consequential or incidental damages, any lost profits, actual, exemplary or punitive damages. (Some states do not allow limitations on implied warranties or exclusion of consequential damages, so these restrictions may not apply to you.) This warranty gives you specific legal rights, and you may also have other rights which vary from state to state.

Your acknowledgement and agreement to fully and completely abide by the above mentioned disclaimer of warranty is contractually binding to you upon your transfer of currency (money order, cashier's check, or credit card) for purchase of your SDI Technologies product.

© 2008 SDI Technologies, Inc. All rights reserved

**Questions? Visit www.ihomeaudio.com
or call 1-800-288-2792 Toll Free**

iH110-062508-A

EXB

Download from Www.Somanuals.com.¹¹ All Manuals Search And Download.

Printed in China

Free Manuals Download Website

<http://myh66.com>

<http://usermanuals.us>

<http://www.somanuals.com>

<http://www.4manuals.cc>

<http://www.manual-lib.com>

<http://www.404manual.com>

<http://www.luxmanual.com>

<http://aubethermostatmanual.com>

Golf course search by state

<http://golfingnear.com>

Email search by domain

<http://emailbydomain.com>

Auto manuals search

<http://auto.somanuals.com>

TV manuals search

<http://tv.somanuals.com>