

HP Digital Entertainment Center User's Guide



i n v e n t

The only warranties for HP products and services are set forth in the express warranty statements accompanying such products and services. Nothing herein should be construed as constituting an additional warranty. HP shall not be liable for technical or editorial errors or omissions contained herein.

HP assumes no responsibility for the use or reliability of its software on equipment that is not furnished by HP.

This document contains proprietary information that is protected by copyright. No part of this document may be photocopied, reproduced, or translated to another language without the prior written consent of HP.

Hewlett-Packard Company
P.O. Box 4010
Cupertino, CA 95015-4010
USA

© 2004 Hewlett-Packard Development Company, L.P.

This product incorporates copyright protection technology that is protected by method claims of certain U.S. patents and other intellectual property rights owned by Macrovision Corporation and other rights owners. Use of this copyright protection technology must be authorized by Macrovision Corporation, and is intended for home and other limited viewing uses only unless otherwise authorized by Macrovision Corporation. Reverse engineering or disassembly is prohibited. Apparatus Claims of U.S. Patent Nos. 4,631,603, 4,577,216, 4,819,098, and 4,907,093 licensed for limited viewing uses only.

FireWire and iPod are trademarks of Apple Computer, Inc.

HP supports lawful use of technology and does not endorse or encourage the use of our products for purposes other than those permitted by copyright law.

Intel, Pentium, Intel Inside, and the Intel Inside logo are trademarks or registered trademarks of Intel Corporation or its subsidiaries in the United States and other countries/regions. Microsoft, the Microsoft logo, Windows, and Windows XP are U.S. registered trademarks of Microsoft Corporation.

The information in this document is subject to change without notice.

Warnings and notes

Color-coded warnings and notes with additional text contain important information.



A warning describes information you need to avoid possible personal injury or damage to equipment or data.

Text set off in this manner indicates that failure to follow directions could result in bodily harm or loss of life. Read and follow all warnings.



A note describes important information you need.

Table of Contents

Before You Begin	1	Connecting Audio	35
Welcome	1	Audio Overview	36
Benefits and Features	2	Audio Output Connectors	36
Functional Overview	3	Sound Connector Jacks.....	37
Front Panel	3	Speaker Types.....	37
Memory Card Reader	5	Speaker Configurations	38
Back Panel.....	6	Typical Audio Connection	40
Keyboard	10	TV Audio Connection	41
Wireless Keyboard Operation	12	Connecting TV Audio	41
Replacing the Keyboard Batteries	13	AV Receiver Audio Connection	42
Remote Control	14	AV Receiver Equipment Overview	42
Remote Control Buttons.....	14	2.0 Home Stereo Installation	43
Remote Control Operation	16	2.1 Home Stereo Installation	44
Installing the Remote Control Batteries	17	4.1 Home Theater Audio	45
Safety Information	19	5.1 Home Theater Audio	46
AC Power Safety Warnings	19	7.1 Home Theater Audio	47
Cleaning the HP Digital Entertainment Center.....	21	Digital Home Theater Audio	48
Shipping the HP Digital Entertainment Center	21	Powered Speaker Audio Connection	50
Installation Overview	23	2.1 Powered Speakers	51
System Audio/Video Connections.....	24	4.1 Powered Speakers	52
System Integration	24	5.1 Powered Speakers	53
System Diagram	26	7.1 Powered Speakers	54
Installation Guidelines	28	Digital Powered Speakers	55
Basic Set Up.....	29	Monitor Speakers	56
Setting up the HP Digital Entertainment Center	29	Audio In Connections	57
Inventory.....	31	FM Radio Antenna	58
Cables Included	32		

Connecting Video Out..... 59

Video Out Overview60

Video Out Connection Overview	60
Video Output Connectors	61
Component Video Settings.....	62
TV Display Overview	63
Audio and Video Switching Overview.....	63
Using the Remote Control with Your TV	64

Typical Video Out Connections.....65

Video Out to TV.....66

Video Out from AV Receiver to TV68

Video Out to Monitor70

Video Out to TV and Monitor.....71

Connecting TV Source In 73

TV Source Overview74

TV Signal Source Overview	74
TV Source Connectors Overview	74
TV Source Connectors.....	75

Typical TV Source Connections77

Cable Connection.....78

Cable Only.....	78
One Cable TV Box or Digital Cable Receiver	80
Two Cable TV Boxes, or Two Digital Cable Receivers	82

Satellite Connection84

One Satellite Receiver	84
Two Satellite Receivers	86

Infrared Transmitter Connection.....88

Infrared Transmitter Overview	88
Infrared Transmitter Installation.....	90

Antenna Connection92

Connecting Video Equipment.....95

Video Equipment Overview..... 96

Connectors	96
Video Equipment Connection Overview.....	97

Typical Video Equipment Connections 98

VCR Connection..... 99

VCR Direct in Connection	99
Wall to VCR to TV Using Coaxial Cable.....	100

Video Camera Connection 103

Connecting a Digital Video Camera	103
Connecting an Analog Camcorder	106

Connecting the Network 107

Peripheral Connection Overview 108

Typical Network Connections 110

Connecting the Wireless Network Antenna 111

Connecting a DSL/Cable Modem..... 113

Connecting Through a Router 114

USB Device Connection 115

Digital Still Camera.....	115
Other USB Devices	116

Connecting an HP Personal Media Drive 117

Installing an HP Personal Media Drive.....	118
Disconnecting an HP Personal Media Drive.....	119

Initial Configuration	121	Troubleshooting.....	141
Starting the HP Digital Entertainment Center for the First Time.....	122	Problems and Solutions	142
Installing the Keyboard Batteries (Initial)	122	Audio.....	142
Initial Start Up.....	122	Video.....	143
Syncing the Keyboard.....	123	System	145
Windows Welcome	125	Getting Help.....	151
Media Center First-Run.....	126	Help and Support Center	151
Required Set-up	126	HP Support	151
Optional Set-up	127	Warranty and Support Guide	152
If Your Connections Don't Work	128	Updates from HP	154
Register with HP	129	Microsoft Web Site.....	154
Set up Virus Protection	129		
Adjusting the Front Panel Display Brightness	129		
Configuring Audio	130		
Connecting Headphones	130		
Connecting a Microphone	130		
Adjusting the Volume	131		
Configuring Audio Output	132		
Configuring Video.....	134		
Configuring Video Output	134		
Adjusting the Desktop Display	137		
Configuring the Keyboard Buttons	138		
Transferring Old PC Information to Your New HP Digital Entertainment Center.....	138		
Installing Software	139		
Utility Programs.....	139		
		Appendix: Replacing the Hard Drive	155
		Important Information About Recorded TV Programs	155
		Procedure	155
		Index	159

Before You Begin

Welcome

Thank you for purchasing the HP Digital Entertainment Center. Your HP Digital Entertainment Center puts you in control of your complete home entertainment experience. Enjoy your TV, movies, music, photos, and home videos with one simple interface. Pause and replay live TV, and record your favorite TV shows, without a monthly fee. Capture, personalize, and create DVDs of your home movies, and back up your photos, music, or favorite TV programs onto DVD.

Use other entertainment equipment, like a TV, satellite receiver, and digital camera, with the HP Digital Entertainment Center to create an integrated

entertainment system. Access all of your TV programs, videos, pictures, music CDs, and DVDs using Microsoft's Media Center software and the remote control.

This *User's Guide* helps you to set up the HP Digital Entertainment Center to use with your audio/video system.

Chapter Contents:

"Functional Overview" on page 3

"Keyboard" on page 10

"Remote Control" on page 14



The HP Digital Entertainment Center

Benefits and Features

Benefits

- Complete home digital entertainment solution for your living room.
 - Watch, pause, and replay live TV on one channel while recording another (select models only).
 - Schedule future recordings with the complementary programming guide (no charge).
 - Wakes from standby to record scheduled shows.
 - Burn a DVD of your favorite TV shows or home videos.
 - Burn music and picture CDs.
 - Store audio CDs in an easy-to-use music jukebox.
 - Listen to your collection of MP3 and AAC music.
 - View and edit your favorite digital photos.
 - Play DVDs in 7.1 surround sound.
 - Store your digital content on the HP Personal Media Drive.
 - Download movies on demand.
 - Instant-message friends.
-

Product features

- Sophisticated, sleek, stackable case fits into your AV cabinet
 - HP Digital Entertainment Center (communication and information) for video, photo, music, and gaming
 - Built-in standard-definition TV tuner (dual tuners for select models only)
 - Personal video recorder (PVR)
 - Built-in FM radio tuner
 - Music jukebox with space for many songs
 - Photo/image management
 - HP Personal Media Drive
 - Television is the primary display
 - PC monitor can be a secondary display
 - Front status panel
 - CD/DVD player/recorder
 - 9-in-1 media card reader
 - Rear and front AV connectors:
 - Digital Audio Out: optical and coaxial S/PDIF 5.1 surround
 - Analog Audio Out: up to 7.1 channels
 - Video Out: DVI, VGA, S-video, Component, Composite Video
 - Ethernet 10/100/1000 network
 - Integrated 802.11b/g wireless network
 - Front AV, USB, and FireWire® (IEEE 1394) connectors for video capture
 - Remote control
 - Compact wireless keyboard with integrated trackball mouse
-

Functional Overview





Front Panel

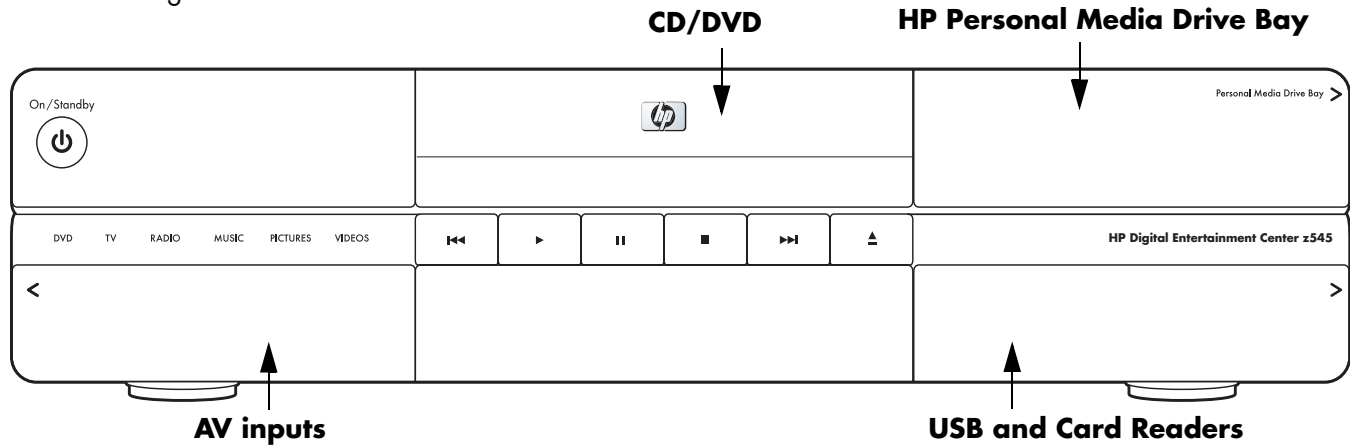





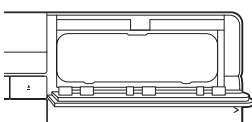

The following illustration shows the HP Digital Entertainment Center front panel.

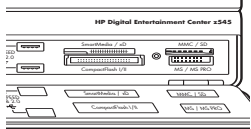
Your model might not have all features.

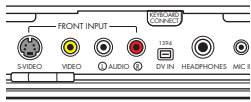

Front panel

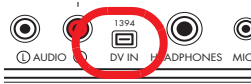
Item	Function	Comments
	Power button and LED Press and hold button four seconds to turn off. Push for standby.	Solid blue: On Solid amber: Standby
	CD/DVD	CD/DVD player/recorder Push the Eject button to open. Push the tray or Eject button to close.
	Transport buttons	Replay, Play, Pause, Stop, Skip, Eject
	Mode status LEDs	White indicates DVD, TV, radio, music, pictures, videos, activities in Media Center.
	Personal Media Drive Bay	Removable HP Personal Media Drive behind top right door

Item	Function	Comments
	9-in-1 Memory card readers SmartMedia/xD, MMC/SD, CompactFlash I/II, Micro drive, MS/MS-Pro USB 2.0 (2)	Card readers behind lower right door LED: Green (with media inserted) Off (no media inserted) See "Memory Card Reader" on page 5.
	Media info display	Front-panel text content displayed from Media Center
	<i>Behind Left Door</i>	<i>Front AV inputs — see below</i>
	Keyboard connect switch for wireless keyboard synchronization	Blinking green LED indicates keyboard activity. Special blink status indicates sync with keyboard.
	S-video In Source 3	Y/C video, Analog 4-pin
	Video In Source 3	Composite Video RCA jack
	Audio In Source 3	White: left Red: right, RCA jacks
	1394	FireWire (IEEE 1394), 4-pin input-output for Digital Video
	Headphone Out	1/4-inch jack
	Microphone In	1/8-inch mini-jack

Memory Card Reader

The HP Digital Entertainment Center card readers are on the front panel, located behind a door. Four horizontal card slots accept memory cards.

An in-use light-emitting diode (LED) indicates card reader activity when the HP Digital Entertainment Center is reading or writing data. Wait until the LED stops blinking before removing media.

Digital cameras and other digital devices use memory cards, or media, to store digital picture files.

Two USB 2.0 connectors are also included.



Removing media when the in-use light is blinking may cause damage.

Your model might not have all features.

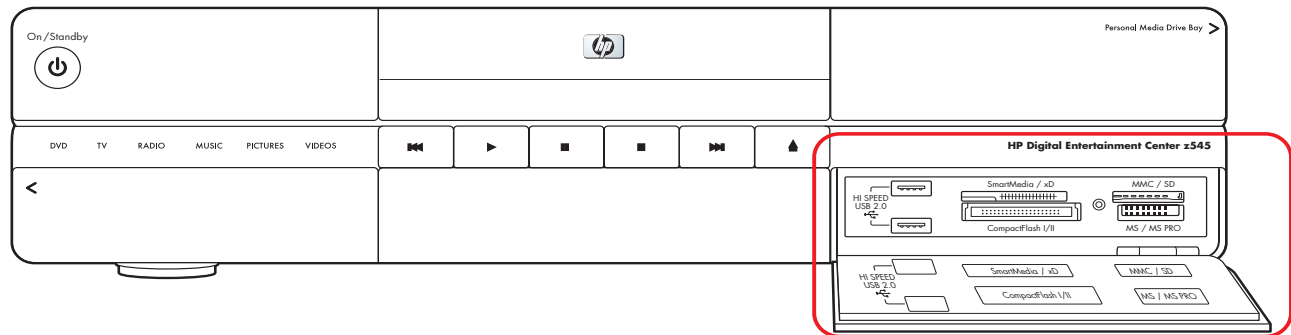



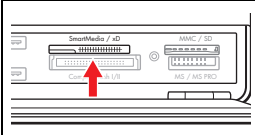
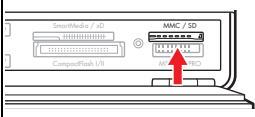
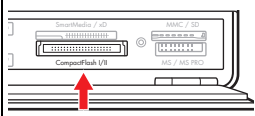
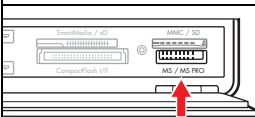



Memory card readers

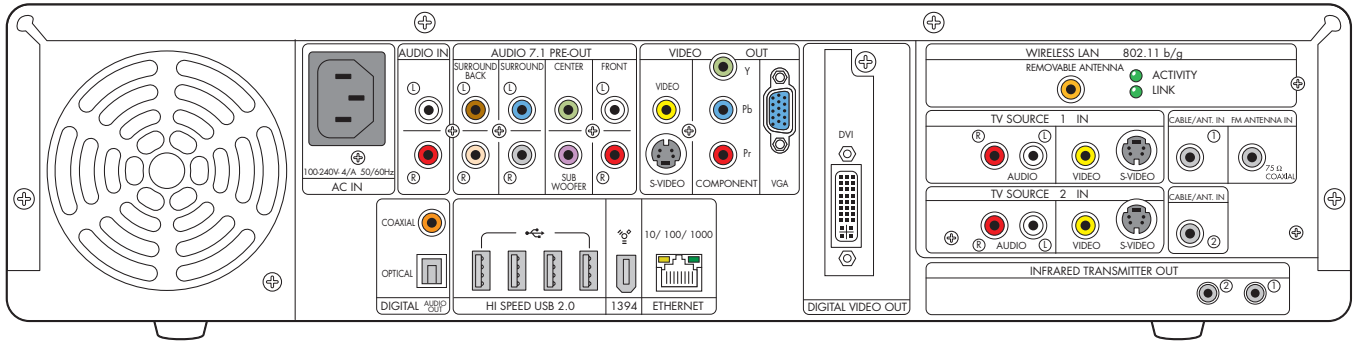





Item	Name	Location	Supports	Insert media
	SmartMedia/xD	Upper-left slot	SmartMedia (SM) memory card xD media	Facing up
	MMC/SD	Upper-right slot	MultiMediaCard (MMC) Secure Digital (SD) memory card	Facing up
	CompactFlash I/II Micro drive	Lower-left slot	CompactFlash Type I, II media Micro drive disk drive	Receptacle edge (holes)
	MS/MS-Pro	Lower-right slot	Memory Stick (MS) Memory Stick (MS-Pro)	Facing up





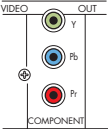

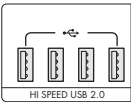

Back Panel



The following illustration shows the HP Digital Entertainment Center back panel.
(Location and number of connectors may vary by model.)

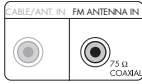

Item	Connector	Type	Color	Supported format
	Audio In (Source 4)	RCA jacks	White: left Red: right	Analog Stereo
	Audio 7.1 Pre-Out Surround Back	RCA jacks	Brown: left Beige: right	Analog: 7.1
	Audio 7.1 Pre-Out Surround	RCA jacks	Blue: left Grey: right	Analog: 7.1, 6.1, 5.1, 4.1
	Audio 7.1 Pre-Out Center/Subwoofer	RCA jacks	Green: center Purple: subwoofer	Analog: 7.1, 6.1, 5.1
	Audio 7.1 Pre-Out Front	RCA jacks	White: left Red: right	Analog Stereo: 7.1, 6.1, 5.1, 4.1
	Digital Audio Out	Coaxial	Orange	S/PDIF 5.1 only

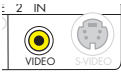
Item	Connector	Type	Color	Supported format
	Digital Audio Out	Optical	Gray	S/PDIF 5.1 only
	Video Out (Composite)	RCA jack	Yellow	Analog
	S-video Out	Y/C video 4-pin	Black	Analog: Up to 1024 x 768 @ 60 Hz
	Component Video Out (interlaced or progressive scan)	3 RCA jacks	Green: Y Blue: Pb Red: Pr	Analog: Default: 480i; all-interlaced display up to 1080i, Plus 480p, 720p (Not all modes support DVD playback due to content protection.)
	VGA Out	15-pin D-sub	Blue	Analog: Up to 2048 x 1536 with panning depending on display size
	Digital Video Out (DVI)	DVI-I 29-pin D-sub Digital/ analog	White	Digital: Up to 1600 x 1200 Up to 2048 x 1536 with panning depending on display size
	USB 2.0 (High Speed)	4 ports	Silver	USB 2.0
	1394	6-pin DV input/output for digital video or other device	Silver	FireWire (IEEE 1394)

Item	Connector	Type	Color	Supported format
	Ethernet 10/100/1000	RJ-45	N/A	10/100/1000
	Wireless LAN	Removable Antenna	Gold	802.11b/g
	LEDs (2) Activity: Blinks when transmits/ receives data	Link: Solid green when wireless LAN is enabled and connected. Blinks when wireless LAN is scanning.		Wireless LAN 802.11b, 802.11g
	Audio TV Source 1 In	RCA jacks	White: left Red: right	Analog
	Video (Composite) TV Source 1 In	RCA jack	Yellow	Analog: Up to 1024 x 768 @ 60 Hz
	S-video TV Source 1 In	Y/C video Analog 4-pin	Black	Analog: Up to 1024 x 768 @ 60 Hz
	Cable/Antenna in 1	Coaxial	Silver	RF
	FM Antenna In	75 Ohm Coaxial	Silver	FM radio, RF
	Audio TV Source 2 In (select models only)	RCA jacks	White: left Red: right	Analog
	Video (Composite) TV Source 2 In (select models only)	RCA jack	Yellow	Analog: Up to 1024 x 768 @ 60 Hz

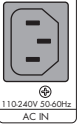



Item	Connector	Type	Color	Supported format
	S-video TV Source 2 In (select models only)	Y/C video Analog 4-pin	Black	Analog: Up to 1,024 x 768 @ 60 Hz
	Cable/Antenna in 2 (select models only)	Coaxial	Silver	RF
	Infrared Transmitter Out	2 outputs 1/8-inch mini- jack	Silver	IR Blaster Remote infrared
	AC In	AC 110–240V 50–60 Hz	Black	Power

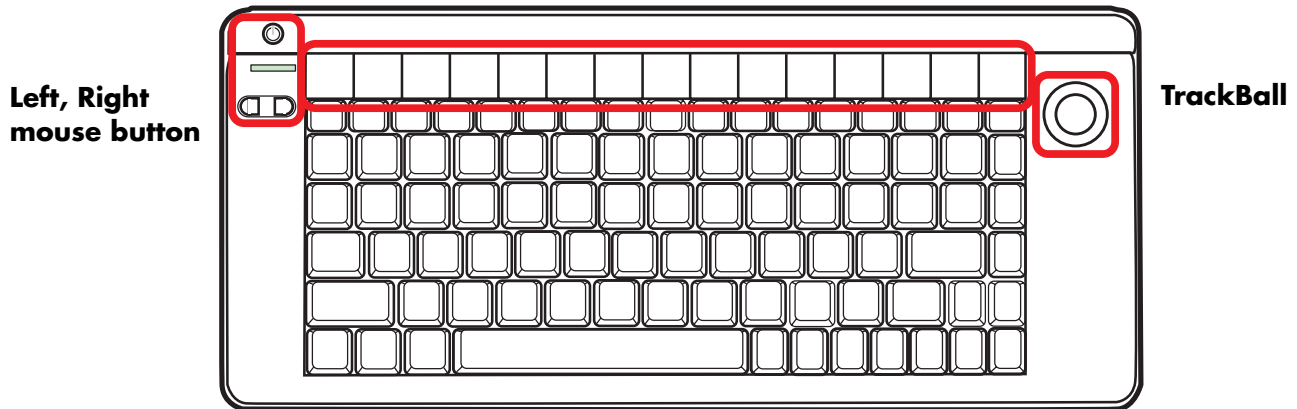



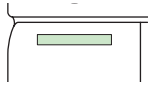
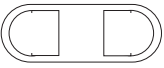







Keyboard

The following illustration shows the HP Digital Entertainment Center wireless keyboard.



The following table shows the wireless keyboard features and function keys from left to right.

Icon	Item	Description
	On/Standby	Turns HP Digital Entertainment Center on, when in Standby. Places HP Digital Entertainment Center in standby.
	Activity LED	Amber: Caps lock on Green: Key or mouse button activity
	Mouse button left, right	Left-click, right-click
	Select left	Moves cursor to previous selection.
	Select right	Moves cursor to next selection.
	Back	Displays previous recently viewed browser page.
	Forward	Displays next recently viewed browser page.
	Internet	Opens your Internet browser.

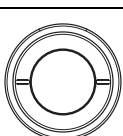
Icon	Item	Description
 E-mail	E-mail	Opens an Internet e-mail page.
 Messenger	Messenger	Opens your messenger program.
 Minimize	Minimize	Minimizes Media Center application.
 Maximize	Maximize	Maximizes Media Center application.
 Media Center	Media Center	Starts Media Center.
 Previous	Previous	Selects media previous track.
 Play	Play	Plays media.
 Pause	Pause	Pauses media.
 Next	Next	Selects next media track.
 Vol -	Vol -	Decreases speaker volume.
 Vol +	Vol +	Increases speaker volume.
 Mute	Mute	Turns speaker sound on and off.
	Trackball	Moves cursor on screen.



The Internet, E-mail, and Messenger buttons can be reconfigured to open a Web site or software program. See "Configuring the Keyboard Buttons" on page 138. Refer to the *Media Center Edition 2005 Software Guide*.

Wireless Keyboard Operation

Your HP Digital Entertainment Center includes a wireless keyboard that uses a built-in receiver/transmitter instead of a connector cable to communicate. The Keyboard Connect button, behind the lower-left door of the HP Digital Entertainment Center front panel, has an LED that indicates receiver activity. Approximate range is 12 feet (3.66 meters).



Use only alkaline batteries in the keyboard.

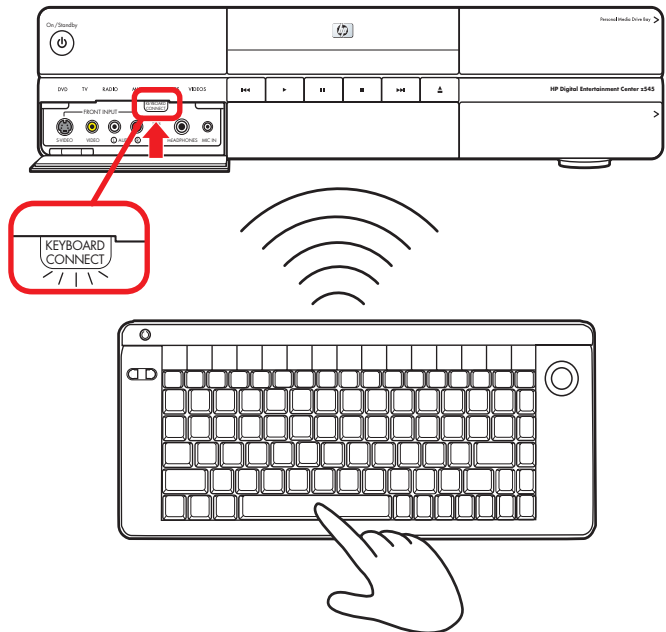

Replacing the Keyboard Batteries

Keep spare batteries on hand. Battery life will vary with the use of the system.

- 1 Slide the battery cover off the back of the keyboard.

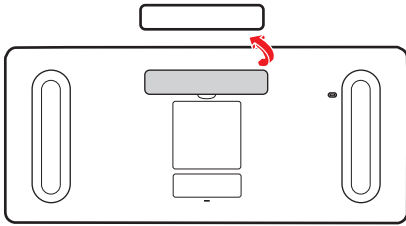

- 2 Insert four AA batteries (alkaline). Make sure the battery positive and negative ends are inserted correctly!

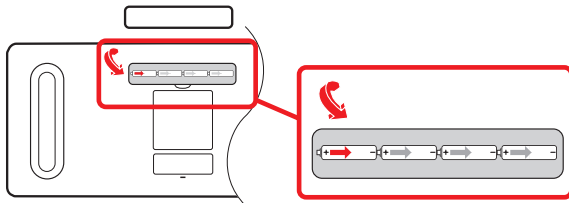

- 3 Replace the battery cover.

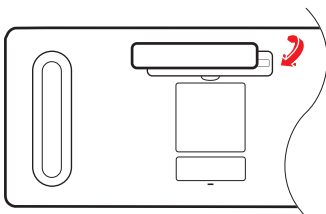















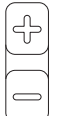

- 4 Make sure the HP Digital Entertainment Center is powered on.
- 5 Test the keyboard.
 - The keyboard is set to connect to the HP Digital Entertainment Center automatically.
- 6 If the keyboard does not operate:
 - a Check the battery orientation.
 - b Sync the keyboard. See "Syncing the Keyboard" on page 123.

If you have no batteries and must use a keyboard, attach a USB keyboard to the back or front panel. You can also use the remote for many functions.

Remote Control



Remote Control Buttons

(Features and location may vary.)

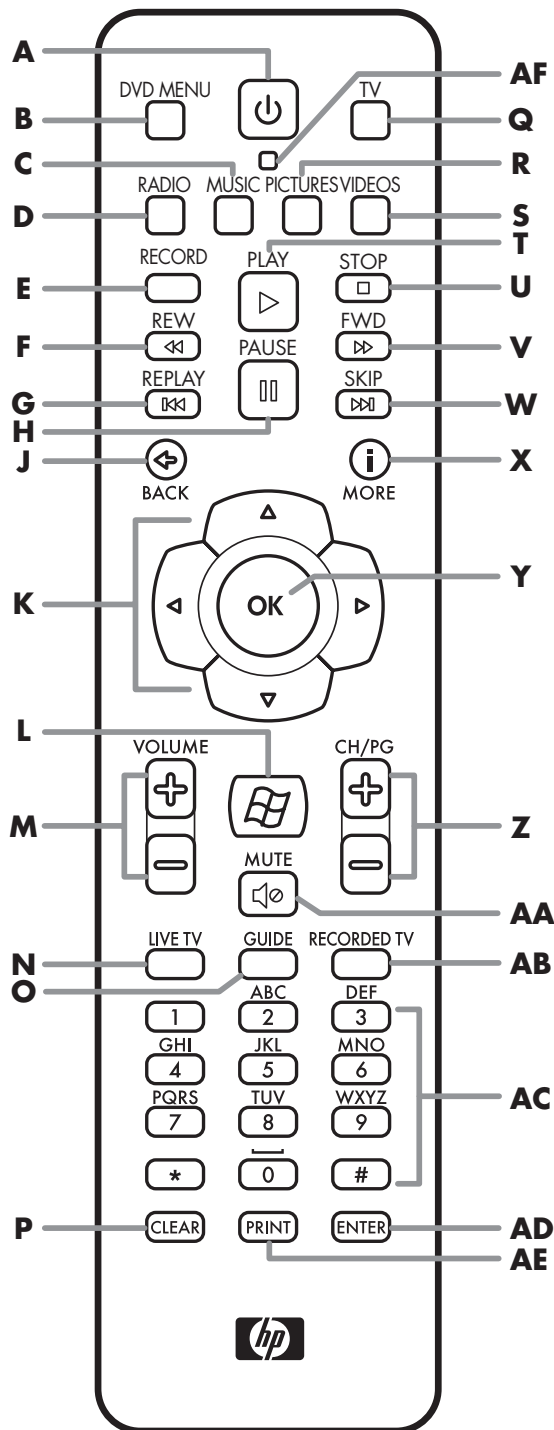
A Standby	Puts the HP Digital Entertainment Center into and out of a power-reduced standby state. It does not turn the HP Digital Entertainment Center off.		K Arrow	Buttons move the cursor to navigate within all Media Center windows. They also move forward and backward through slide-show images.	
B DVD Menu	Opens Play DVD window in Media Center or opens the main menu of a DVD movie, if available.	DVD MENU 	L Media Center	Opens Media Center to the main menu.	
C Music	Starts My Music.	MUSIC 	M Volume	Increases (+) and decreases (-) sound.	VOLUME 
D Radio	Starts FM Radio.	RADIO 	N Live TV	Is a shortcut to the full-screen view of live TV. It also moves to the current point in a live TV program after pausing live TV.	LIVE TV 
E Record	Records a selected television program and stores it on the hard disk drive.	RECORD 	O Guide	Opens the Television Program Guide to display available TV channels and programs to watch and record.	GUIDE 
F Rew	(Rewind) moves the media backward (press button for three speeds).	REW 	P Clear	Deletes the selection and works as the Backspace key does on a keyboard.	CLEAR 
G Replay	Rewinds live or recorded TV eight seconds, or beginning of music track, or DVD chapter.	REPLAY 	Q TV	Starts My TV.	TV 
H Pause	Pauses audio and video tracks and live or recorded TV programs.	PAUSE 	R Pictures	Starts My Pictures.	PICTURES 
J Back	Returns to the previous window within Media Center.	 BACK	S Videos	Starts My Videos.	VIDEOS 



T Play	Plays the selected media.	
U Stop	Stops the selected media.	
V Fwd	(Fast-forward) moves media forward (press button for three speeds).	
W Skip	Moves media forward – for example, 30 seconds in videos and live TV, or one music track, or one DVD chapter.	
X More (i)	Displays available information about a selected media file and displays more information and options.	
Y OK	Selects the desired action or window option. It acts as the Enter key.	
Z CH/PG	Up (+) and down (-) change the TV channel or move pages up and down, depending on available options.	
AA Mute	Turns sound off. The word <i>Mute</i> is displayed on the Media Center screen when Mute is turned on.	
AB Recorded TV	Opens the Recorded TV window.	
AC 0 to 9, #, *	Are the numeric keypad buttons to change channels or enter text into the Media Center search or text box.	

AD Enter	Selects the desired action or window option. In full-screen mode, press Enter to jump to the last channel you were watching.	
AE Print	Prints selected content on the screen.	
AF LED	Activity indicator lights on pressing a button.	

Remote Control Operation

Use the remote control to open the Media Center program; view TV, record TV programs, play previously recorded TV programs, and play music, movies, or video. See "Using the Remote Control" in the *Media Center Edition 2005 Software Guide* for detailed instructions on using the features of the remote control.

To use the remote control, just point it at the HP Digital Entertainment Center and press a button. Use the remote control at a maximum distance of 26 feet (8 meters) from the remote sensor and at a maximum of 45 degrees (90 degrees total) from the center of the remote sensor.

The remote control will not operate until the HP Digital Entertainment Center is powered on and fully booted up.

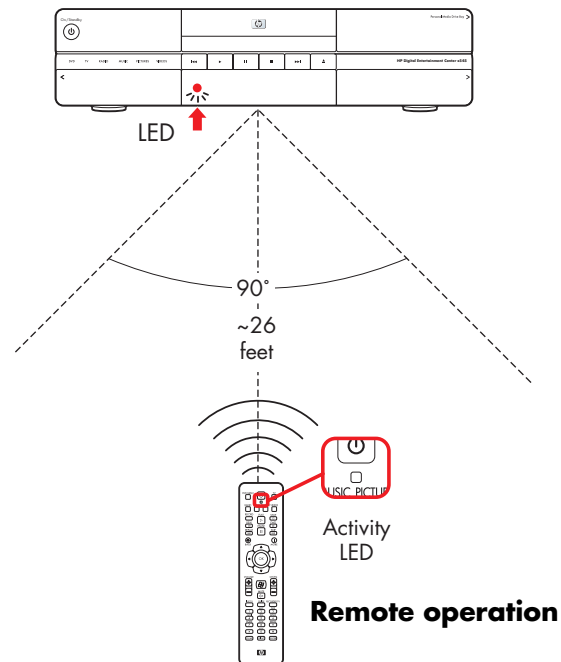

Media Center must be in fullscreen (or have focus) for consistent remote control operation. Performance in your room may vary.

Installing the Remote Control Batteries

- 1** Slide the battery cover off the back of the remote control.
- 2** Insert the two AA alkaline batteries (provided). Make sure the battery positive and negative ends are inserted correctly!
- 3** Replace the battery cover.
- 4** Test the remote control by pressing any key. The indicator light should blink.

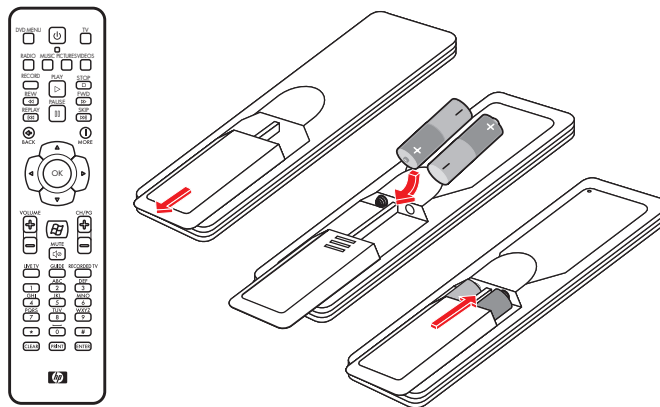

Use only alkaline batteries in the remote.

Safety Information

Read Instructions before installing or operating your HP Digital Entertainment Center.

Follow the instructions provided.

Heed all safety warnings and notes.

Refer to the *Warranty and Support Guide* for additional safety information.

Chapter Contents:

"AC Power Safety Warnings" on page 19

"Cleaning the HP Digital Entertainment Center" on page 21

"Shipping the HP Digital Entertainment Center" on page 21



Please read this important safety information.

AC Power Safety Warnings



- **Do not open top cover.**
- **Risk of electric shock.**
- **No user-serviceable parts inside.**

Use the right AC source. The power supply is pre-set for the country/region in which you purchased the HP Digital Entertainment Center. If you move to another country/region, please make sure you check its voltage requirements before plugging your HP Digital Entertainment Center into an AC power outlet.

A power cord is included with your HP Digital Entertainment Center. If another cord is used, use only a power source and connection appropriate for this HP Digital Entertainment Center.

Install the system near an AC outlet. The AC power cord is your HP Digital Entertainment Center's main AC disconnecting device and must be easily accessible at all times. For your safety, the power cord provided with your system has a grounded plug. Always use the power cord with a properly grounded wall outlet to avoid the risk of electric shock.

To reduce the possibility of an electric shock from the telephone network, plug your system into the AC outlet before connecting it to the DSL/telephone line. Also, disconnect the DSL/telephone line before unplugging your system from the AC power outlet.

This product has not been evaluated for connection to an "IT" power system (an AC distribution system with no direct connection to earth, according to IEC 60950).

Ground your system. To reduce the risk of electric shock or damage to your equipment, do not disable the power cord grounding feature. The grounding plug is an important safety feature. Connect the equipment to a grounded (earthed) power outlet.

For your safety, be sure that the grounded power outlet into which you plug the power cord is easily accessible to the operator and is located as close to the equipment as possible.

Never pull on the cord. Disconnect the HP Digital Entertainment Center by grasping the plug firmly and pulling it from the power outlet. Never disconnect the HP Digital Entertainment Center by pulling the cord.

Install your HP Digital Entertainment Center near an outlet that you can easily reach. Do not allow anything to rest on the power cord. Do not walk on the cord.

Use surge protection. To protect your HP Digital Entertainment Center, and other equipment, connect all power cords for your system and its peripheral devices (such as a printer, or scanner) to a surge protection device such as a power strip with surge protection or Uninterruptible Power Supply (UPS).

Not all power strips provide surge protection; the power strips must be specifically labeled as having this ability. Use a power strip whose manufacturer offers a Damage Replacement Policy so you can replace your equipment if surge protection fails.

Use the right power source. Use only a power source and connection appropriate for this HP Digital Entertainment Center, as indicated on the label/back plate of the HP Digital Entertainment Center.

Be sure the total ampere rating of the products connected to the outlet does not exceed the current rating of the electrical outlet, and the total ampere rating of the products connected to the cord does not exceed the rating of the cord. Look on the power label to determine the ampere rating (AMPS or A) for each device.

Outdoor Antenna grounding — If an outside antenna or cable system is connected to the product, be sure the antenna or cable system is grounded so as to provide some protection against voltage surges and static build-up charges. Article 810 of the National Electrical Code, ANSI/NFPA 70, provides information with regard to proper grounding of the mast and supporting structure, grounding of the lead-in wire to an antenna discharge unit, connection to grounding electrodes, and requirements for the grounding electrode. Refer to the *Warranty and Support Guide* for additional safety information.

Lightning — For added protection of any HP product during a lightning storm, or when it is left unattended and unused for long periods of time, unplug the product from the wall outlet and disconnect the antenna or cable system. This will prevent damage to the product due to lightning and power-line surges.

Power Lines — An outside antenna should not be located in the vicinity of overhead power lines or other electric light or power circuits, or where it can fall into such power lines or circuits.

Cleaning the HP Digital Entertainment Center

The HP Digital Entertainment Center is a high-quality device that requires special care when cleaning. To clean the HP Digital Entertainment Center, follow these steps:

- 1 Turn off the HP Digital Entertainment Center and connected equipment.
- 2 Unplug the HP Digital Entertainment Center from the wall outlet before cleaning. Use a soft dry cloth for cleaning.
- 3 Plug in the HP Digital Entertainment Center.
- 4 Turn on connected equipment and the HP Digital Entertainment Center.



Do not use liquid cleaners or aerosol cleaners to clean your HP Digital Entertainment Center. Do not use benzene, thinner, ammonia, or any other volatile substances. These chemicals may damage your unit.

Shipping the HP Digital Entertainment Center

Keep the original packing box in a storage area. You may need it later if you move or ship your HP Digital Entertainment Center.

Installation Overview

This chapter provides information on your system and describes how to connect your HP Digital Entertainment Center to your audio/video (AV) equipment in detail. You may find connection details that won't be in the basic *Start Here* Booklet.

The *Start Here* Booklet works with this *User's Guide*. Take a few minutes to look at the *Start Here* Booklet before you read this chapter. You may find the information you need there.

The HP Digital Entertainment Center is very versatile and works with a wide variety of basic, typical, and advanced multimedia systems.

The installation process is divided into four major areas: Audio, Video, TV Source In, Network.

The setup can take some time, depending on your system, and may require additional cables.

Chapter Contents:

"System Audio/Video Connections" on page 24

"Basic Set Up" on page 29

"Inventory" on page 31



Read the Important Safety Information before you install the HP Digital Entertainment Center. See "Safety Information" on page 19.

System Audio/Video Connections

System Integration

The HP Digital Entertainment Center incorporates many functions into one unit:

- An **Internet** connection through a wireless or wired network, using an Internet service provider, allows the HP Digital Entertainment Center to access the Television Program Guide and Internet content sources.
- A **cable** connection from a set-top-box or antenna hookup allows the TV tuner inside the HP Digital Entertainment Center to select the TV channels.
- An **Infrared Transmitter** (IR blaster) connection to a set-top-box from the HP Digital Entertainment Center allows the HP Digital Entertainment Center to select the set-top-box channels from the HP Digital Entertainment Center remote control.
- **Audio** Outputs from the HP Digital Entertainment Center to your TV speakers or AV receiver allow up to 7.1 surround sound.
- **Video** Outputs from the HP Digital Entertainment Center to your TV or AV receiver allow you to watch TV and to view the HP Digital Entertainment Center display.
- An **FM** radio antenna connection allows the FM tuner inside the HP Digital Entertainment Center to select the FM radio channels.
- The wireless **keyboard** with **trackball** or **remote control** allow you to operate the HP Digital Entertainment Center from the comfort of your couch.

How you connect the HP Digital Entertainment Center into your system depends on how you want to use it. The HP Digital Entertainment Center functions as a peripheral media source, with DVD and personal video player/recorders built in. Your AV receiver or TV functions as your audio/video output switch.

To watch and record TV, video, and audio, you must first connect the HP Digital Entertainment Center inputs to your video, audio, and network sources.

- To play back audio/video, you must connect the HP Digital Entertainment Center outputs to your sound system and TV/display.
- To record audio/video, you must connect the HP Digital Entertainment Center inputs to your video source, such as a cable set-top-box, satellite receiver, or antenna.
- To update the Television Program Guide and use the Internet, you must also connect to a home network or DSL/cable modem.

If your HP Digital Entertainment Center has the dual-tuner option, each tuner must be connected to the same TV source. You can connect two cable set-top-boxes, or two, satellite receivers, or an antenna with cable splitter. The Television Program Guide only supports one TV service provider channel line-up.

Audio and video output cables from the HP Digital Entertainment Center can be:

- Routed through an AV receiver to provide an audio and video signal to your TV.

Or

- Routed directly to your TV.

Imagine the flow of your television signal into and out of the HP Digital Entertainment Center. To watch and record TV, your TV signal (for example, from a satellite) must flow into the HP Digital Entertainment Center. Then, for you to watch live or recorded TV, the HP Digital Entertainment Center must send the recorded TV shows out to your TV.

The following illustration shows the audio and video signal routed from the satellite or cable receiver source to the HP Digital Entertainment Center, then through an AV receiver to your TV:

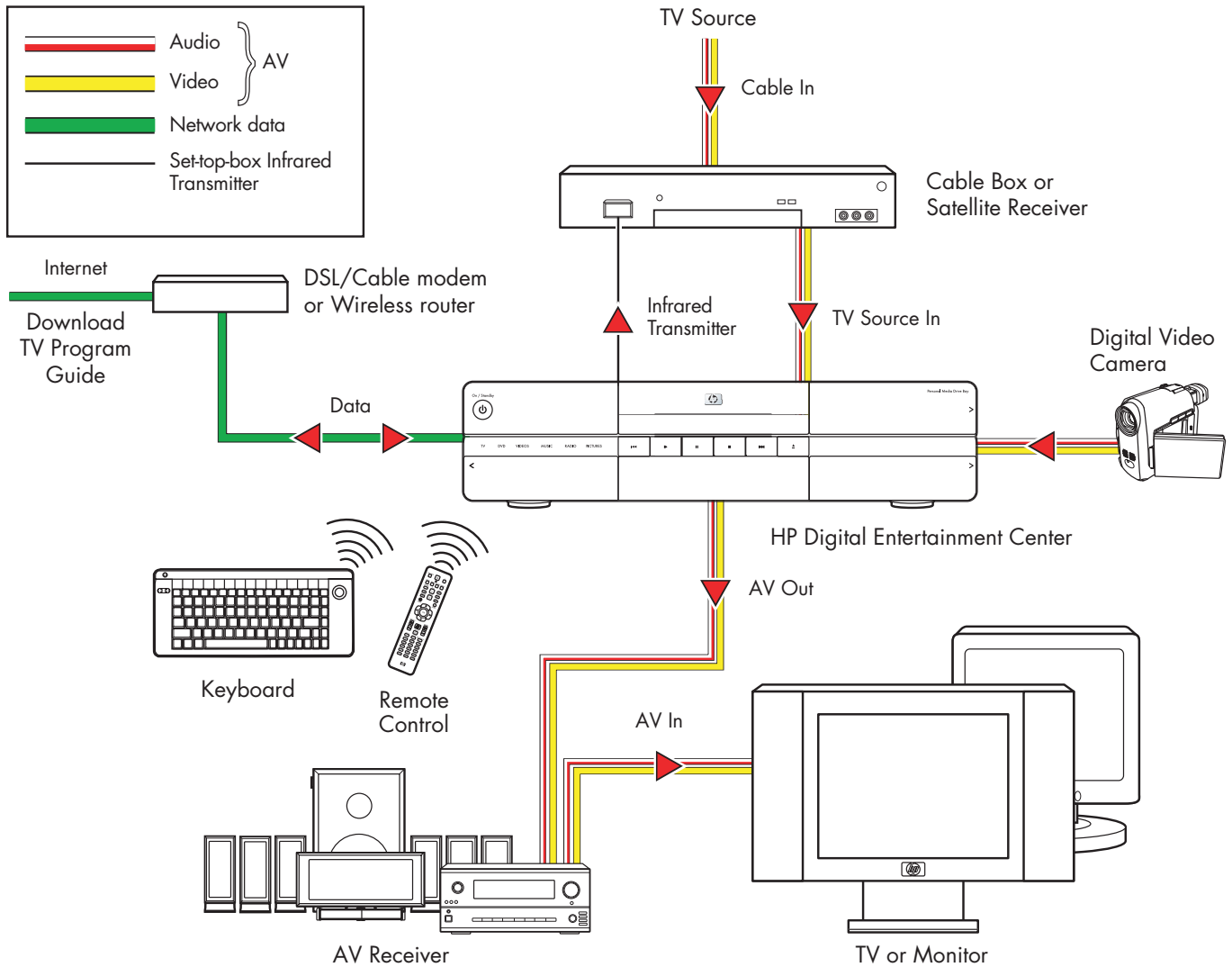

Audio/Video flow

System Diagram

Back Panel

(Configurations may vary.)

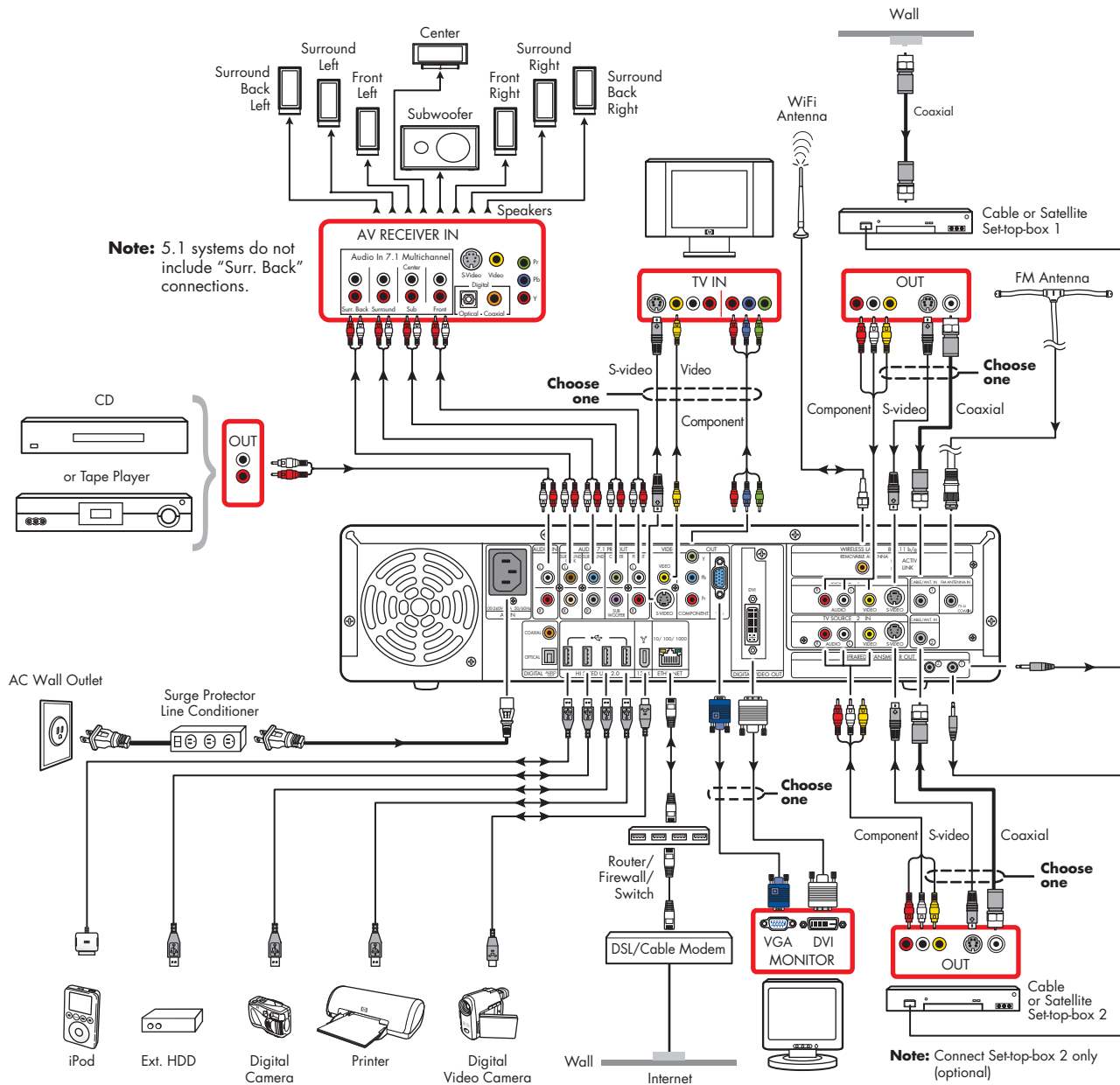

Front Panel

(Configurations may vary.)

The following illustration shows a typical HP Digital Entertainment Center system front panel installation:

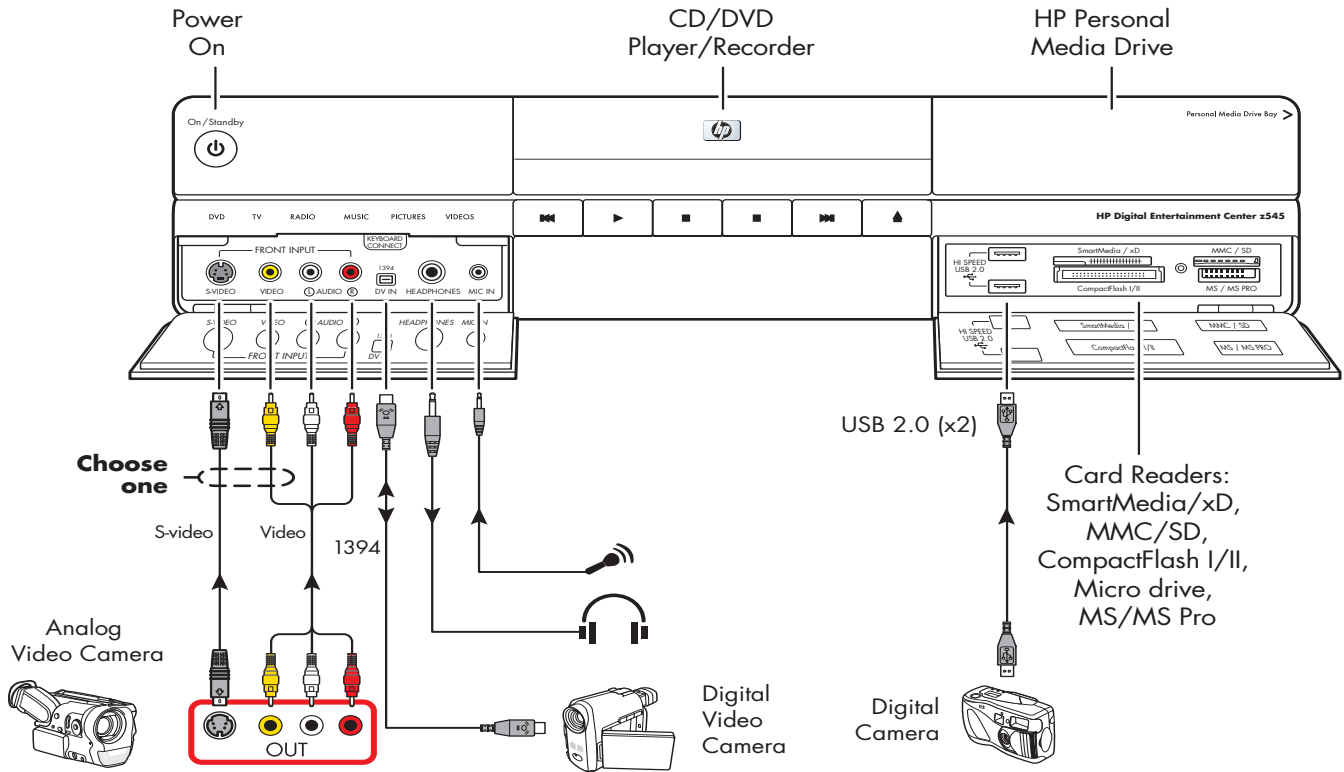

Installation Guidelines

To enhance the performance and extend the life of your HP Digital Entertainment Center:

- This product is heavy. Exercise caution when lifting or moving.
- Installing your HP Digital Entertainment Center in an open back AV cabinet is required. Use of an open front cabinet is highly recommended. Keep the rear of the AV cabinet open across the width of the HP Digital Entertainment Center back panel for adequate cooling.
- Place your HP Digital Entertainment Center on a stable, supported surface. Do not drop or place it on an unstable surface.
- Keep your HP Digital Entertainment Center in a well-ventilated area, away from excessive light, heat or moisture.
- Keep ventilation slots clear of obstructions such as equipment or papers. The HP Digital Entertainment Center automatically turns off if it gets too hot.
- Put your HP Digital Entertainment Center into standby when not in use. Preset recordings only start when the HP Digital Entertainment Center is on or in standby.
- Adjust only those controls that are described in the operating instructions.
- Do not open your HP Digital Entertainment Center cabinet or attempt to service this product yourself. If your HP Digital Entertainment Center is not operating properly or has been dropped or damaged, contact your HP authorized dealer, reseller, or service provider.

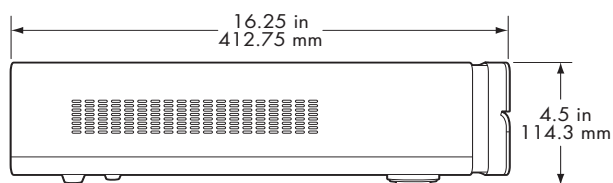
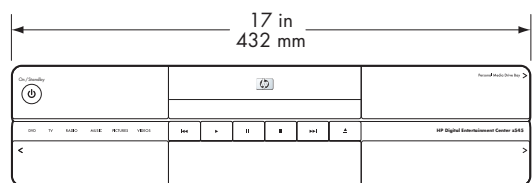
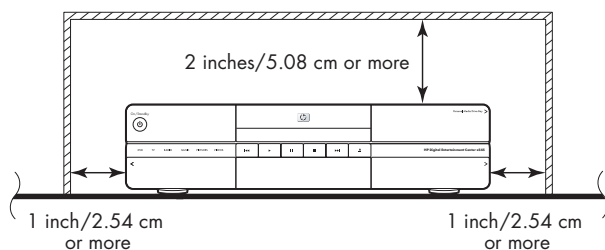



Leave slots and openings in the HP Digital Entertainment Center cabinet open for ventilation. These openings must not be blocked or covered. Never push objects of any kind into cabinet slots or other openings.

Basic Set Up

Follow the steps in the *Start Here* Booklet to set up the HP Digital Entertainment Center.

Most of the hardware devices such as the monitor and printer can be connected at the back panel of the HP Digital Entertainment Center.

Some peripheral devices, such as a digital video camera, can be plugged into the connectors on the back panel or the front panel (behind lower doors) of the HP Digital Entertainment Center.

Setting up the HP Digital Entertainment Center

The basic steps to set up the HP Digital Entertainment Center are on the *Start Here* Booklet as follows. Your system may be different. See the referenced sections for detailed information on each step.

Before you begin:

- Read "Safety Information" at the beginning of this book.
- Refer to the *Start Here* Booklet as a guide to connect your HP Digital Entertainment Center.



Read the Important Safety Information before you install the HP Digital Entertainment Center. See "Safety Information" on page 19.

Required Steps

- 1** Unpack the box contents.
 - a** Take inventory. See "Inventory" on page 31. Identify the items included with your HP Digital Entertainment Center.
 - b** Identify equipment you will need that is not supplied.
 - c** Place the HP Digital Entertainment Center where you can easily reach the back panel.
- 2** Determine how you will connect the HP Digital Entertainment Center to your system.
- 3** Connect the audio cables. See "Typical Audio Connection" on page 40.
 - a** Audio In (optional)
 - b** Audio Out (to TV, AV receiver, speakers)
 - c** Digital Audio Out
- 4** Connect the Video Out to the TV or display. See "Typical Video Out Connections" on page 65.

5 Connect the TV Source 1 In audio/video cables to cable TV, digital cable, or satellite receiver set-top box 1. See "Typical TV Source Connections" on page 77.

- a** Cable/antenna.
- b** Cable TV box, digital cable box, or satellite receiver with stereo audio and video: S-video, composite, or coaxial.
- c** Connect the Source 2 In audio/video cables to cable TV box, digital cable box, or satellite receiver 2 (select models only).
- d** Connect the Infrared Transmitter 1 to cable TV box, digital cable box, or satellite receiver 1.
- e** Connect the Infrared Transmitter 2 to cable TV box, digital cable box, or satellite receiver 2 (select models only).

6 Connect the FM radio antenna. See "FM Radio Antenna" on page 58.

7 Connect the Internet network cables. See "Typical Network Connections" on page 110.

- a** DSL/cable modem to Internet (Ethernet)
- b** Wireless antenna

8 Optional Step (recommended after basic setup)

Connect any additional rear panel devices (optional). See "Peripheral Connection Overview" on page 108.

- a** FireWire (IEEE 1394) port
- b** USB devices, such as printers or scanners (up to 4)

9 Optional Step (recommended after basic setup)

Connect front panel devices (optional). See "Peripheral Connection Overview" on page 108.

- a** FireWire (IEEE 1394) port.
- b** USB devices, such as printers or scanners (up to 2).
- c** VCR or analog video camera.
- d** Insert the removable hard drive (optional).

Required Steps (continued)

10 Pull the tab on the keyboard to activate batteries. See "Installing the Keyboard Batteries (Initial)" on page 122.

11 Insert the remote control batteries. See "Installing the Remote Control Batteries" on page 17.

12 Place the HP Digital Entertainment Center on a flat stable surface with the following clearances:

- Top: 2 inches (5.08 cm)
- Side: 1 inch (2.54 cm)
- Back: open cabinet

See "Safety Information" on page 19.

13 Turn on all equipment, then turn on the HP Digital Entertainment Center. See "Starting the HP Digital Entertainment Center for the First Time" on page 122.







14 Complete the initial startup and registration. See "Windows Welcome" on page 125.

- a** Follow the onscreen instructions.
- b** Set up Media Center.

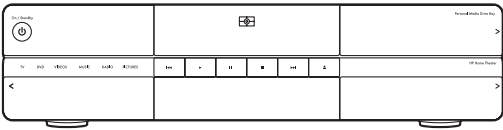
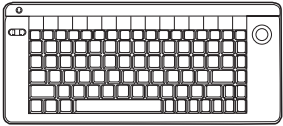
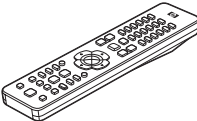
Begin using your system. See the *Media Center Edition 2005 Software Guide*.

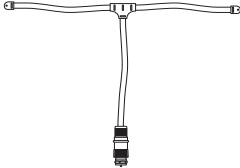



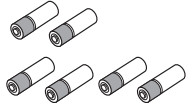



Inventory

The following items are supplied with the HP Digital Entertainment Center:

Name	Picture	Description
HP Digital Entertainment Center unit		See "Functional Overview" on page 3.
Keyboard		See "Keyboard" on page 10.
Remote control		See "Remote Control" on page 14.
Cables		See "Cables Included" on page 32.
FM antenna		Antenna for FM radio, 75 ohm coaxial. See "FM Radio Antenna" on page 58.
Wi-Fi antenna		Antenna for Wireless LAN 802.11 b/g, removable. See "Connecting the Wireless Network Antenna" on page 111.
Documentation		Printed documentation is included.
DVD recovery disk x2		Refer to the <i>Warranty and Support Guide</i> .
Batteries: AA x 6		2 for remote (in package), 4 for keyboard (inside keyboard).

Cables Included











Your HP Digital Entertainment Center comes with the following cables.

Cable	Name	Description
	Stereo	RCA Red, White ends. Used for Audio Out.
	DVI-D	Digital video out. Connect to DVI-I or DVI-D input of the HDTV or monitor.
	S-video	Black. Used for Video Out.
	Coaxial Digital Audio	SPDIF. Used for Digital Audio Out.
	Infrared Transmitter (2 with dual tuner option)	IR Blaster cable. Used for set-top-boxes.
	Coaxial (2 with dual tuner option)	Used for TV source input from cable set-top-boxes, or antennas.
	Coaxial Splitter (dual tuner option)	Used with coaxial cable for dual tuners only.
	AC Power	Black 125V [~] 10A.

You must purchase additional cables separately. See "Optional Cables not Included" on page 33 for additional cables that you may need.

Optional Cables not Included

You might need the following extra cables (these items are not provided with the HP Digital Entertainment Center).

Cable	Name	Max quantity	Description
	Stereo and Video (Composite)	4	RCA Red, White, Yellow ends. Used for TV Source In connector.
	Stereo	8	RCA Red, White ends. Used for Audio In/Out connectors.
	Component video	1	RCA Red, Blue, Green ends. Plug cable into a connector such as Component Video Out. Used for Progressive Scan component video.
	S-video	4	Y/C, 4-pin. Plug cable into an S-video connector such as S-video Video Out or TV Source In connector.
	Video (Composite)	4	RCA yellow end. Plug cable into an RCA connector such as composite Video Out or TV Source In connector.
	VGA	1	15-pin, D-sub Analog. Used for HDTV or monitor.
	Optical digital audio	1	SPDIF. Used for Digital Audio Out.
	FireWire (IEEE 1394) Digital Video in/out	1 1	IEEE 1394 4-pin to 6-pin (back) IEEE 1394 4-pin to 4-pin (front)
	USB	6	USB 2.0. Used for peripheral device connectors.
	Ethernet RJ-45	1	10/100/1000. Used for broadband Internet connection.

Additional equipment

You must have the following items to set up and properly operate your system (these items are not provided with the HP Digital Entertainment Center):

- Audio system equipment such as:
 - AV receiver with speakers
 - Powered speakers
 - TV speakers
 - Monitor speakers
- Video equipment such as:
 - Monitor
 - TV
 - Video output from Cable/Satellite box or antenna

- Broadband Internet equipment such as:
 - Cable/DSL modem (working connection required for Media Center features, such as downloading the Television Program Guide)
 - Wireless LAN 802.11 b/g network
- Clean AC Power (Surge protector/line conditioner recommended)

You must purchase additional equipment and cables separately.

You may also need the following items (not included; available at electronics stores) to fully set up your HP Digital Entertainment Center, depending on your system audio and video requirements:

- Audio/Video/Network cables: See "Optional Cables not Included" on page 33.
- Audio Y adaptor(s), mini to 2 RCA (for powered speakers).

Connecting Cables

Observe the following guidelines:

- Do not plug in the HP Digital Entertainment Center until all connecting cables are installed.
- Turn off power to all other equipment before connecting cables.
- Connect cables firmly to avoid hum and noise.
- Match the color codes, for instance: yellow — video, white — left, red — right.

Connecting Audio

The HP Digital Entertainment Center supports many different audio options, sound connections, and speaker configurations.

This chapter describes the most typical, and some advanced, audio setup options for connecting audio out and audio in. To connect TV Source In audio and video, see "Connecting TV Source In" on page 73.

Your system may have different components. Speakers, AV receivers and other equipment are sold separately. Refer to the product documentation for these products.

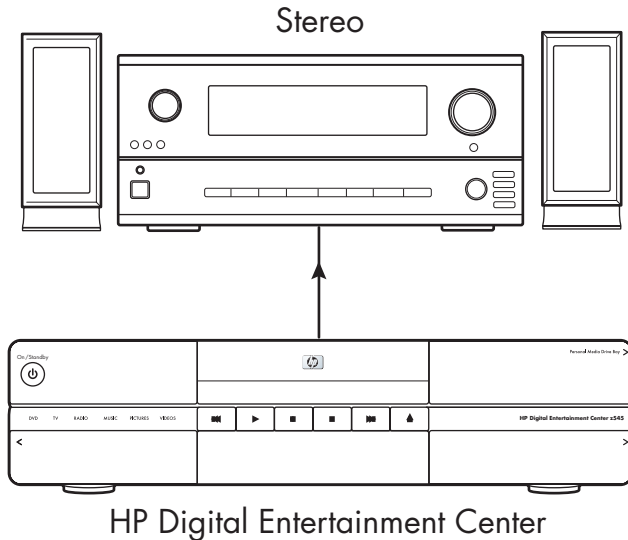





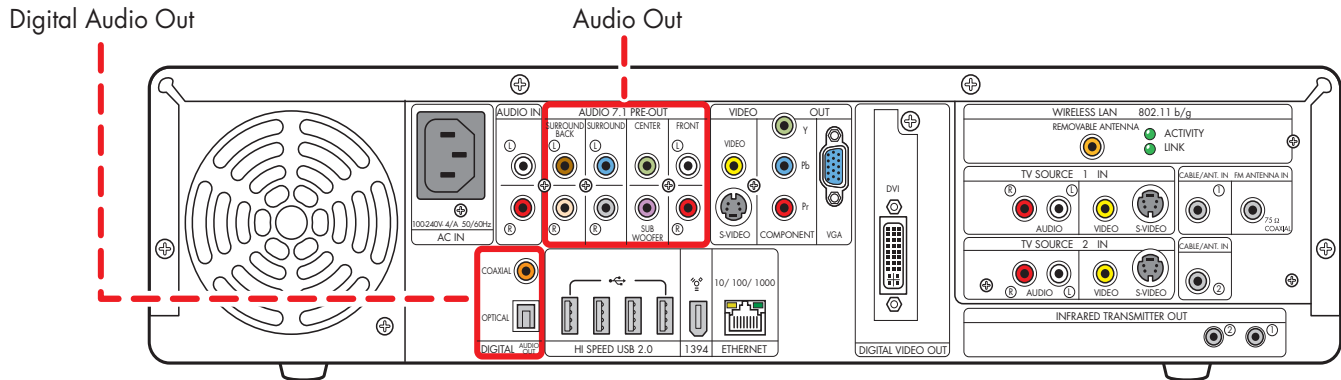

Chapter Contents:

"Audio Overview" on page 36
"Typical Audio Connection" on page 40
"TV Audio Connection" on page 41
"AV Receiver Audio Connection" on page 42
"Powered Speaker Audio Connection" on page 50
"Audio In Connections" on page 57
"FM Radio Antenna" on page 58

Audio Overview

Audio Output Connectors



Connector	Name	Color	Description
	Surround Back	Brown — Left Beige — Right	Rear speakers in a multichannel audio eight speaker system (7.1).
	Surround	Blue — Left Gray — Right	Side speakers in a multichannel audio six or eight speaker system (4.1, 5.1, 6.1, 7.1).
	Center Subwoofer	Green — Center Purple — Subwoofer	Center speaker and subwoofer in a multichannel audio system (5.1, 6.1, 7.1).
	Front	White — Left Red — Right	Stereo speakers or front speakers in a multichannel audio system (2.1, 4.1, 5.1, 6.1, 7.1).
	Digital Audio Out	Orange	Coaxial S/PDIF 5.1 only. See "Configuring Audio Output" on page 132.
	Digital Audio Out	Gray	Optical S/PDIF 5.1 only. See "Configuring Audio Output" on page 132.

Sound Connector Jacks

The audio connectors are RCA type jacks that connect from the back of your HP Digital Entertainment Center to a TV, powered speakers or an AV receiver.

The HP Digital Entertainment Center has separate Audio In connections (analog).

The HP Digital Entertainment Center has two Digital Audio Out connections (SPDIF) that are coaxial and optical. Use analog Audio 7.1 Pre-out or Digital Audio Out connectors, but not both. Use only one Digital Audio Out connector at a time.

The HP Digital Entertainment Center does not have digital audio in connections.



If your audio equipment has multiple input and output connections, then it has front panel input and output switches.

You must select the correct input and output from the audio equipment front panel or remote control to hear sound and see video.

Speaker Types

A stereo speaker set is a left-right, two-channel speaker system.

A multichannel audio speaker system has a subwoofer, left-right front and left-right surround channel, and it may include a left-right surround back channel and a center speaker. Surround back speakers are included in more advanced 7.1 systems. A subwoofer provides enhanced bass sounds.

The “.1” indicates a subwoofer. For example, 7.1 channels refer to an eight-speaker mode and uses two front speakers (left-right), two side speakers (left-right), two rear speakers (left-right), a center speaker, and a subwoofer.

See “Speaker Configurations” on page 38 for more information on speaker arrangements.

Audio amplifiers

The HP Digital Entertainment Center does not supply an amplified audio signal. You can connect the HP Digital Entertainment Center to:

- Passive speakers connected through a home audio system. A home audio system does not require active speakers because the receiver provides amplification.
- Active (powered) speakers directly. An active speaker system must have its own power cord.

Speaker Configurations

You can set up your HP Digital Entertainment Center for the following supported audio configurations:

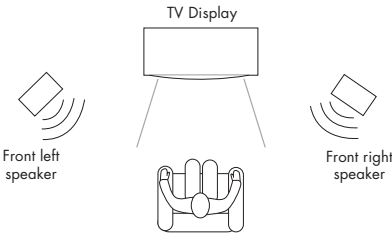
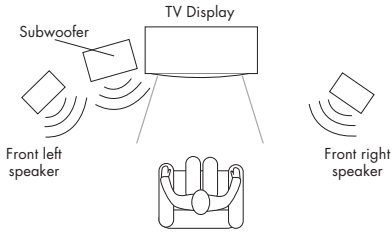
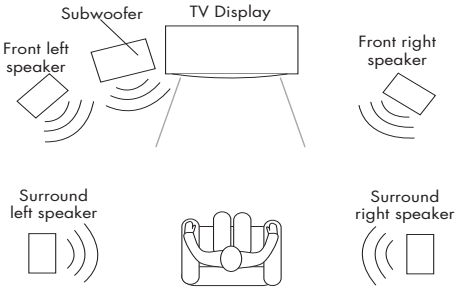
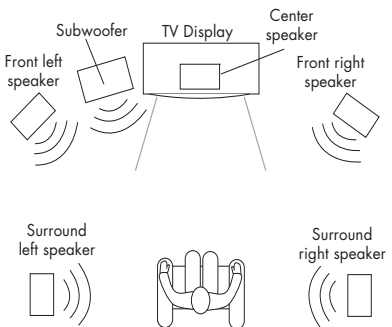
Speaker system	Home audio system description	Recommended arrangement	See:
2 (stereo)	Two speakers: Left speaker, right speaker		<p>"2.0 Home Stereo Installation" on page 43</p> <p>Or</p> <p>"2.1 Powered Speakers" on page 51</p>
2.1	Two speakers: Left speaker, right speaker One subwoofer		<p>"2.1 Home Stereo Installation" on page 44</p> <p>Or</p> <p>"2.1 Powered Speakers" on page 51</p>
4.1	Two front speakers: left speaker, right speaker Two side speakers: surround left speaker, surround right speaker One subwoofer		<p>"4.1 Home Theater Audio" on page 45</p> <p>Or</p> <p>"4.1 Powered Speakers" on page 52</p>
5.1	Two front speakers: left speaker, right speaker Two side speakers: surround left speaker, surround right speaker One center speaker One subwoofer		<p>"5.1 Home Theater Audio" on page 46</p> <p>Or</p> <p>"5.1 Powered Speakers" on page 53</p>

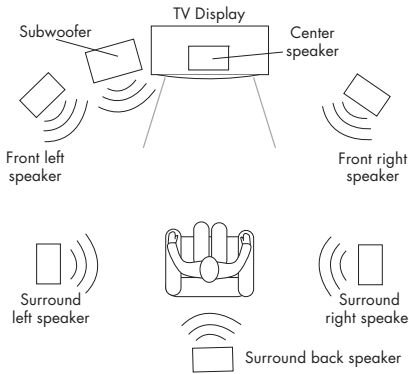
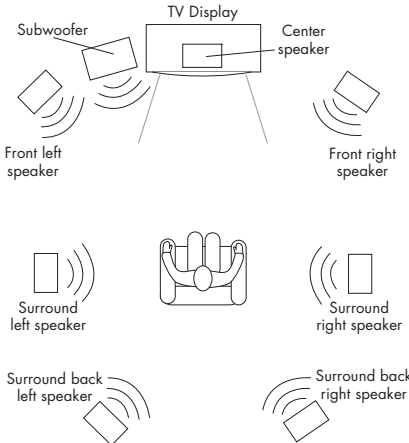
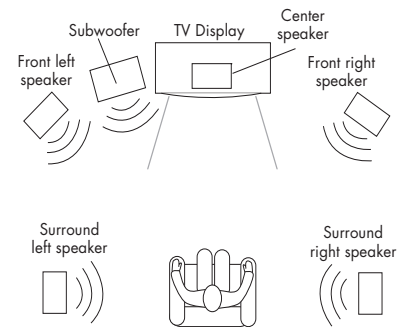
Speaker system	Home audio system description	Recommended arrangement	See:
6.1	<p>Two front speakers: left speaker, right speaker</p> <p>Two side speakers: surround left speaker, surround right speaker</p> <p>One rear surround back speaker</p> <p>One center speaker</p> <p>One subwoofer</p>		<p>If your 6.1 AV receiver has only 5.1 (6) inputs, see the following:</p> <p>“5.1 Home Theater Audio” on page 46</p> <p>Or</p> <p>“5.1 Powered Speakers” on page 53</p>
7.1	<p>Two front speakers: left speaker, right speaker</p> <p>Two side speakers: surround left speaker, surround right speaker</p> <p>Two rear speakers: surround back left speaker, surround back right speaker</p> <p>One center speaker</p> <p>One subwoofer</p>		<p>“7.1 Home Theater Audio” on page 47</p> <p>Or</p> <p>“7.1 Powered Speakers” on page 54</p> <p>If your 7.1 AV receiver has only five inputs, see “5.1 Home Theater Audio” on page 46</p>
Digital audio 5.1	<p>Digital speakers or digital input connector on the audio system</p>		<p>“Digital Home Theater Audio” on page 48</p> <p>Or</p> <p>“Digital Powered Speakers” on page 55</p>

Typical Audio Connection

Select the configuration that most closely matches your home system.

You can set up your HP Digital Entertainment Center for the following supported audio configurations:

Audio system	Description	See:
TV	TV, monitor or display direct audio connection with two speakers.	"TV Audio Connection" on page 41
AV receiver	Home stereo or home theater audio system with AV receiver and passive speakers.	"AV Receiver Audio Connection" on page 42
Powered speakers	Audio system with active speakers.	"Powered Speaker Audio Connection" on page 50
FM	FM Tuner In.	"FM Radio Antenna" on page 58
Headphones	Speakers are muted on headphone connection.	"Connecting Headphones" on page 130

Then see:

"Audio In Connections" on page 57

"Connecting Video Out" on page 59

"Configuring Audio" on page 130

TV Audio Connection

You can connect your TV, monitor or display audio directly to your HP Digital Entertainment Center for two speaker sound.

If your TV has multiple inputs, you can use your TV as a switch for audio and video.

Connecting TV Audio

To connect a TV, monitor or display audio directly:

- Connect an RCA stereo cable (white — left, red — right) from the HP Digital Entertainment Center back panel Audio Out connector to a TV audio in connector.

Refer to the *Start Here* Booklet that came with the HP Digital Entertainment Center.

For additional information on connecting the speakers, refer to the documentation that came with your speakers and AV receiver.

The following diagram shows a basic TV audio installation:

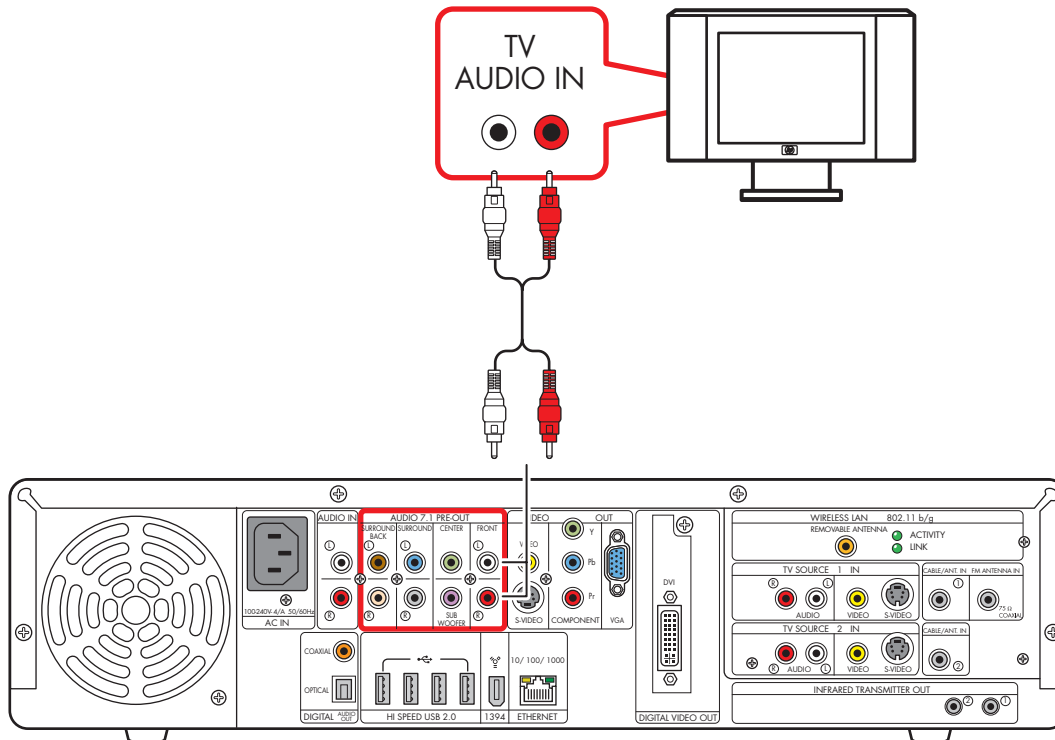

Basic TV audio setup (2.0)

AV Receiver Audio Connection

You can connect your HP Digital Entertainment Center to your home stereo or home theater multichannel AV Receivers or audio amplifiers using your existing speakers.



You can also connect video through your AV receiver or to your TV directly.

Select the configuration that most closely matches your home system, see:

"2.0 Home Stereo Installation" on page 43

"2.1 Home Stereo Installation" on page 44

"4.1 Home Theater Audio" on page 45

"5.1 Home Theater Audio" on page 46

"7.1 Home Theater Audio" on page 47

You can also use a digital connection.
See "Digital Home Theater Audio" on page 48.

AV Receiver Equipment Overview

You can connect audio and video from the HP Digital Entertainment Center, through an AV receiver, to the TV input.

Use this method to connect AV receivers or audio-only home receiver/amplifiers that have standard RCA type input connectors. **You may have to select a front panel button on your AV receiver to switch audio inputs to hear sound.**

Connecting a home stereo to an HP Digital Entertainment Center typically requires audio cables that are long enough to connect from the HP Digital Entertainment Center to the stereo or AV receiver. You may need to purchase additional cables.

2.0 Home Stereo Installation

The following diagram shows a typical two-channel (2.0) speaker installation that uses passive stereo speakers connected through a home stereo standard left and right input.

This is only a suggested configuration. Your system may be different.

Receiver/amplifier audio input connectors may be labeled CD, DVD, or DVD In.

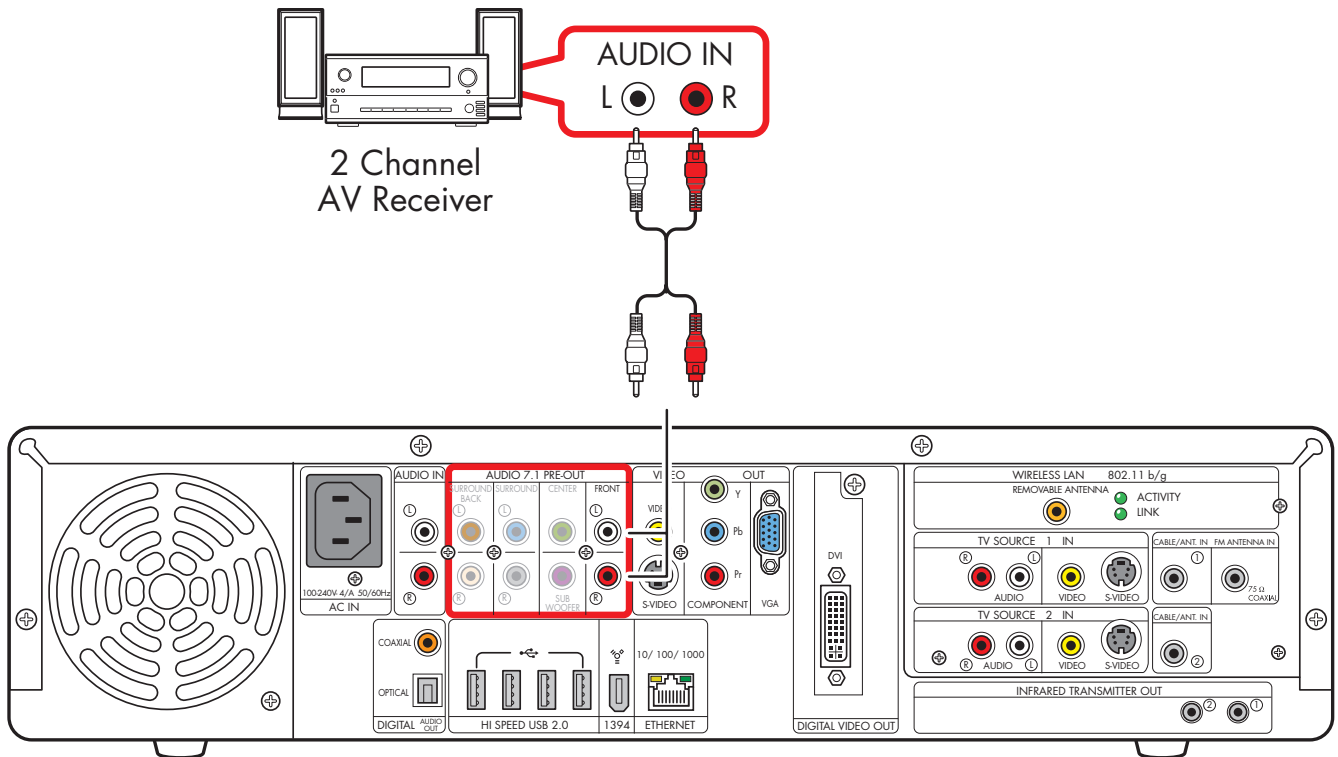

Connecting Audio

2.0 multichannel audio system connection

2.1 Home Stereo Installation

The following diagram shows a typical two-channel (2.1) speaker installation that uses passive stereo speakers connected through a home stereo standard left and right input.

This is only a suggested configuration. Your system may be different.

Receiver/amplifier audio input connectors may be labeled CD, DVD, or DVD In.

Some AV receivers generate the subwoofer output without a subwoofer input; in this case, you do not need to connect the subwoofer output from the HP Digital Entertainment Center. Refer to your AV receiver product documentation.

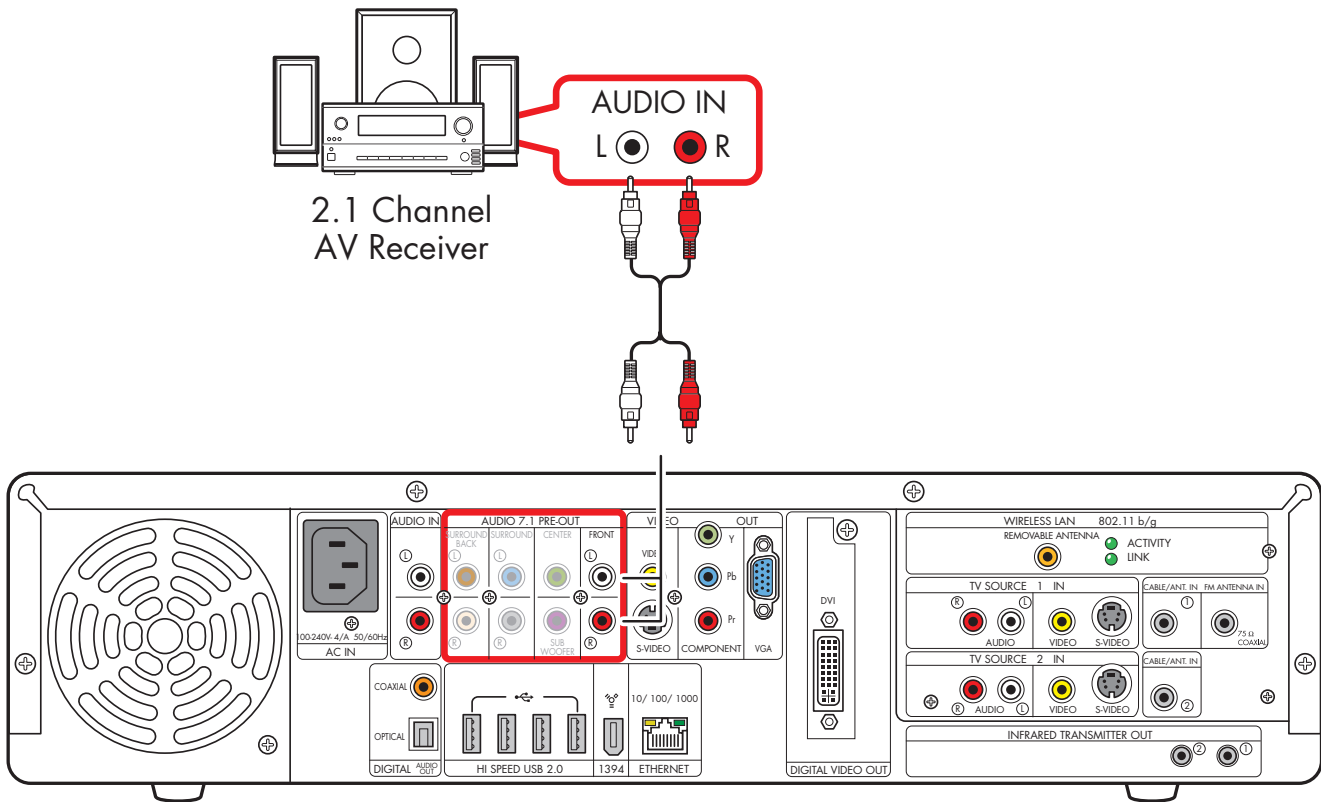

2.1 multichannel audio system connection

4.1 Home Theater Audio

The following diagram shows a typical advanced home theater audio four-channel 4/4.1 speaker installation that requires multichannel inputs on a receiver/amplifier.

This is only a suggested configuration. Your system may be different.

Receiver/amplifier audio input connectors may be labeled Surround, 4.1 or 4 Channel inputs, CD, DVD, or DVD In.

Some AV receivers generate the subwoofer output without a subwoofer input; in this case, you do not need to connect the subwoofer output from the HP Digital Entertainment Center. Refer to your AV receiver product documentation.

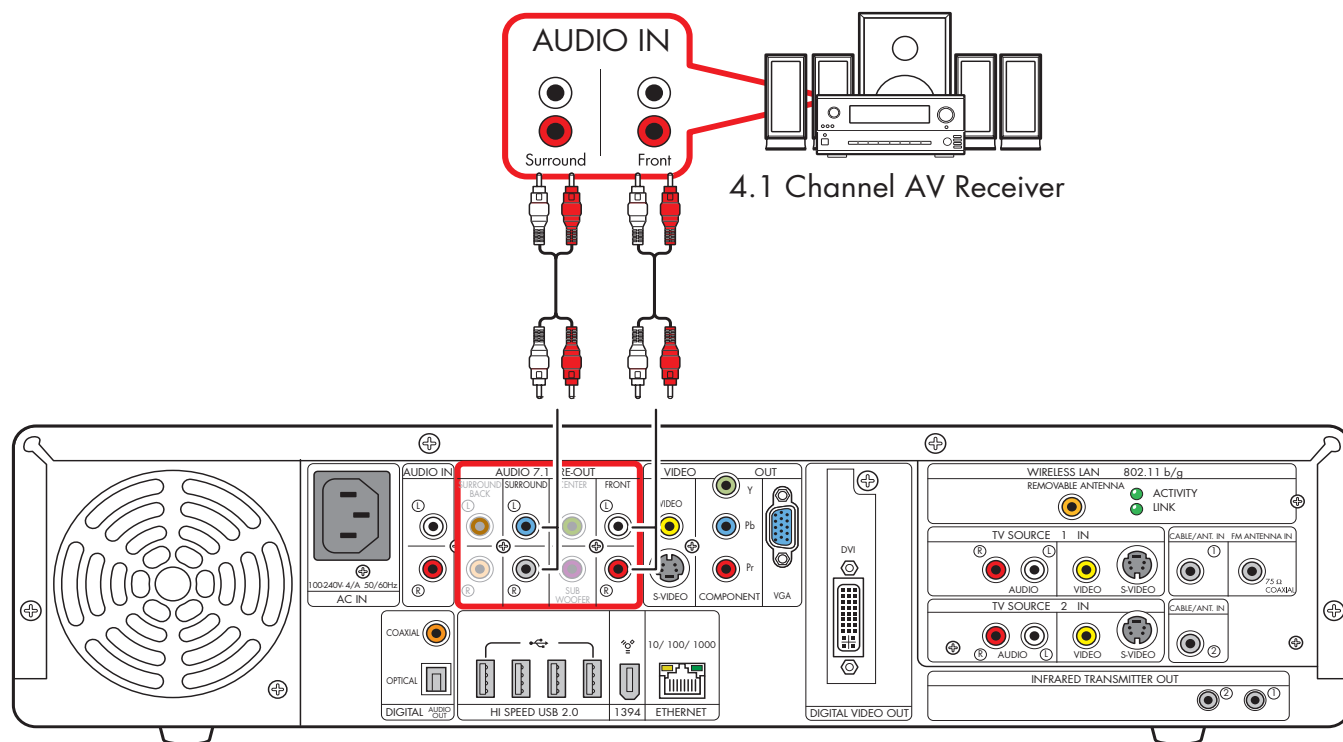

Connecting Audio

4.1 multichannel audio system connection

5.1 Home Theater Audio

The following diagram shows a typical advanced home theater audio six-channel 5.1 speaker installation that requires multichannel inputs on an AV Receiver.

This is only a suggested configuration. Your system may be different. Use this configuration for 6.1 and 7.1 AV Receivers that upmix the rear speaker(s). Refer to your AV Receiver product documentation.

AV Receiver audio input connectors may be labeled Surround, 5.1 or 6 Channel Inputs, DVD, Ext. In, or Multichannel Inputs.

Both Media Center speaker settings and DVD audio settings must be changed for proper audio setup. Go to "Configuring Audio Output" on page 132 and note your speaker configuration choice for later software setup steps.

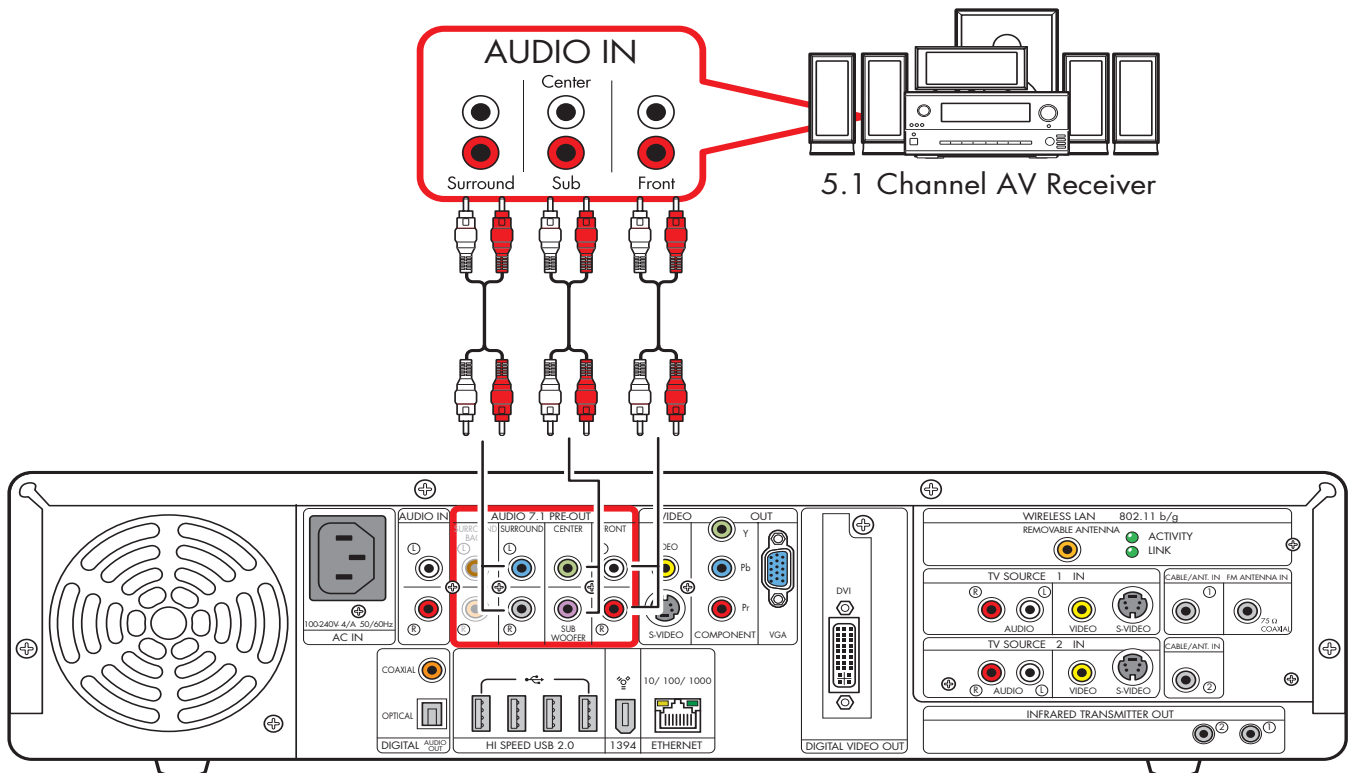

5.1 multichannel audio system connection

7.1 Home Theater Audio

The following diagram shows a typical advanced home theater audio eight-channel 7.1 speaker installation that requires multichannel inputs on an AV Receiver.

This is only a suggested configuration. Your system may be different. If your AV receiver supports 7.1 and has only 5.1 inputs, see "5.1 Home Theater Audio" on page 46.

AV Receiver audio input connectors may be labeled Surround, 7.1 or 8 Channel inputs, DVD, Ext. In, or Multichannel Inputs.



Some AV receivers can generate (upmix) the 7.1 audio with 5.1 channels. Refer to your AV receiver product documentation.



Both Media Center speaker settings and DVD audio settings must be changed for proper audio setup. Go to "Configuring Audio Output" on page 132 and note your speaker configuration choice for later software setup steps.

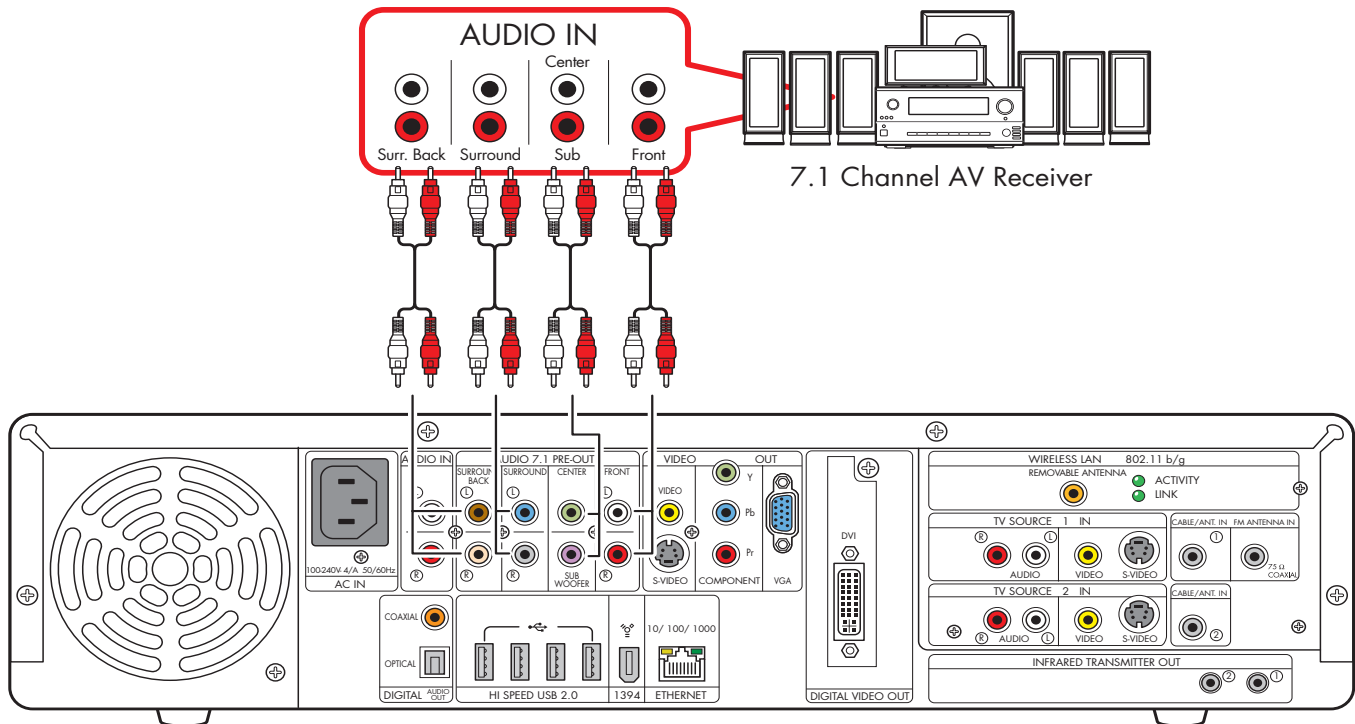

7.1 multichannel audio system connection

Digital Home Theater Audio

The HP Digital Entertainment Center supports digital audio output.

- For TV and music: two-channel stereo. (Your AV receiver may separate the audio signal into multiple channels.)
- For DVD playback: the multiple channel Dolby Digital 5.1 or DTS Digital encoded audio signal passes to your AV receiver for decoding. Refer to your AV receiver product documentation.

You can connect the either coaxial or optical digital audio cable, depending on your system. If you have both cables, connect only one cable. Do not connect analog multichannel speaker outputs if you connect the digital output.

- Insert optical cords straight in until they click into place.
- Do not bend or tie optical cords.

To connect digital audio from your HP Digital Entertainment Center to an AV receiver:

- 1 Connect the Digital Out connector on the back panel of your HP Digital Entertainment Center, to the Digital Input (SPDIF) on your AV receiver or digital audio system.
- 2 Select the AV receiver input.
- 3 Use the AV receiver to adjust the volume.

The following diagram shows a typical advanced home theater audio six-channel 5.1 speaker installation that requires a digital input on an AV Receiver. This is only a suggested configuration. Your system may be different, such as having more speakers.



Both Media Center speaker settings and DVD audio settings must be changed for proper audio setup. Go to “Configuring Audio Output” on page 132 and note your speaker configuration choice for later software setup steps.



Some AV receivers can generate (upmix) the 7.1 audio with 5.1 channels. Refer to your AV receiver product documentation.

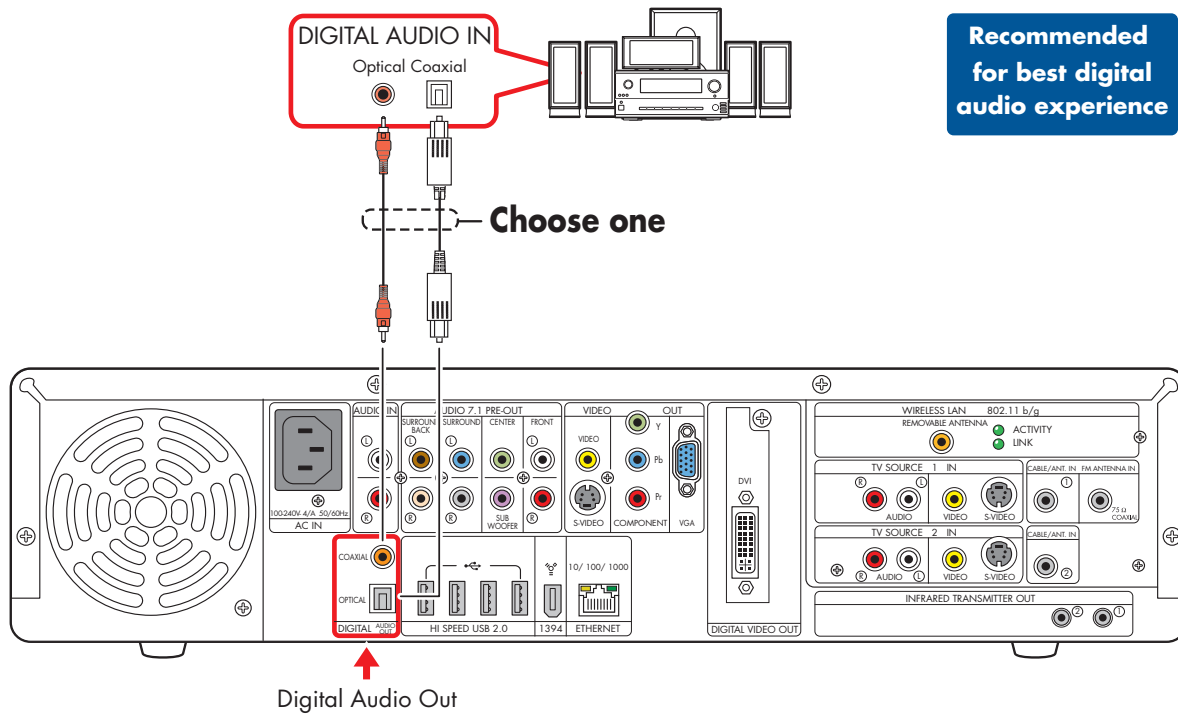

Digital 5.1 multichannel audio system connection

Powered Speaker Audio Connection

You can connect active (powered) speakers directly to your HP Digital Entertainment Center. An active speaker system must have its own power cord.

You may need Y adapter cables.

Select the configuration that most closely matches your home system, see:

"2.1 Powered Speakers" on page 51

"4.1 Powered Speakers" on page 52

"5.1 Powered Speakers" on page 53

"7.1 Powered Speakers" on page 54

You can also use a digital connection. See "Digital Powered Speakers" on page 55.

Y adapter cables

The HP Digital Entertainment Center has RCA type output connectors. You may need to connect Y adapter cables between your HP Digital Entertainment Center analog audio output and your powered speaker inputs. You can also use them for audio inputs depending on your equipment.

Use Y adapter cables with one female 1/8-inch (3.5 mm) stereo mini-jack on one end and two male RCA connectors on the other end. These cables are not provided.

The number of Y adapter cables you need to connect to your home stereo system depends on the number of speakers you install.

Select the cable that most closely matches your home system:

2.1 speaker system: 1 Y adapter cable

4.1 speaker system: 2 Y adapter cables

5.1 speaker system: 3 Y adapter cables

7.1 speaker system: 4 Y adapter cables



Y adapter cables and extension cables are purchased separately.

2.1 Powered Speakers

To connect simple left/right stereo (2.0) active speakers:

Or

To connect two speakers and a subwoofer for 2.1 speaker output:

- 1 Connect the RCA connector end of the Y adapter cable to the Front Right and Front Left Audio Out connectors on the back of your HP Digital Entertainment Center.
- 2 Connect the female 1/8-inch (3.5 mm) mini-jack end of the Y adapter cable to the audio line in cable of the speaker amplifier.
- 3 Plug in the speaker system power. Refer to the speaker documentation.
- 4 Turn on the speaker system.

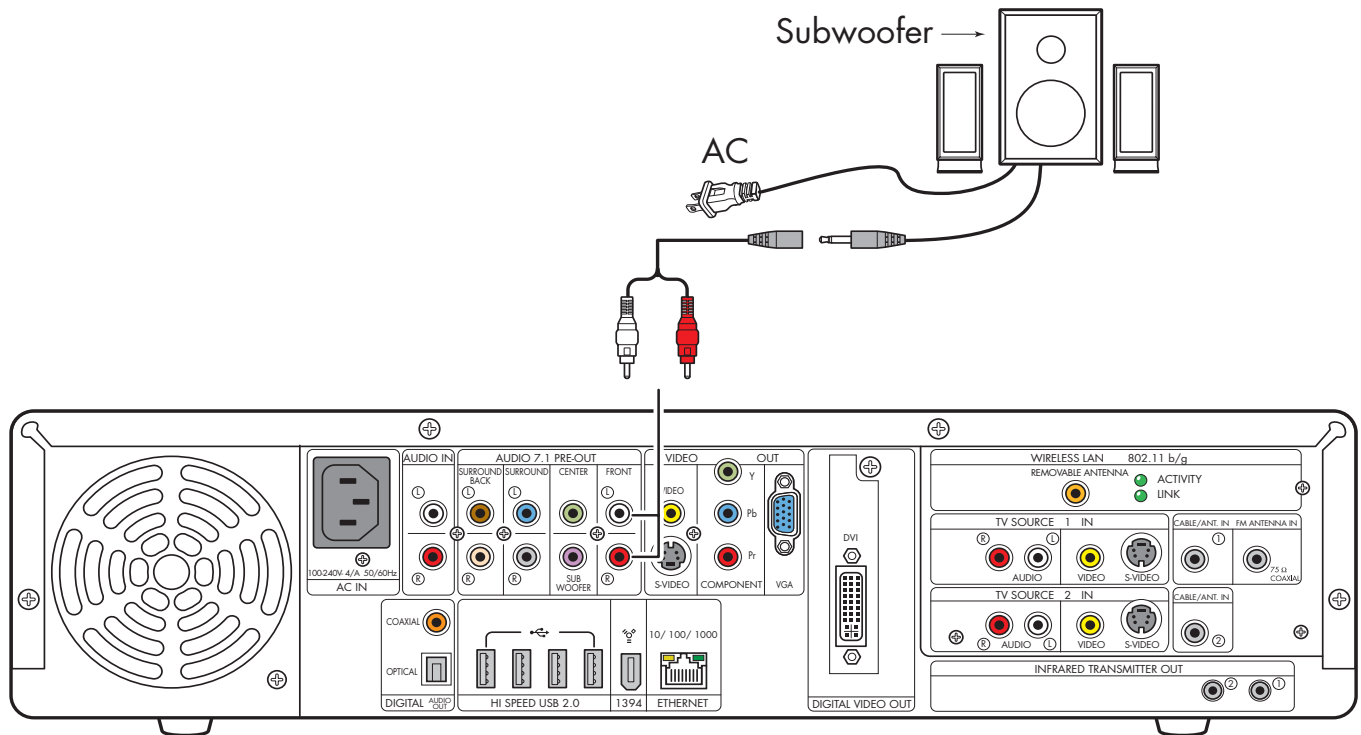

2.1 powered speaker installation

4.1 Powered Speakers

To connect two front speakers, two surround speakers, and a subwoofer for four-channel (4.1 speaker) output:

- 1 Connect the RCA connector end of the Y adapter cables to the Audio Out connectors Front Right, Front Left, Surround Right, Surround Left on the back of your HP Digital Entertainment Center.
- 2 Connect the female 1/8-inch (3.5 mm) mini-jack end of the Y adapters to the audio line in cables of the speaker amplifier.
- 3 Plug in the speaker system power. Refer to the speaker documentation.
- 4 Turn on the speaker system.

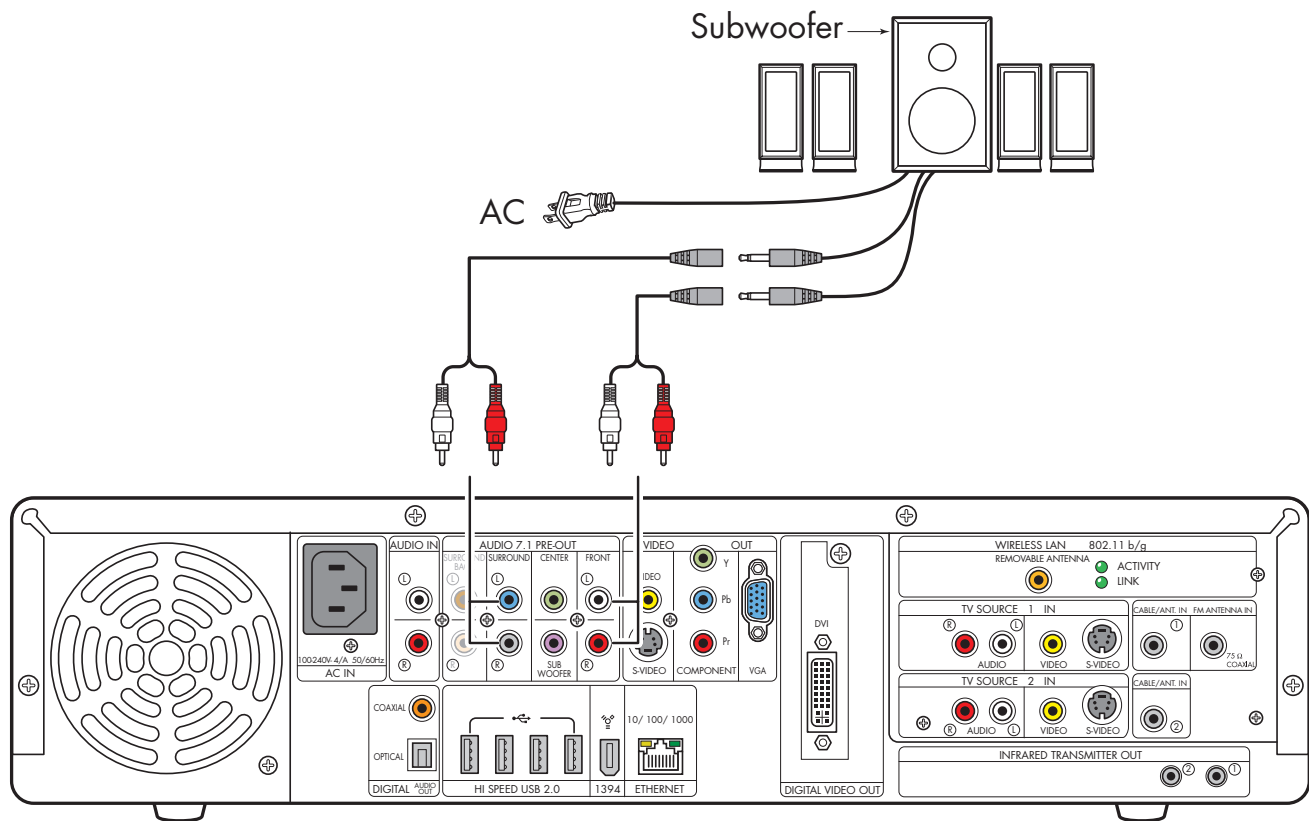

4.1 powered speaker installation

5.1 Powered Speakers

To connect two front speakers, two surround speakers, a center speaker, and a subwoofer for six-channel (5.1 speaker) output:

- 1 Connect the RCA connector end of the Y adapter cables to the Audio Out connectors Front Right, Front Left, Surround Right, Surround Left, Center on the back of your HP Digital Entertainment Center.
- 2 Connect the female 1/8-inch (3.5 mm) mini-jack end of the Y adapters to the audio line in cables of the speaker amplifier.
- 3 Plug in the speaker system power. Refer to the speaker documentation.
- 4 Turn on the speaker system.

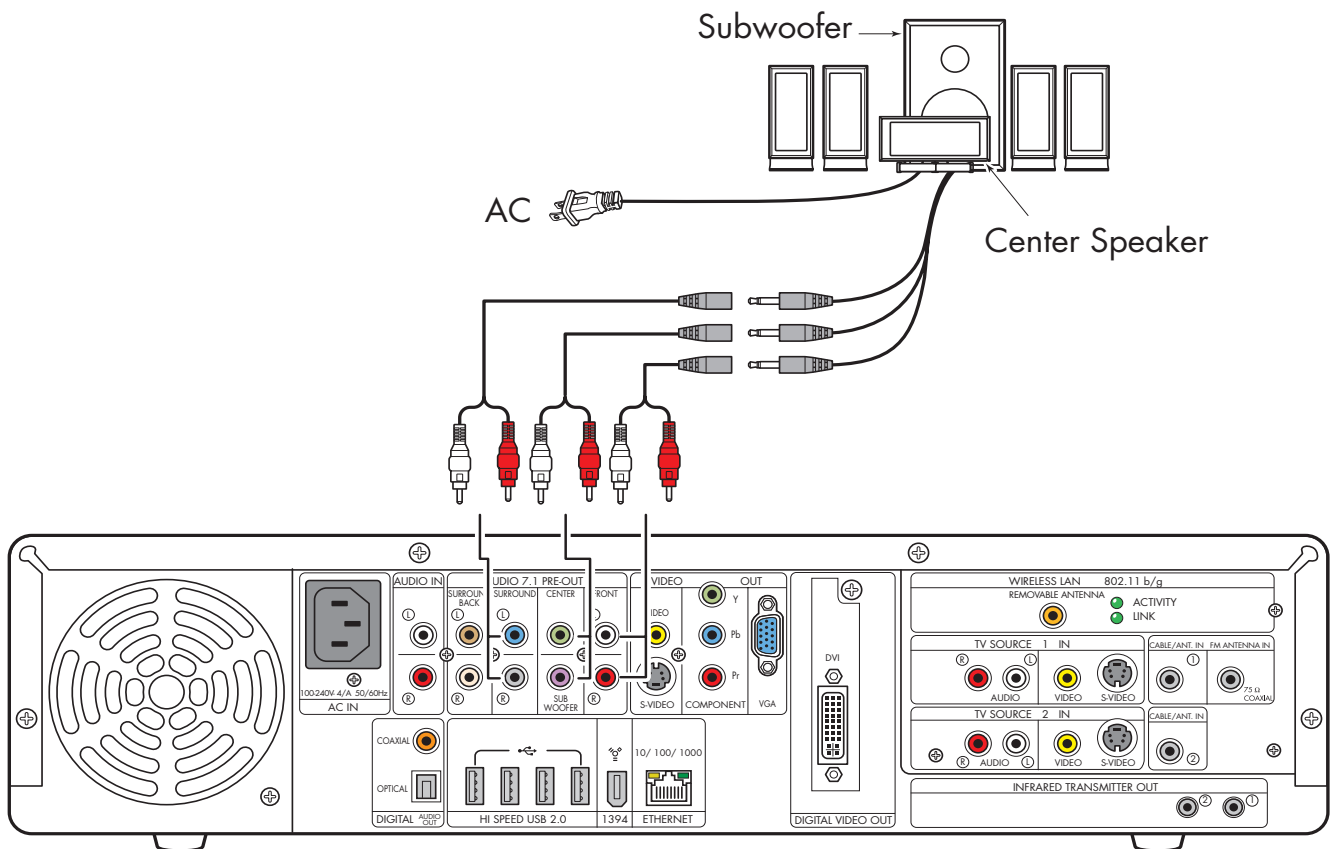

Typical 5.1 powered speaker installation

7.1 Powered Speakers

You can install a 7.1 audio system to your HP Digital Entertainment Center.

To connect two front speakers, two surround speakers, two surround back speakers, a center speaker, and a subwoofer for eight-channel (7.1 speaker) output:

- 1 Connect the RCA connector end of the Y adapter cables to the Audio Out connectors Front Right, Front Left, Center, Surround Right, Surround Left, Surround Back on the back of your HP Digital Entertainment Center.
- 2 Connect the female 1/8-inch (3.5 mm) mini-jack end of the Y adapters to the audio line in cables of the speaker amplifier.

3 Plug in the speaker system power. Refer to the speaker documentation.

4 Turn on the speaker system.



Some powered speakers can generate (upmix) the 7.1 audio with 5.1 input channels. Refer to your product documentation.

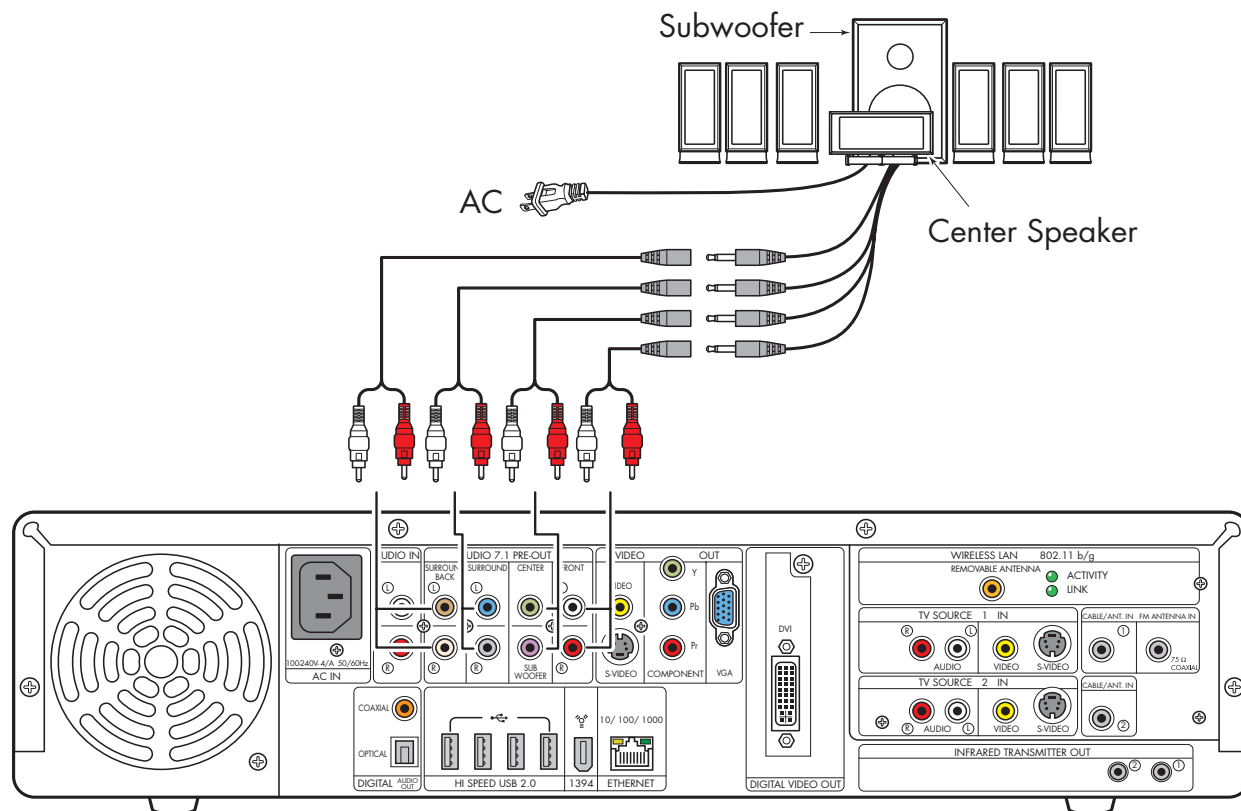

Typical 7.1 powered speaker installation

54 HP Digital Entertainment Center

Digital Powered Speakers

You can install a digital audio system with up to two front speakers, two surround speakers, two surround back speakers, a center speaker, and a subwoofer to your HP Digital Entertainment Center.

Do not connect analog multichannel speaker outputs if you connect the digital output.

You can connect either the coaxial or optical digital audio cable, depending on your system. If you have both cables, connect one cable only.

- Insert optical cords straight in until they click into place.
- Do not bend or tie optical cords.

To connect six-channel (5.1 speaker) digital output to a speaker digital input:

- 1 Connect a digital audio coaxial or optical cable to a Digital Audio Out connector on the back of your HP Digital Entertainment Center.
- 2 Connect the digital audio coaxial or optical cable to the speakers.
- 3 Plug in the speaker system power. Refer to the speaker documentation.
- 4 Turn on the speaker system.

Some powered speakers can generate (upmix) the 7.1 audio with 5.1 input channels. Refer to your product documentation.

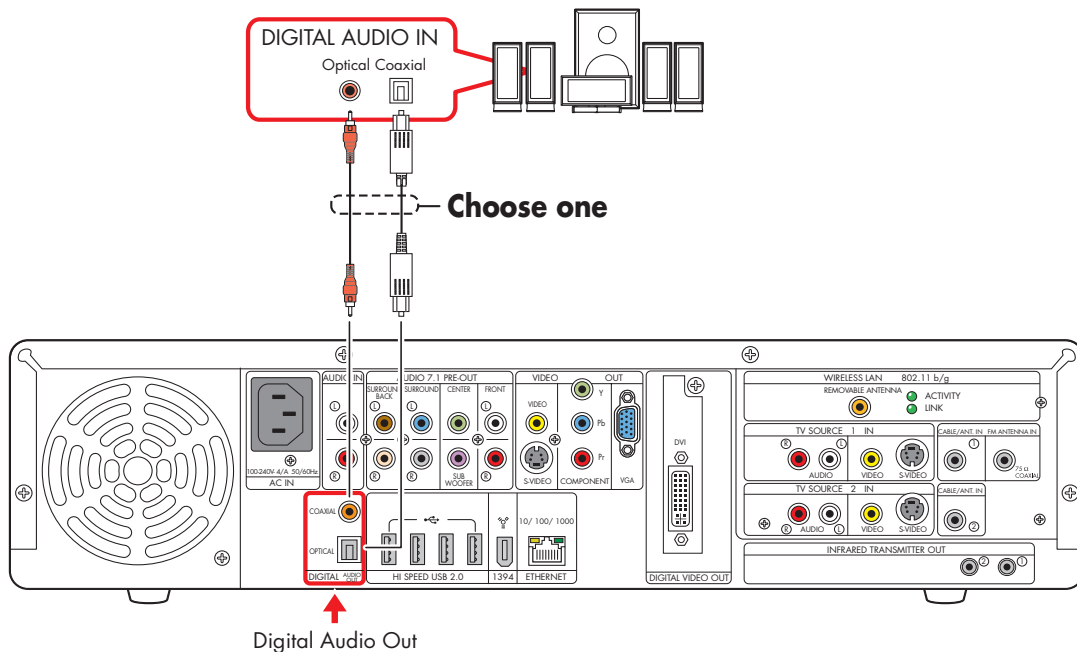

Digital powered speaker installation (5.1 shown)

Monitor Speakers

You can connect powered monitor speakers directly to your HP Digital Entertainment Center.

You may need Y adapter cables.

You can:

- Connect simple left/right stereo 2.0 powered monitor speakers.

Or

- Connect two powered speakers and a subwoofer for 2.1 monitor speaker output.



Monitor speaker configurations and connections may vary. Your system may be different.

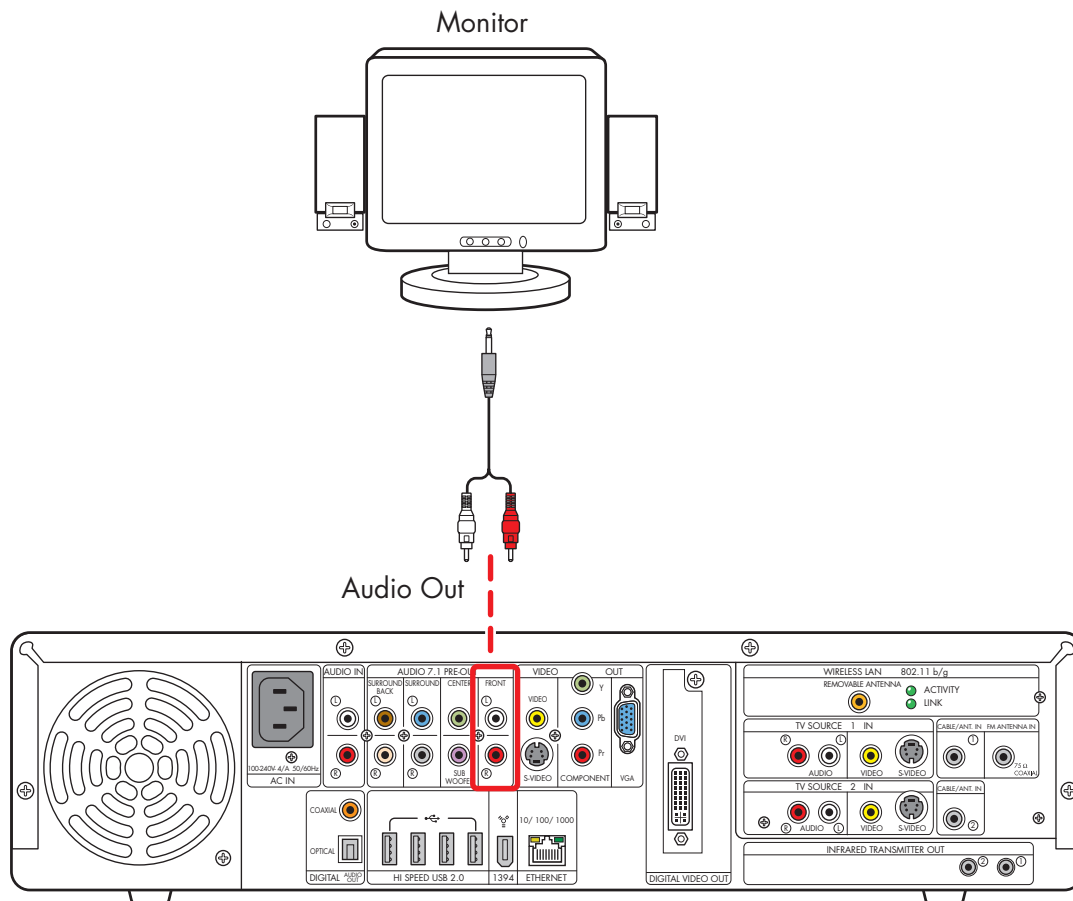

Monitor speaker installation (2.0 shown)

Audio In Connections

You can connect your existing home stereo or home theater audio equipment, such as a tape player or turntable, to your HP Digital Entertainment Center using the Audio In stereo connectors on the back panel.

The Audio In connection can be used in conjunction with sound recording software (application software not provided) to record audio from other external equipment.

The following diagram shows a typical Audio In stereo connection. This is only a suggested configuration. Your system may be different.

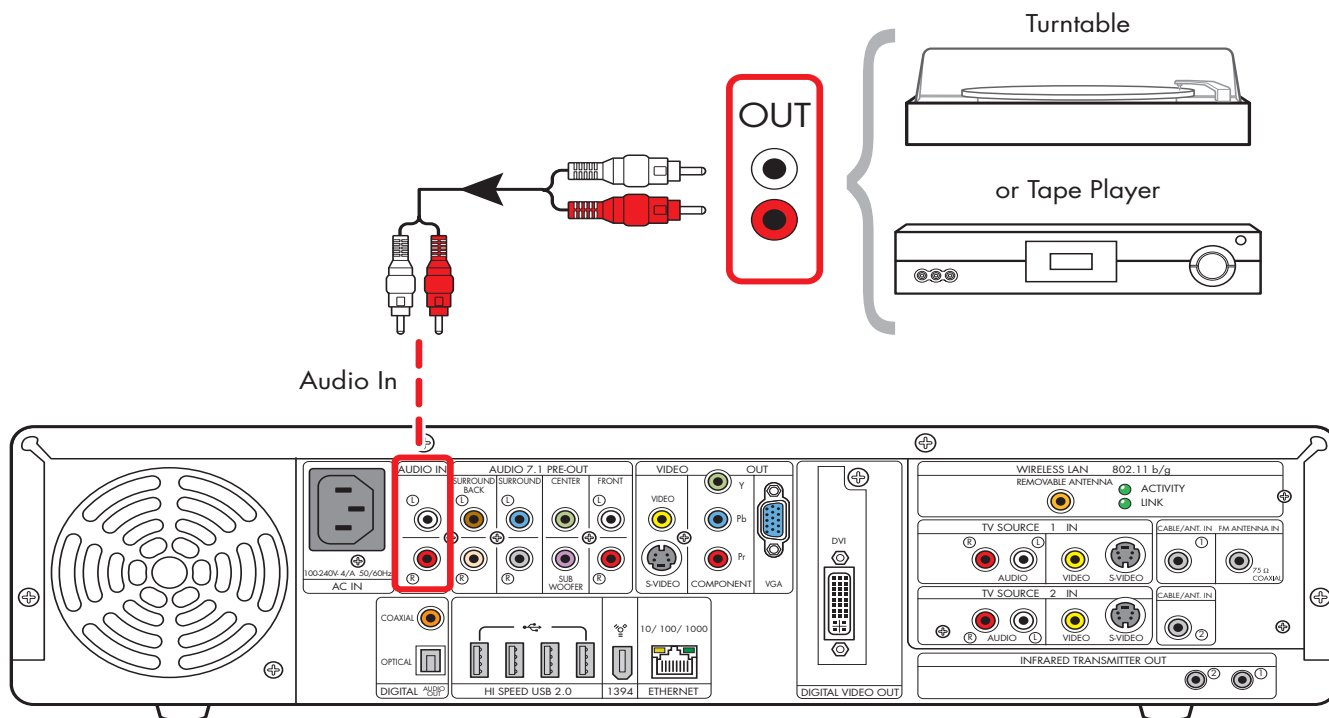

Audio In stereo connection



A turntable might require special phono inputs through a mixer.

FM Radio Antenna

The HP Digital Entertainment Center includes an FM radio tuner.

To connect the FM radio antenna:

- 1 Plug the FM radio antenna cable into the FM (Tuner) In connector on the back panel (75-Ohm Coaxial).
- 2 You may want to extend the ends of the cable to improve your FM radio signal reception.

The following diagram shows a typical FM antenna indoor connection. This is only a suggested configuration. Your system may be different.

The following diagram shows a typical FM antenna rooftop connection.

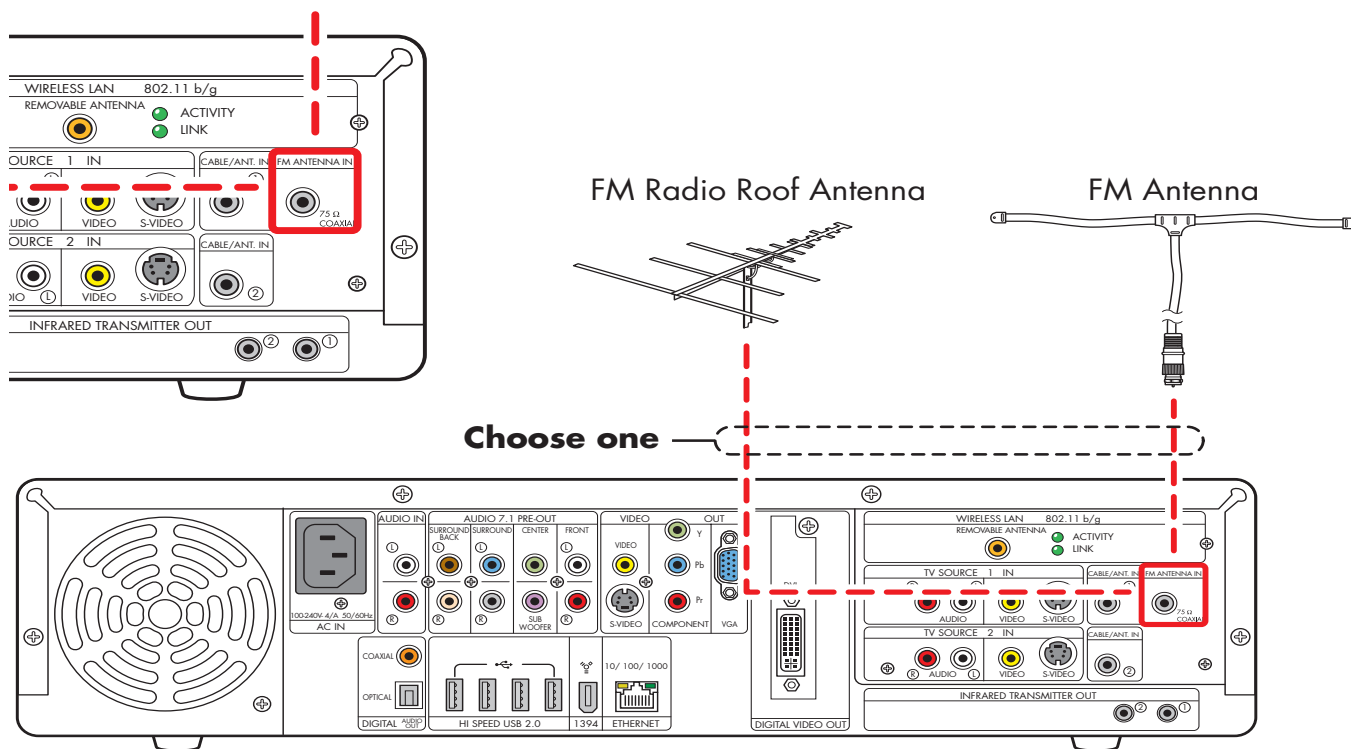

FM radio antenna cable external or internal connection

Connecting Video Out

This chapter describes how to connect the HP Digital Entertainment Center to a TV or display monitor, so you can watch TV and view the screen. It includes the most typical, and some advanced, video output options.

You must have a display such as a TV or monitor connected to the HP Digital Entertainment Center for proper operation. HP Digital Entertainment Centers support many different video options, connections, and configurations of TVs and monitors. Your system may have different equipment.

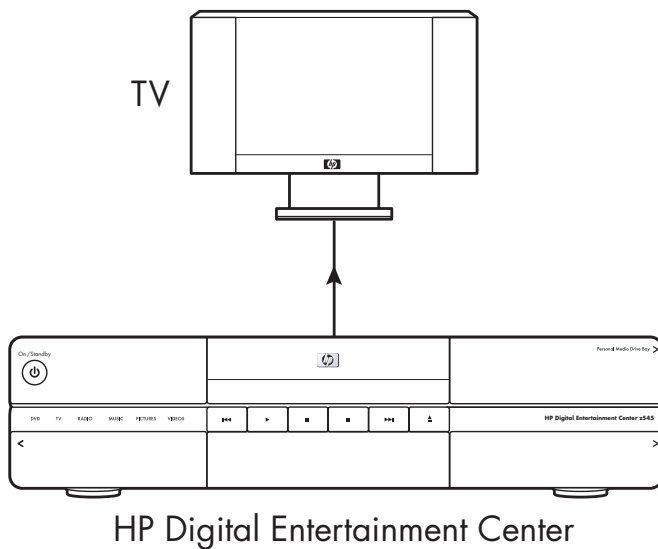

Chapter Contents:

"Video Out Overview" on page 60
"Typical Video Out Connections" on page 65
"Video Out to TV" on page 66
"Video Out from AV Receiver to TV" on page 68
"Video Out to Monitor" on page 70
"Video Out to TV and Monitor" on page 71

Video Out Overview

Video Out Connection Overview

The back panel connector that you hook up to your TV is labeled Video Out. For a standard television, choose one of the following Video Out connectors and corresponding cables:

- Video (composite)
- S-video
- Component (Y, Pb, Pr)



For a “high definition” plasma, LCD, or HDTV display or monitor, choose one of the following Video Out connectors and cables:

- VGA
- DVI



Component video output requires specific configurations for certain display types and resolutions. Go to your model number page at <http://www.hp.com/support> for instructions on using component video.

The type of video cable you need depends on your TV:

- If your TV has a composite video jack, you may need a composite video cable.
- If your TV has an S-video jack, you need an S-video cable. An S-video cable provides separate color and black-and-white image signals, and delivers a sharper image than a composite video cable does.
- For component video, see “Component Video Settings” on page 62.

To connect a TV to the HP Digital Entertainment Center, you may need a video cable and an audio cable. Use a video cable to connect the Video Out on the HP Digital Entertainment Center to your TV Video In. These cables are included in the box. You may need other or additional cables, depending on your TV or monitor.





When using an AV receiver, the Video Out cables can be connected directly to a TV and just the audio is connected and switched through an AV receiver, or video and audio is connected and switched through an AV receiver.

When using an AV receiver, do not switch video types such as connecting a Component In to a Composite Out. Not all AV receivers support signal conversion.

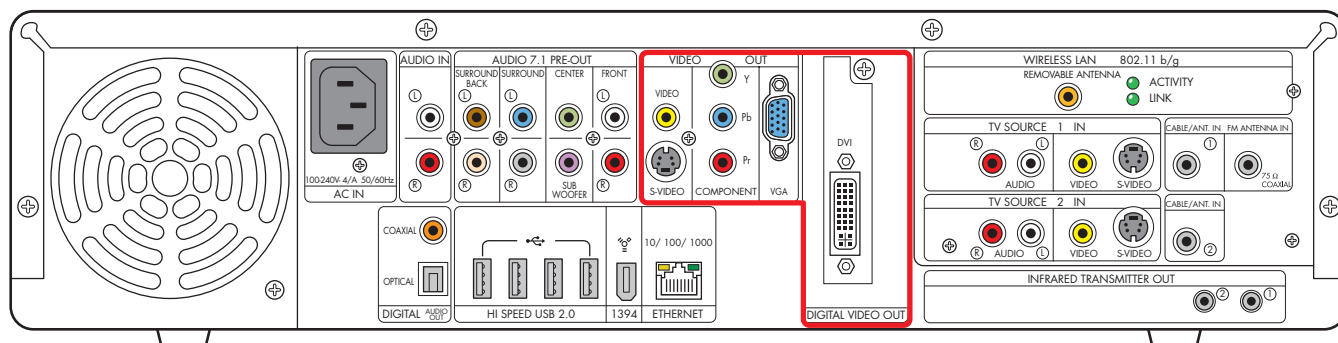
Video Output Connectors

Location and number of connectors may vary by model.

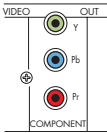

Item	Connector	Type	Color
	Video (composite) Video Out	RCA jack	Yellow
	S-video Out	Y/C video 4-pin	Black
	Component Video Out (interlaced or progressive scan) See http://www.hp.com for configuration options.	3 RCA jacks	Green: Y Blue: Pb Red: Pr
	VGA Video Out	Analog: 15-pin D-sub Video Out	Blue

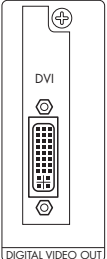
Item	Connector	Type	Color
	Digital: DVI Video Out	Digital: 29-pin D-sub DVH Or Analog: Video Out	White

Component Video Settings

You must configure settings to view component video on your TV properly. Go to your model number page at <http://www.hp.com/support> for instructions on using component video.



HP recommends initial setup using VGA or composite video.

Overview

You must change the default desktop resolution of 800 x 600 to 640 x 480 for the best DVD playback and Media Center experience. A resolution of 800 x 600 is best for Windows desktop dialog boxes. See "Adjusting the Desktop Display" on page 137. The component video default output is 480i (interlaced) to provide a picture on most TVs. Driver adjustments are required to configure progressive scan for TVs that support progressive scan.

Progressive scan format provides a better desktop viewing experience than interlaced format.

Content-protected DVD playback is limited to the following when component video is connected:

Component Format	Desktop Resolution
480i (interlaced)	640 x 480 @ 30 Hz
480p (progressive)	640 x 480 @ 60 Hz

TV Display Overview

The HP Digital Entertainment Center allows you to connect to a TV to view the monitor image on a TV screen. With the TV connected, you can view the HP Digital Entertainment Center image, watch TV or DVD movies, or play games on your TV. See "Video Out to TV and Monitor" on page 71.

You must manually set up dual displays. Only either the TV or monitor, not both, will display after initial power up. See "Configuring Video Output" on page 134.

Audio and Video Switching Overview

AV receiver: You can use your AV receiver as a switch to direct the video to your TV and the audio to your speakers from the HP Digital Entertainment Center. This method gives you the best audio quality, and is easy to switch audio/video inputs through your AV receiver remote.

If your AV receiver has multiple input and output connections, then it has front panel input and output switches.

You must select the correct input and output on the AV receiver front panel or remote control to hear sound and see video.

TV: If you have multiple audio/video inputs on your TV, you can use your TV as an audio/video switch and control inputs through your TV remote.

If your TV has multiple input connections, then it has a front panel input switch.

You must select the correct input and output on the TV front panel or remote control to hear sound and see video.

Monitor: If you have multiple audio/video inputs on your monitor, you can use your monitor as an audio/video switch. You will probably not be able to use a remote control to switch.

If your monitor has multiple input and output connections, then it has a front panel input switch and output switch.

You must select the correct input and output on the monitor front panel to hear sound and see video.



If your video equipment has multiple input and output connections, then it has front panel input and output switches.

You must select the correct input and output from the video equipment front panel or remote control to hear sound and see video.

Using the Remote Control with Your TV

You can use the HP Digital Entertainment Center remote control to change channels and adjust volume if you have a cable box or satellite receiver, have installed the Infrared Transmitter cable, and have configured the remote control after initial power up.

Always point the HP Digital Entertainment Center remote control at the HP Digital Entertainment Center front panel. The infrared remote sensor, behind the front panel window, receives signals from the remote control.

The HP Digital Entertainment Center includes one or two Infrared Transmitter cables (IR blaster) that are required to control one or two set-top-boxes. You must carefully position the Infrared Transmitter cable tip on the set-top-box to ensure the set-top-box receives the IR signal from the HP Digital Entertainment Center. See "Infrared Transmitter Connection" on page 88.

Typical Video Out Connections

This section describes how to hook up the Video Out connectors on the back panel of the HP Digital Entertainment Center into your home system so you can watch TV.

These are only suggested configurations. Your system may be different. Select the configuration that most closely matches your home system.

You may set up your HP Digital Entertainment Center for the following supported configurations:

Display/video configuration	See:
Video Out from HP Digital Entertainment Center to TV, through a direct connection	"Video Out to TV" on page 66
Video Out from HP Digital Entertainment Center, through an AV receiver, to a TV	"Video Out from AV Receiver to TV" on page 68
Video Out from HP Digital Entertainment Center to a monitor, through a direct connection	"Video Out to Monitor" on page 70
TV and Monitor from HP Digital Entertainment Center, dual display option (You must manually set dual displays.)	"Video Out to TV and Monitor" on page 71
Other Video Equipment	"Connecting Video Equipment" on page 95

Then see:
"Connecting TV Source In" on page 73
"Connecting Video Equipment" on page 95
"Configuring Video" on page 134

Video Out to TV

Switching: If you have multiple audio/video inputs on your TV, you can use your TV as an audio/video switch and control inputs through your TV remote.

Connectors: For a standard television, choose one of the following Video Out connectors and cables:

- Video (composite)
- S-video
- Component (Y, Pb, Pr)



For a plasma, LCD, or HDTV display, choose one of the following Video Out connectors and cables:

- VGA
- DVI



Equipment: The TV and some cables are not included with the HP Digital Entertainment Center. Refer to the documentation that came with your TV/display. You can also connect a video projector using this procedure.

Configuration: You can adjust the TV display, after initial turn on, using the Media Center software. See "Initial Configuration" on page 121.

Procedure: Connect a video cable from the HP Digital Entertainment Center back panel Video Out directly to the TV Video In.



Component video output requires specific configurations for certain display types and resolutions. Go to your model number page at <http://www.hp.com/support> for instructions on using component video.



If the Video Out S-video and composite connections are not connected to a TV or video input when the HP Digital Entertainment Center is turned on, the S-video and composite jacks turn off automatically and you see no picture.

You must restart; press and hold down the power button for four seconds to restart your HP Digital Entertainment Center to ensure Video Out connection to your TV or AV receiver.

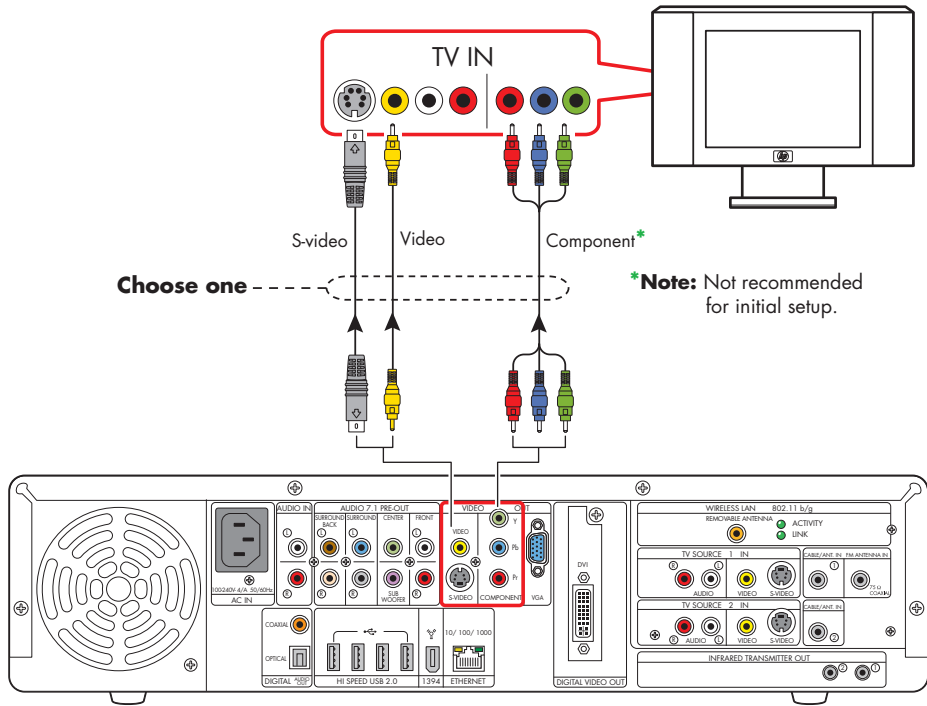

TV Out (standard)

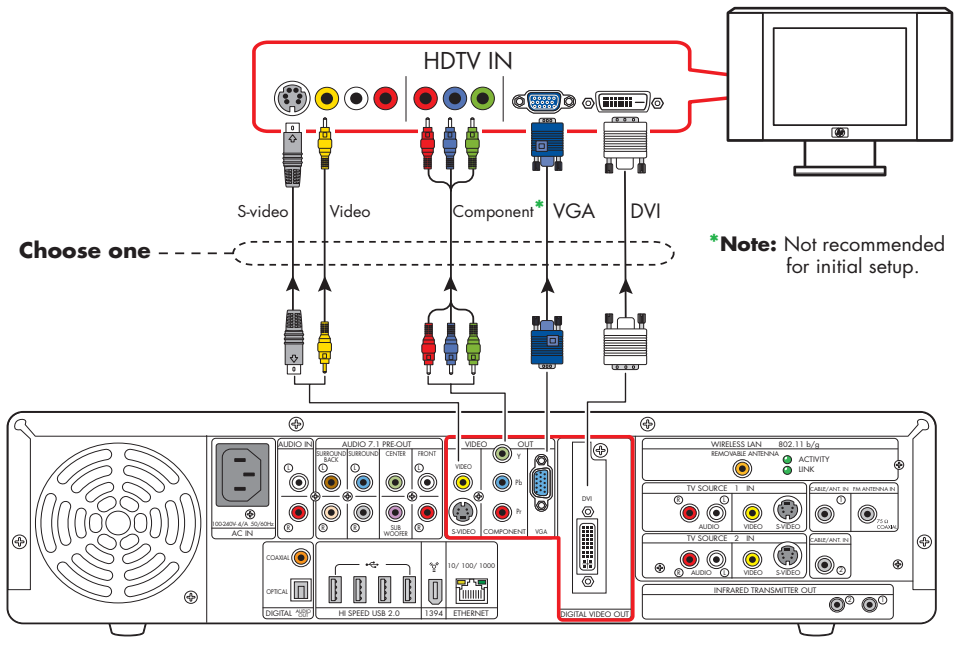

TV Out (high definition)

Video Out from AV Receiver to TV

Switching: Switch audio and video through your AV receiver if your AV receiver switches video and has the correct connections. This method gives you the best audio quality, and you can easily switch audio/video inputs through your AV receiver remote.

Connectors: For a standard television, choose one of the following Video Out connectors and cables:

- Video (composite)
- S-video
- Component (Y, Pb, Pr)



For a plasma, LCD, or HDTV display, choose one of the following Video Out connectors and cables:

- VGA
- DVI



Equipment: The TV, AV receiver, and some cables are not included with the HP Digital Entertainment Center. See the documentation that came with your TV and AV receiver.

Configuration: You can adjust the TV display, after initial turn-on, using the Media Center software settings. See "Initial Configuration" on page 121.

Procedure:

- 1 Connect a video cable from the HP Digital Entertainment Center back panel Video Out to the AV receiver Video In.
- 2 Connect a video cable from the AV receiver Video Out to the TV Video In.
Use the same connector type if your AV receiver does not support cross connecting.



If the Video Out S-video and composite connections are not connected to a TV or video input when the HP Digital Entertainment Center is turned on, the S-video and composite jacks will turn off automatically.

You must restart; press and hold down the power button for four seconds to restart your HP Digital Entertainment Center to ensure Video Out connection to your TV or AV receiver.

If your TV and AV receiver has multiple input and output connections, then it has front panel input and output switches.

You must select the correct input and output from the TV and AV receiver front panel or remote control to hear sound and see video.

Component video output requires specific configurations for certain display types and resolutions. Go to your model number page at <http://www.hp.com/support> for instructions on using component video.

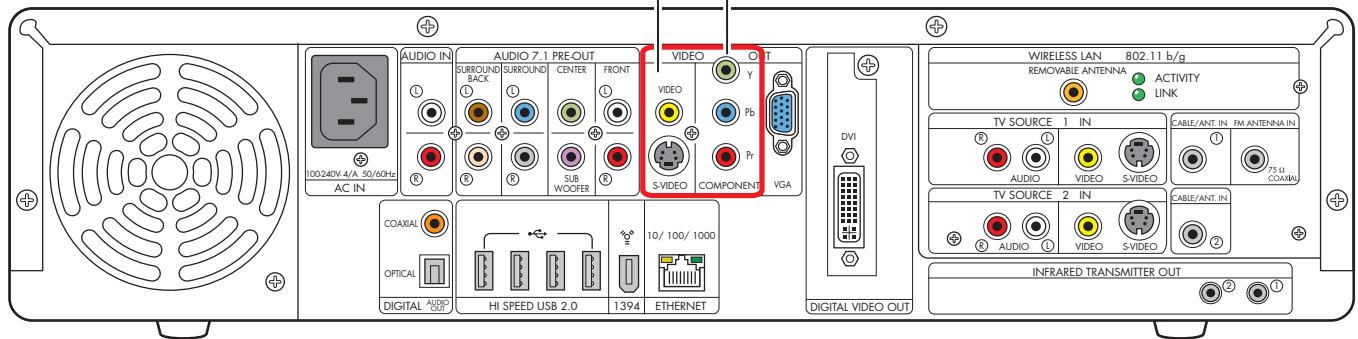
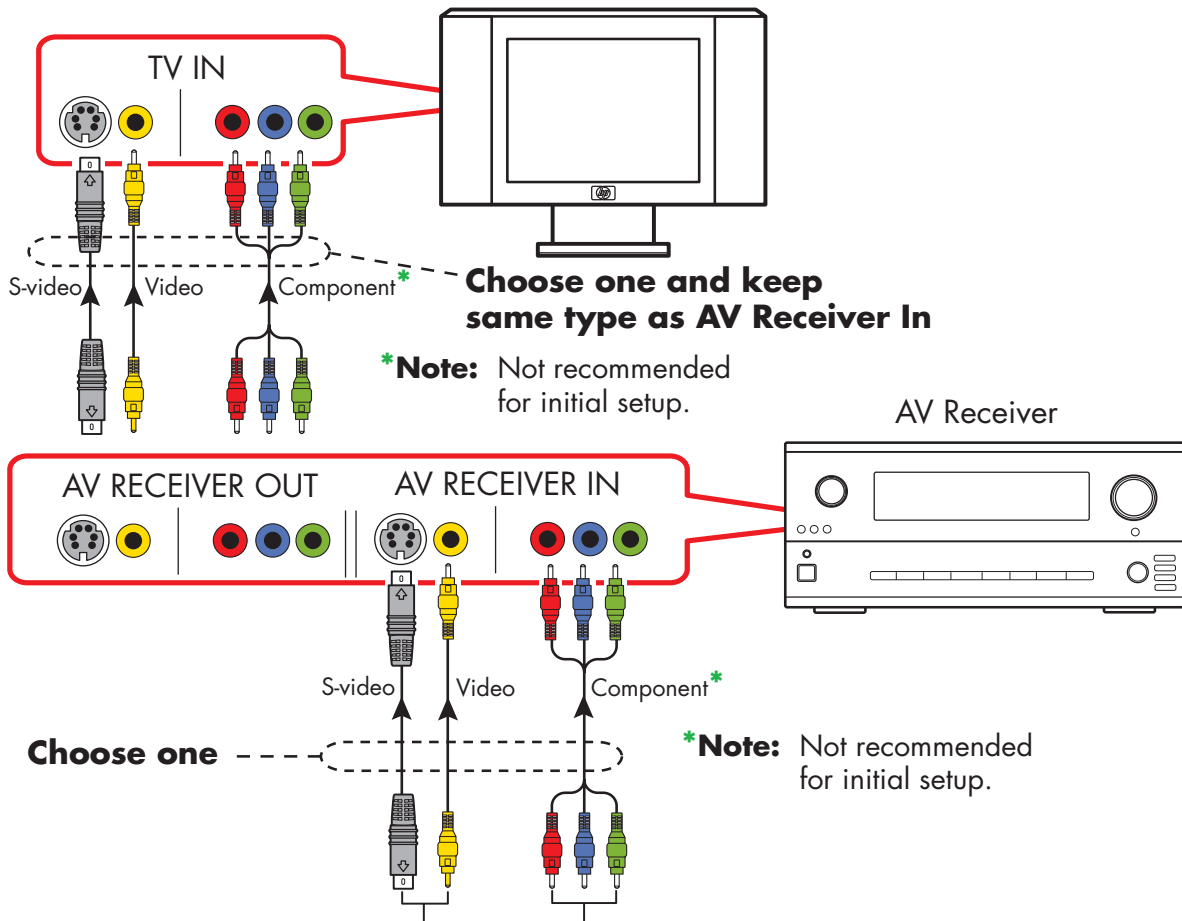

TV Out (through AV receiver)

Video Out to Monitor

Switching: If you have multiple audio/video inputs on your monitor, you can use your monitor as an audio/video switch. You will probably not be able to use a remote control as a switch.

Connectors: For a monitor, choose one of the following Video Out connectors and cables:

- VGA
- DVI



Equipment: The monitor and some cables may not be included with the HP Digital Entertainment Center. See the documentation that came with your monitor.

Configuration: You can adjust the monitor display, after initial power up, using the Media Center software. See "Initial Configuration" on page 121.

Procedure: Connect a monitor video cable from the HP Digital Entertainment Center back panel Video Out directly to the monitor Video In.

If your monitor has multiple input connections, then it has a front panel input switch. You must select the correct input from the monitor front panel or remote control to hear sound and see video.

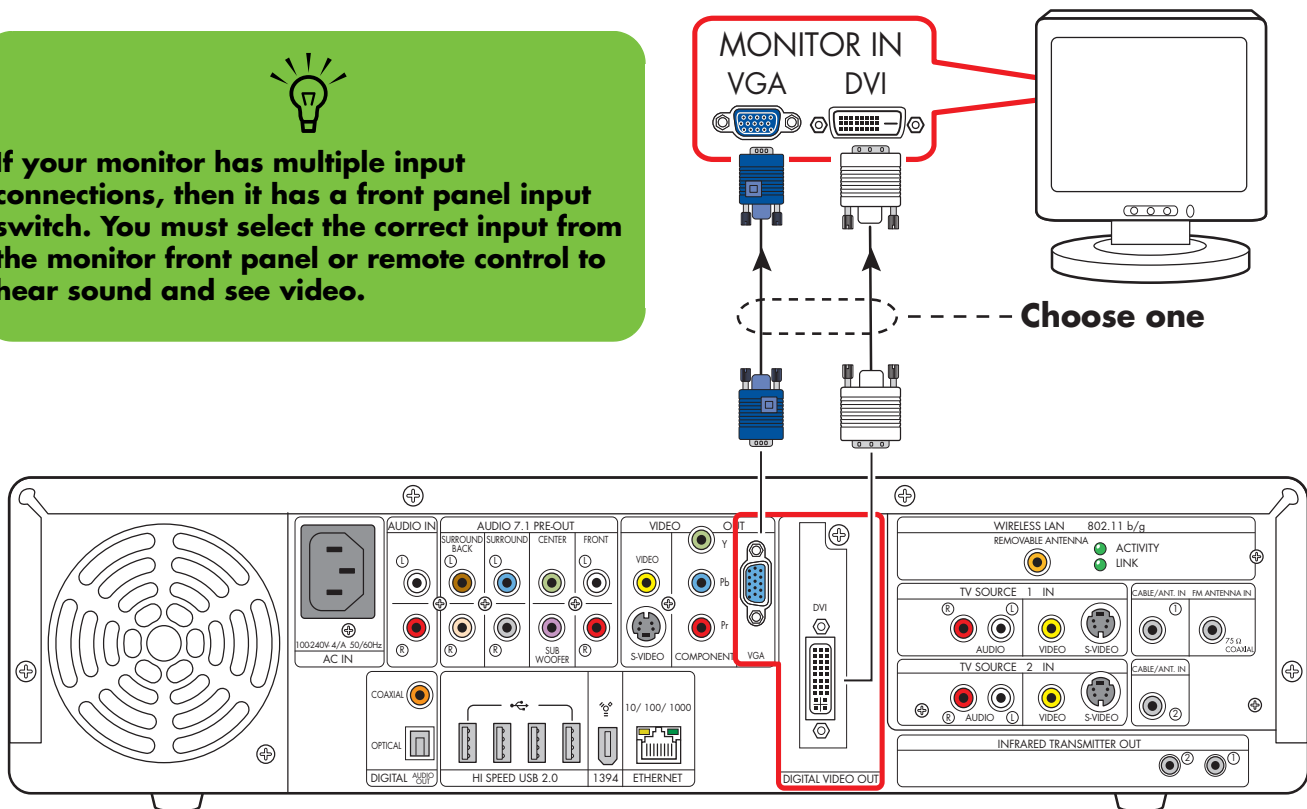

Monitor out

Video Out to TV and Monitor

Switching: If you have multiple audio/video inputs on your TV or monitor, you can use your TV or monitor as an audio/video switch. You can use a TV remote control to switch inputs. If your AV receiver switches video and has the correct connections, you can connect your TV or monitor through your AV receiver.

Connectors: For a television, choose one of the following Video Out connectors and cables:

- Video (composite)
- S-video
- Component (Y, Pb, Pr)



For a monitor, choose one of the following Video Out connectors and cables:

- VGA
- DVI



You can use the following combinations to connect your TV and monitor:

Display	Use with
VGA	Video (composite) S-video Component (Y, Pb, Pr) DVI
DVI	Video (composite) S-video Component (Y, Pb, Pr) VGA

You cannot view any combination of Video (composite), S-video, Component (Y, Pb, Pr) at the same time with dual displays.

Equipment: The TV, monitor, and some cables may not be included with the HP Digital Entertainment Center. See the documentation that came with your TV and monitor.

Configuration: You can adjust the TV and monitor displays, after initial turn on, using the Media Center software. See "Initial Configuration" on page 121.

Procedure:

- 1 Connect a monitor video cable from the HP Digital Entertainment Center back panel Video Out directly to the monitor Video In. Use the VGA or DVI Video Out connectors.
- 2 Connect your TV to the HP Digital Entertainment Center back panel. Use the Video (composite), S-video, or component (Y, Pb, Pr) Video Out connectors.
- 3 After initial turn-on, you will need to activate dual displays. See "Dual screen" on page 134.



If the Video Out S-video and Video (composite) connections are not connected to a TV or video input when the HP Digital Entertainment Center is turned on, the S-video and composite jacks will turn off automatically.

You must restart; press and hold down the power button for four seconds to restart your HP Digital Entertainment Center to ensure Video Out connection to your TV or AV receiver.



Component video output requires specific configurations for certain display types and resolutions. Go to your model number page at <http://www.hp.com/support> for instructions on using component video.



If your TV or monitor has multiple input connections, select the correct input on the TV or monitor.

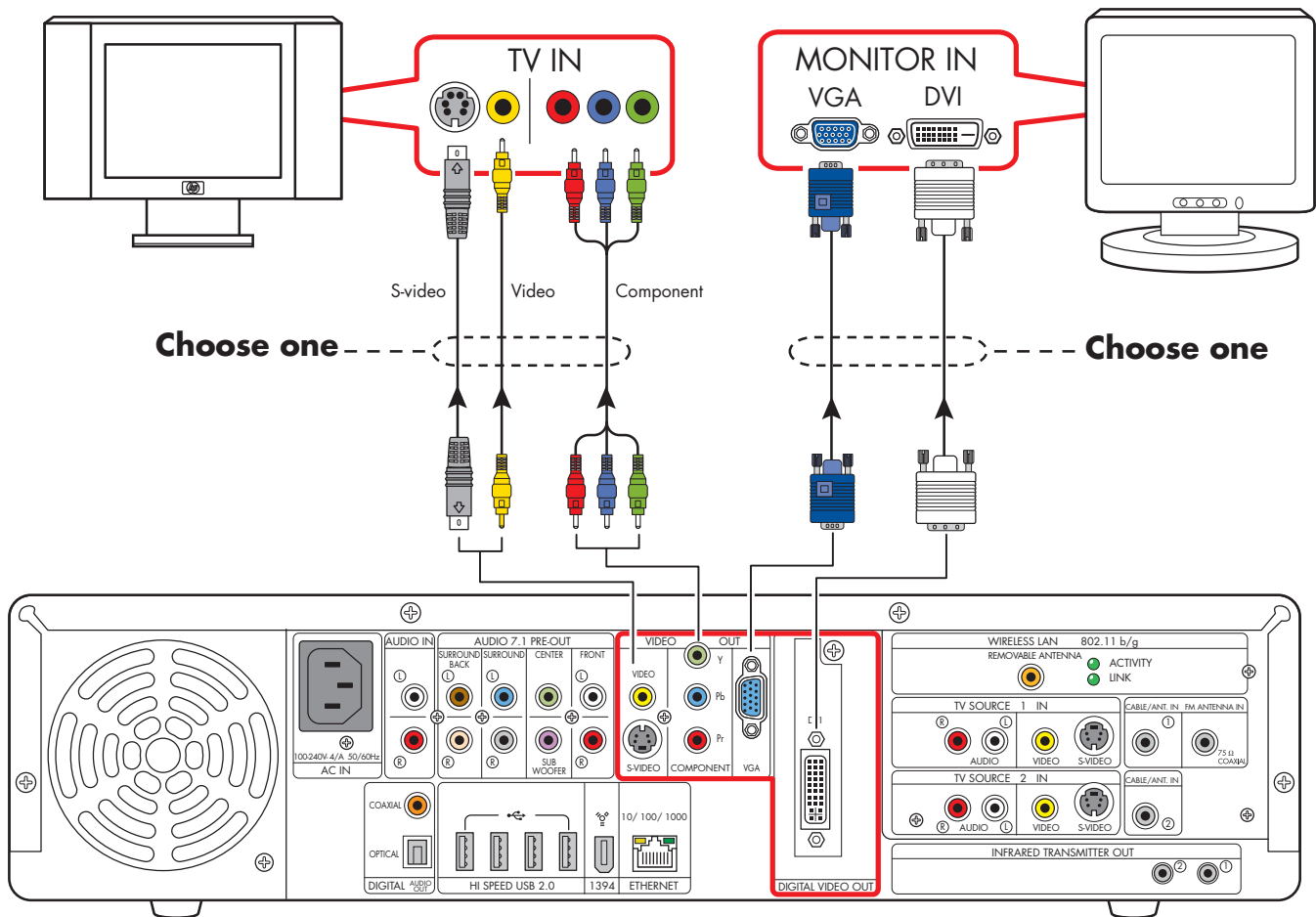

TV and monitor out

Connecting TV Source In

This chapter describes how to connect TV source input from a set-top-box such as a cable box or satellite receiver to the HP Digital Entertainment Center. Infrared Transmitter cable installation is also included.

You connect the HP Digital Entertainment Center to an existing setup for your TV signal source. This chapter includes the most typical, and some advanced, input options.

The HP Digital Entertainment Center supports many different video source input options, connections, and set-top-box configurations, such as a cable box or satellite receiver. Your home system may have different components.

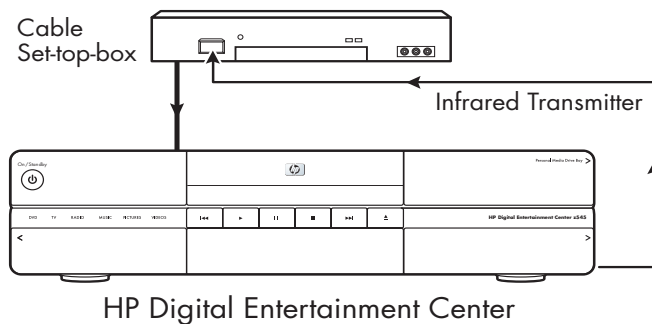

Chapter Contents:

- "TV Source Overview" on page 74
- "Typical TV Source Connections" on page 77
- "Cable Connection" on page 78
- "Satellite Connection" on page 84
- "Infrared Transmitter Connection" on page 88
- "Antenna Connection" on page 92



For additional information on connecting the cable box or satellite receiver, refer to the documentation that came with your equipment and the *Start Here* Booklet included.

TV Source Overview

TV Signal Source Overview

You must have a TV signal into the HP Digital Entertainment Center for proper operation. The back panel connectors are TV Source 1 In and TV Source 2 In:

- For a cable TV box, digital cable box, or satellite receiver: use TV Source 1 In or TV Source 2 In (select models only).
- For an analog cable RF coaxial connector: use cable antenna.

A set-top cable TV box is provided by your cable TV provider to unscramble premium channels.

For Dual Tuner configurations, both TV sources must be of the same type: either cable TV, digital cable TV, satellite TV, or antenna. The TV sources must also have the same, identical channel line-up; for example, if you are using two satellite TV sources they must provide the exact same channels. All TV viewing and scheduling is provided

through the Television Program Guide in Media Center, so both TV sources must have identical Television Program Guides.

The HP Digital Entertainment Center records television and allows you to control the television channels. The HP Digital Entertainment Center has two tuner configurations available:

Single tuner TV Source 1 In	A single tuner allows you to watch or record one program only.
Dual tuner option TV Source 2 In	You can have dual TV inputs, if your HP Digital Entertainment Center includes the two TV tuner option. You can watch a show on one channel while Media Center records another show on a different channel. Or you can record two different programs at the same time, using two tuners.

TV Source Connectors Overview

Your standard television has one or more of the following video input connectors and cables:

- Coaxial (RF)
- Video (composite)
- S-video



The type of video cable you need depends on your TV:

- If your TV has an S-video jack, you need an S-video cable. Use an S-video cable to connect the TV Out on the HP Digital Entertainment Center to your TV. An S-video cable provides separate color and black-and-white image signals, and delivers a sharper image than a composite video cable.
- If your TV has a composite video jack, you need a composite video cable.

You may need other or additional cables, depending on your TV signal source.



Do not switch video types such as connecting a Coaxial In and a Composite Out. Not all set-top-boxes and AV receivers support signal conversion.

TV Source Connectors

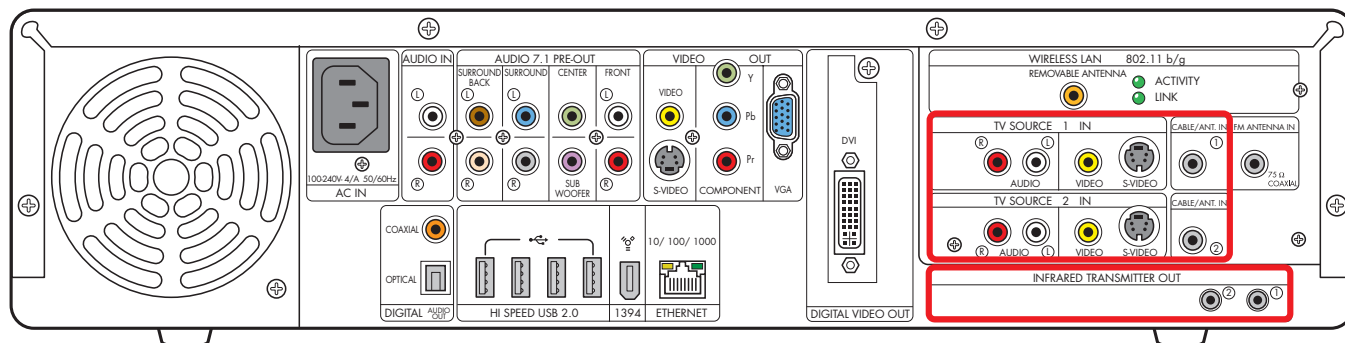
(Location and number of connectors may vary by model.)

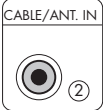

Item	Connector	Type	Color
	Audio TV Source 1 In	RCA jacks	White: left Red: right
	Video (composite) TV Source 1 In	RCA jack	Yellow
	S-video (4-pin) TV Source 1 In	Y/C video Analog 4-pin	Black
	Cable/Antenna In TV Source 1 In	Coaxial	Silver
	Audio TV Source 2 In (Select models only)	RCA jacks	White: left Red: right
	Video (composite) TV Source 2 In (Select models only)	RCA jack	Yellow

Item	Connector	Type	Color
	S-video TV Source 2 In (Select models only)	Y/C video Analog 4-pin	Black
	Cable/Antenna In TV Source 2 In	Coaxial	Silver
	Infrared Transmitter Out	2 ports 1/8-inch (3.5mm) mini-jack	Silver

You may need to purchase additional cables to install the HP Digital Entertainment Center.

Typical TV Source Connections

These are only suggested configurations. Your system may be different.

Select the configuration that most closely matches your home system:

TV source type	Display/video configuration	Connector	See:
Cable	Cable directly from the wall (without a cable TV set-top-box or digital cable receiver)	Cable/Ant	"Cable Only" on page 78
	One cable TV box or digital cable receiver	TV Source 1 In Or Cable/Ant 1	"One Cable TV Box or Digital Cable Receiver" on page 80
	Two cable TV boxes, or digital cable receivers	TV Source 1 In TV Source 2 In Or Cable/Ant 1 Cable/Ant 2	"Two Cable TV Boxes, or Two Digital Cable Receivers" on page 82
Satellite	One satellite receiver	TV Source 1 In Or Cable/Ant 1	"One Satellite Receiver" on page 84
	Two satellite receivers	TV Source 1 In TV Source 2 In Or Cable/Ant 1 Cable/Ant 2	"Two Satellite Receivers" on page 86
Antenna	TV Antenna	Cable/Ant 1 In Cable/Ant 2 In	"Antenna Connection" on page 92

Then see:
"Infrared Transmitter Connection" on page 88 (cable TV box, digital cable receiver, or satellite receiver only)
"Connecting Video Equipment" on page 95

Cable Connection

Cable Only

Location and number of connectors may vary by model.

If you are using a cable without a set-top-box or digital cable receiver, do the following to connect the TV signal source:

- 1 Plug the connector of a coaxial cable from your TV cable (wall) into the Cable/Ant connector on the back of the HP Digital Entertainment Center.



- 2 Turn the connector to tighten it.
- 3 Install a splitter as shown in the following illustration (select models only).

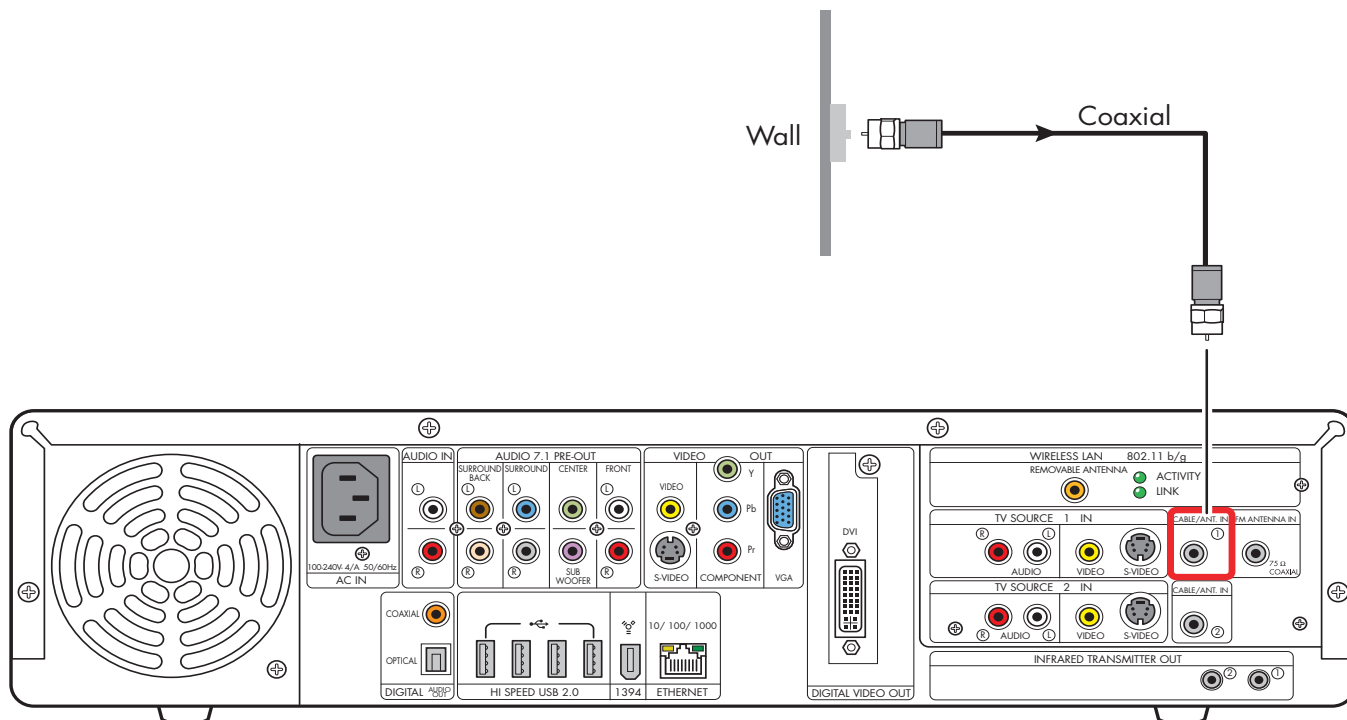

TV signal source (Cable)

Cable Only with Splitter

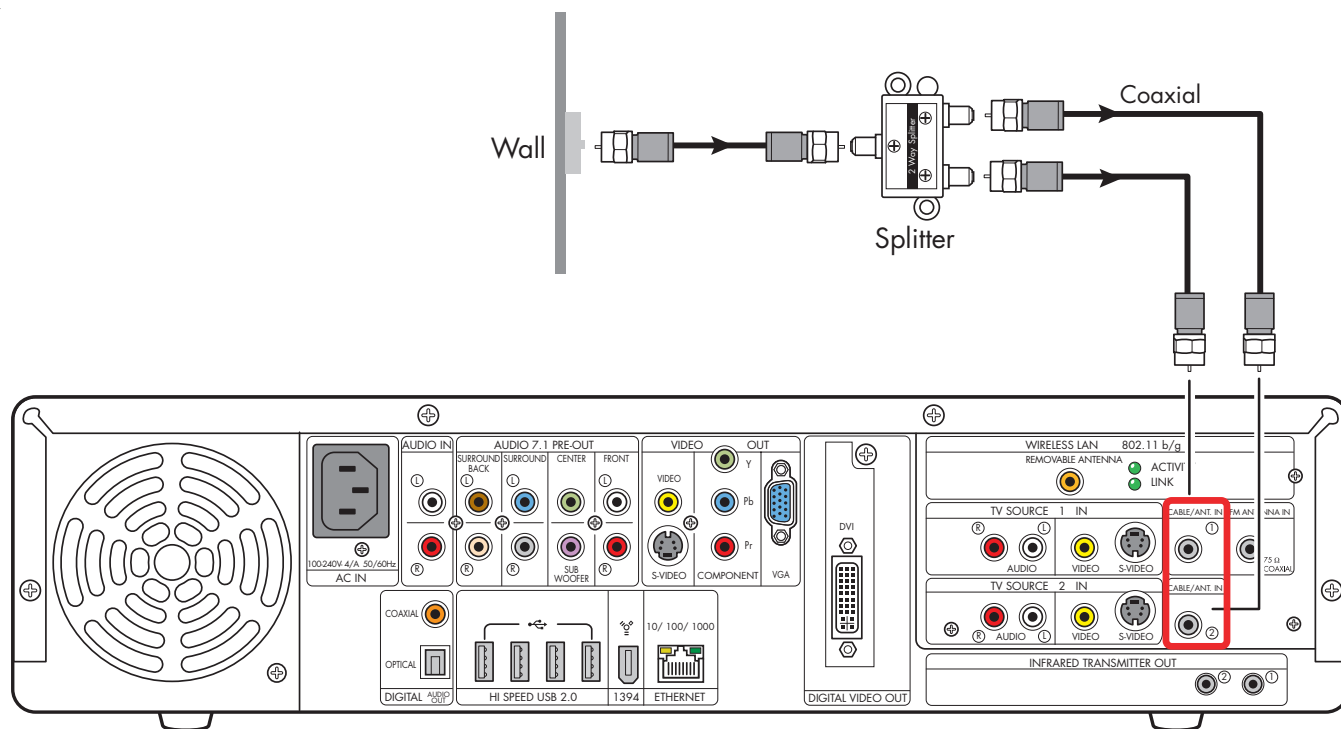

TV signal source – Cable and dual tuners with splitter (select models only)

One Cable TV Box or Digital Cable Receiver

Connect the TV signal source from the Cable TV set-top-box or digital cable receiver (not provided) into the HP Digital Entertainment Center.

If you are using a set-top-box or digital cable receiver with S-video or composite video output, do the following:

1 Make sure that a coaxial cable connector from your cable TV source (wall) is plugged into the set-top-box or digital cable receiver In connector.

2 Connect a video cable:

a Choose a video out connector:

- Coaxial (RF)
- Video (composite)
- S-video



b Connect the video cable from the set-top-box or digital cable receiver back panel Video Output connector.

c Connect the video cable into the HP Digital Entertainment Center back panel TV Source 1 In connector.

3 Connect stereo audio cables (skip this step if using coaxial [RF]):

a From the set-top-box or digital cable receiver back panel Audio Out right (red) and Audio Out left (white) connectors.

b Into the HP Digital Entertainment Center back panel TV Source 1 In Audio right (red) and Audio left (white) connectors.

4 Connect the set-top-box Infrared Transmitter cable (required for signal). See "Infrared Transmitter Connection" on page 88.

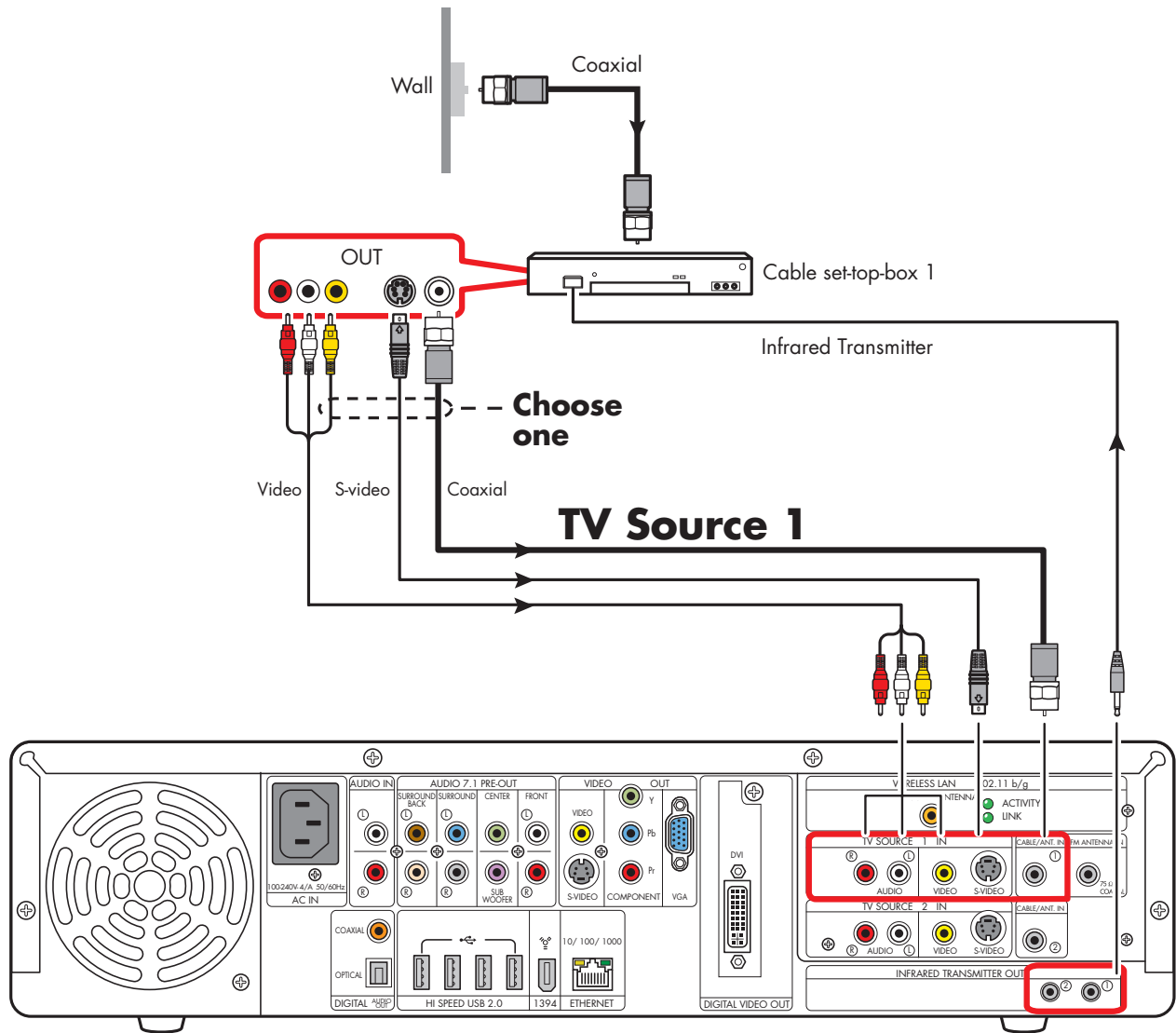

TV signal source – one cable TV or digital cable box

Two Cable TV Boxes, or Two Digital Cable Receivers

You must have two identical set-top-boxes, such as two digital cable receivers or two cable TV boxes (not included), from the same TV source and the HP Digital Entertainment Center dual tuner option (select models only) to set this up. This configuration will allow you to watch live TV on one channel and record another channel at the same time.

Connect the TV signal source from each set-top-box or digital cable receiver into each of the HP Digital Entertainment Center tuners' TV Source 1 and TV Source 2.

If you are using two matching set-top cable boxes or digital cable receivers with S-video or composite video output, do the following:

1 Make sure that:

- **Cable TV box:** A coaxial cable connector from your cable source (wall) is plugged into a cable splitter (provided), then into each cable set-top-box In connector. This setup is similar to the illustration "TV signal source — two digital cable boxes (select models only)" on page 83.
- **Digital cable receiver:** A coaxial cable connector from two cable sources (wall) is plugged into each digital cable receiver IN connector. See "TV signal source — two digital cable boxes (select models only)" on page 83.

2 Connect a video cable for set-top-box 1.

a Choose a Video Out connector:

- Coaxial (RF)
- Video (composite)
- S-video



- ### b Connect the video cable from the set-top-box or digital cable receiver back panel video output connector.

- ### c Connect the video cable into the HP Digital Entertainment Center back panel TV Source 1 In connector.

3 Connect stereo audio cables for set-top-box 1 (skip this step if using coaxial [RF]):

- a From the set-top-box or digital cable receiver back Audio Out right (red) and Audio Out left (white) connectors.
- b Into the HP Digital Entertainment Center back panel TV Source 1 In Audio right (red) and Audio left (white) connectors.

4 Connect a video cable for set-top-box 2:

- ### a Choose a video out connector, use the same type as set-top-box 1:

- Coaxial (RF)
- Video (composite)
- S-video



- ### b Connect the video cable from the set-top-box or digital cable receiver back panel video output connector.

- ### c Connect the video cable into the HP Digital Entertainment Center back panel TV Source 2 In connector.

5 Connect stereo audio cables for set-top-box 2 (skip this step if using coaxial [RF]):

- a From the set-top-box or digital cable receiver back Audio Out right (red) and Audio Out left (white) connectors.
- b Into the HP Digital Entertainment Center back panel TV Source 2 In Audio right (red) and Audio left (white) connectors.

6 Connect the set-top-box 1 Infrared Transmitter cable (required for signal). See "Infrared Transmitter Connection" on page 88.

7 Connect the set-top-box 2 Infrared Transmitter cable (required for signal). See "Infrared Transmitter Connection" on page 88.

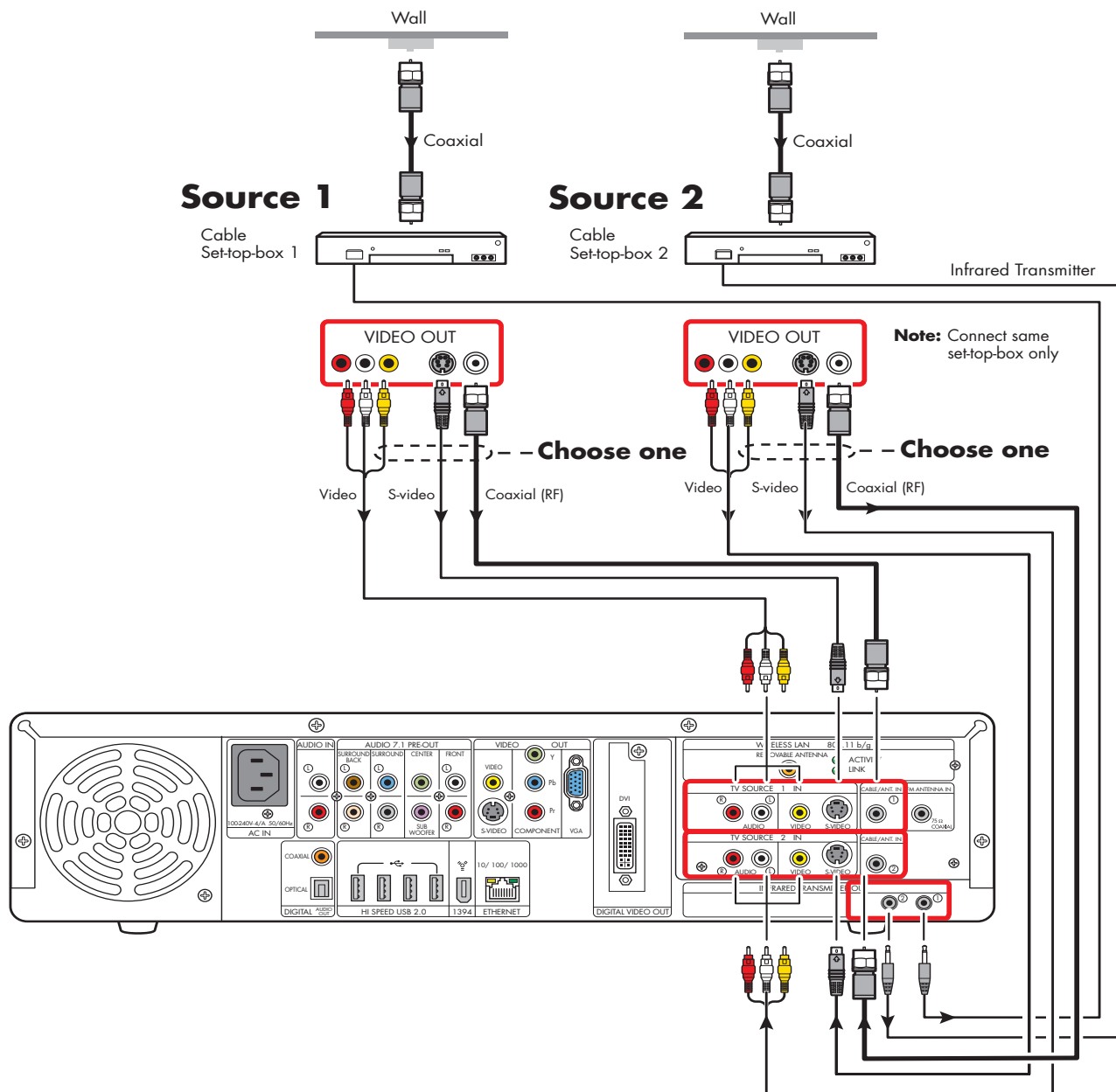



TV signal source – two digital cable boxes (select models only)

Satellite Connection

One Satellite Receiver

Connect the TV signal source from the satellite receiver into the HP Digital Entertainment Center.

If you are using a satellite receiver (not provided) with S-video or composite video output, do the following:

- 1** Make sure that a coaxial cable connector from your dish source is plugged into the satellite receiver In connector.
- 2** Connect a video cable.
 - a** Choose a Video Out connector:
 - Coaxial (RF) 
 - Video (composite) 
 - S-video 
 - b** Connect the video cable from the satellite receiver back panel video output connector.
 - c** Connect the video cable into the HP Digital Entertainment Center back panel TV Source 1 In connector.
- 3** Connect stereo audio cables (skip this step if using coaxial [RF]):
 - a** From the satellite receiver back panel Audio Out right (red) connector and Audio Out left (white) connectors.
 - b** Into the HP Digital Entertainment Center back panel TV Source 1 In Audio right (red) and Audio left (white) connectors.
- 4** Connect the satellite receiver Infrared Transmitter cable (required for signal). See "Infrared Transmitter Connection" on page 88.

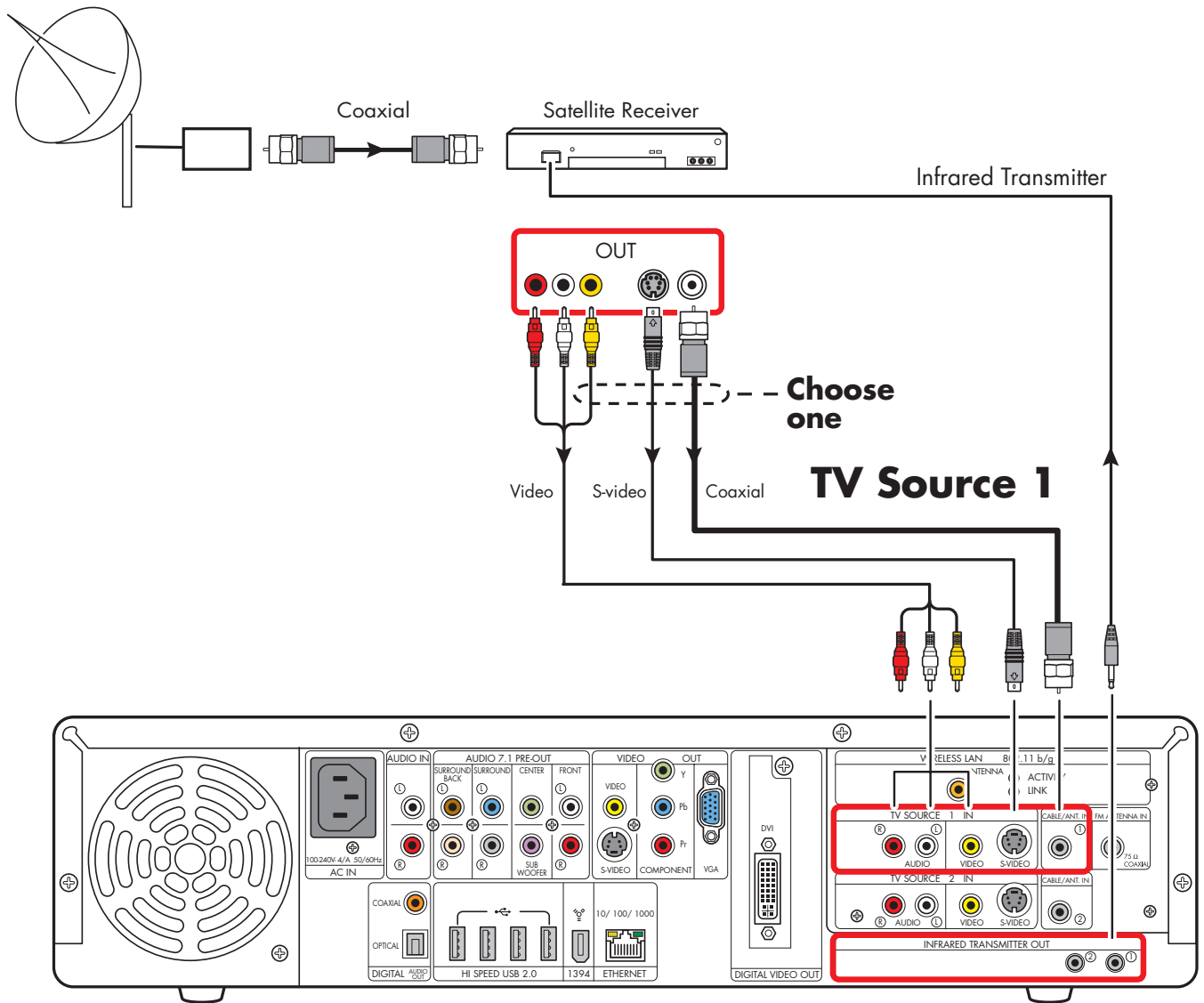



TV signal source – one satellite receiver



Two Satellite Receivers

You must have two identical satellite receivers from the same source and the HP Digital Entertainment Center dual tuner option (select models only) to set this up. This configuration will allow you to watch live TV on one channel and record another channel at the same time.

Connect the TV signal source from each satellite receiver into each HP Digital Entertainment Center tuner.

If you are using two matching satellite receivers with S-video or composite video output, do the following:

- 1** Make sure that a coaxial cable connector from your dish source is plugged into two cable outputs, and each satellite receiver In connector.
- 2** Connect a video cable for satellite receiver 1:
 - a** Choose a Video Out connector:
 - Coaxial (RF) 
 - Video (composite) 
 - S-video 
 - b** Connect the video cable from the satellite receiver back panel video output connector.
 - c** Connect the video cable into the HP Digital Entertainment Center back panel TV Source 1 In connector.

- 3** Connect stereo audio cables for satellite receiver 1 (skip this step if using coaxial [RF]):
 - a** From the satellite receiver back panel Audio Out right (red) connector and the Audio Out left (white) connectors.
 - b** Into the HP Digital Entertainment Center back panel TV Source 1 In Audio right (red) and Audio left (white) connectors.
- 4** Connect a video cable for satellite receiver 2:
 - a** Choose a video out connector, use the same type as satellite receiver 1:
 - Coaxial (RF) 
 - Video (composite) 
 - S-video 
 - b** Connect the video cable from the satellite receiver back panel video output connector.
 - c** Connect the video cable into the HP Digital Entertainment Center back panel TV Source 2 In connector.
- 5** Connect stereo audio cables for satellite receiver 2 (skip this step if using coaxial [RF]):
 - a** From the satellite receiver back panel Audio Out right (red) connector and Audio Out left (white) connectors.
 - b** Into the HP Digital Entertainment Center back panel TV Source 2 In Audio right (red) and Audio left (white) connectors.

6 Connect the satellite receiver 1 Infrared Transmitter cable (required for signal). See "Infrared Transmitter Connection" on page 88.

7 Connect the satellite receiver 2 Infrared Transmitter cable (required for signal). See "Infrared Transmitter Connection" on page 88.

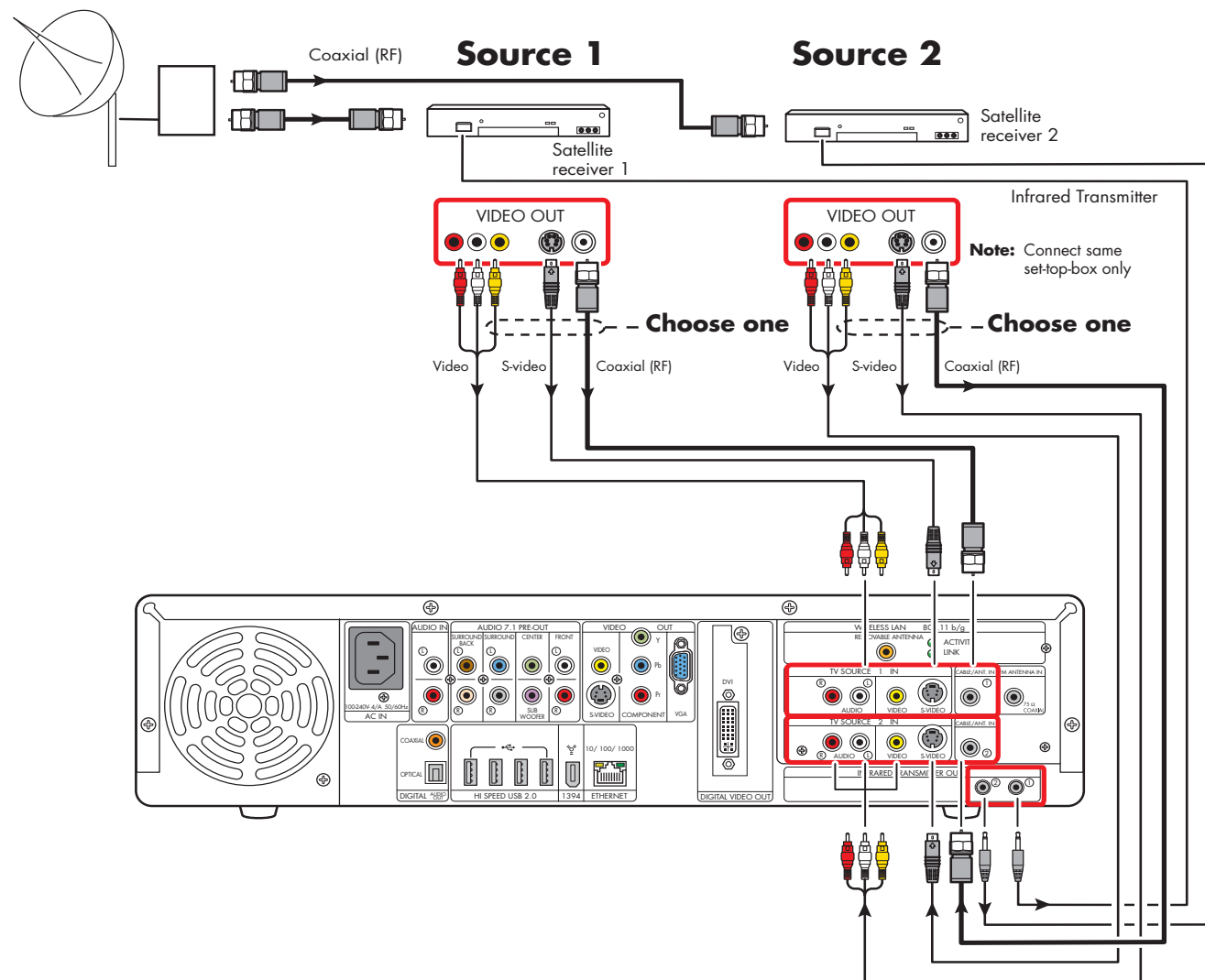

TV signal source – two satellite receivers (select models only)

Infrared Transmitter Connection

Infrared Transmitter Overview

The HP Digital Entertainment Center includes infrared transmitters that make it easy to control one or two set-top-boxes. If you connect a set-top-box such as a digital cable box or a satellite receiver to the HP Digital Entertainment Center, then you must also use the Infrared (IR) Transmitter control cable.

The **remote control** sends commands to the HP Digital Entertainment Center which relays these commands via the IR transmitter control cables to the cable box or satellite receiver.

The **Infrared Transmitter** control cable has a sender tip (IR Blaster) that attaches to the front of the cable box (or other set-top-box) and plugs into the back of the HP Digital Entertainment Center.

You must carefully position the Infrared Transmitter control cable sender tip on to the set-top-box front panel to ensure the set-top-box receives the signal.

The **remote receiver** is on the front of the cable box, digital cable box, or satellite receiver. It receives Infrared commands from your cable box remote control or from the IR transmitter cable. The remote receiver is sometimes hidden behind a panel of dark, transparent plastic. You can use a flashlight to locate it. For more information about the remote receiver, refer to the documentation for your cable box, digital cable box, or satellite receiver.



The Infrared Transmitter connection is required for a signal with a set-top-box.

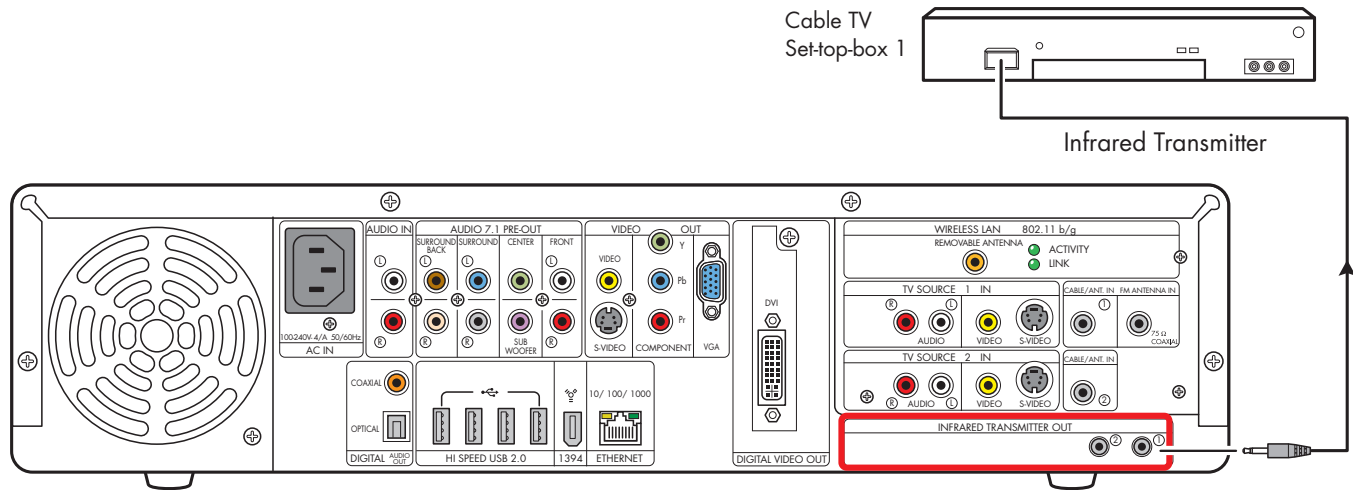

Infrared Transmitter connection (one set-top-box)

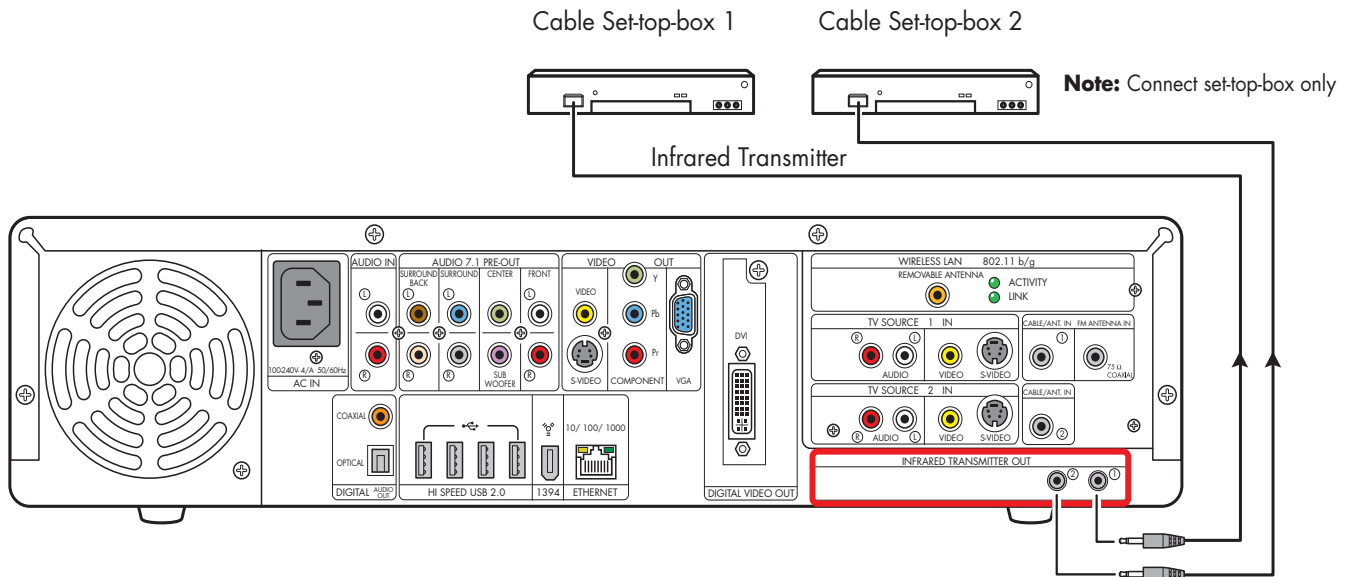

Infrared Transmitter connection (two set-top-boxes; select models only)

Infrared Transmitter Installation

If you have a cable TV receiver, satellite receiver, or other set-top-box that controls your TV signal, connect the Infrared Transmitter Sensor:

- 1** Route the IR transmitter cable from the back of the HP Digital Entertainment Center to the cable TV, digital cable, or satellite receiver set-top-box.
- 2** Locate the IR remote receiver area on the front of the set-top-box. This is where you aim the set-top-box remote control to change channels, change the sound level, and so on.
 - The IR remote receiver area may be behind an obvious window on the set-top-box.
 - Use the set-top-box remote control to locate its IR remote receiver area: Hold the remote control very close (within 1-inch / 2.54-centimeters) and press a remote button to change the channel or power off the box. As you push a button, gradually move the remote control across the front of the box until the box responds.
 - Hold a flashlight close to the front of the set-top-box and look for a transparent window with a small box inside. Test the area by holding the box remote close to the window and pushing a button until the box responds.
- 3** Use a piece of tape to temporarily hold the IR transmitter cable tip over the set-top-box IR remote receiver area while you test the function.
- 4** Plug the IR transmitter cable into the Infrared Transmitter connector on the back of the HP Digital Entertainment Center.
- 5** Test the operation by pointing the HP Digital Entertainment Center remote control at the HP Digital Entertainment Center IR receiver and pressing a channel button. (Be sure you use the HP Digital Entertainment Center remote and point it at the HP Digital Entertainment Center.)
- 6** For permanent attachment, remove the paper from the IR transmitter cable tip and press the tip onto the IR remote receiver area on the set-top-box.
- 7** Repeat these steps for the second set-top-box.

The following illustration shows the Infrared Transmitter installation.

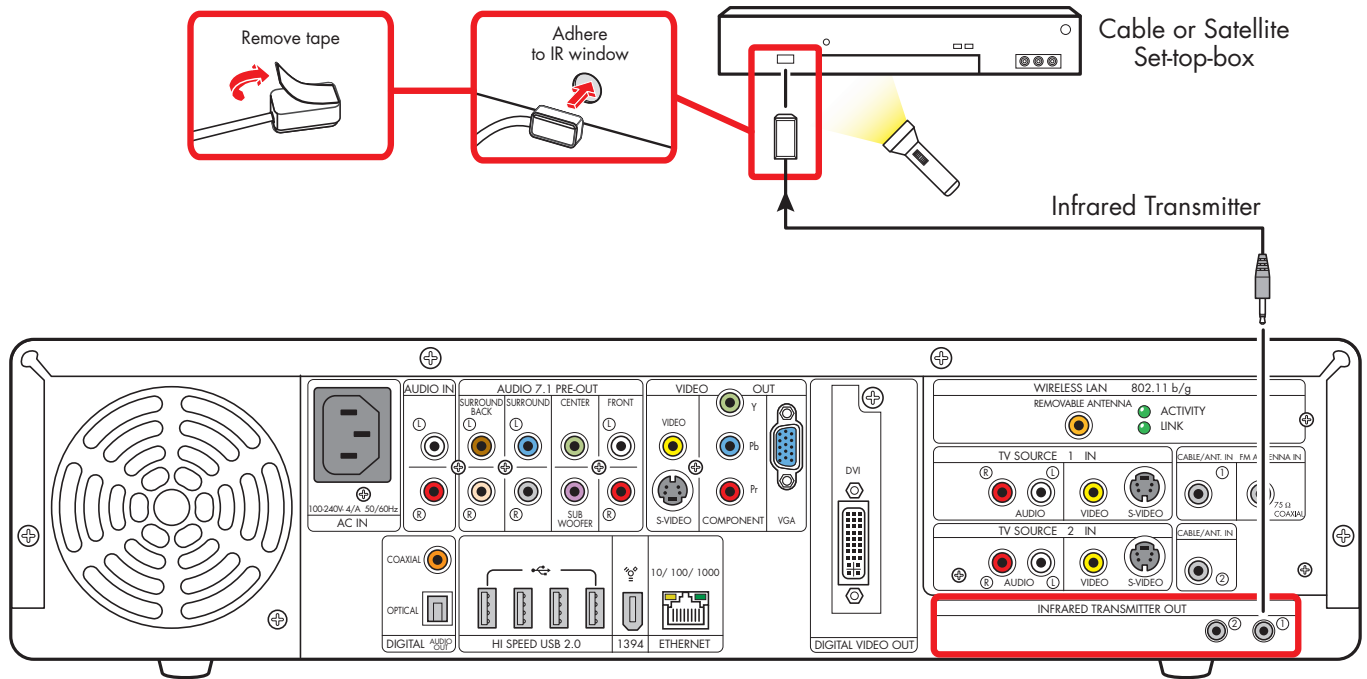

Infrared Transmitter to cable, digital cable receiver, or satellite receiver set-top-box

Antenna Connection

If you are using a broadcast television antenna (not provided) with no cable TV box, digital cable box, or satellite receiver, do the following to connect the TV signal source:

- 1 Plug the connector of a coaxial cable from your external or internal TV antenna into the Cable/Ant connector on the back of the HP Digital Entertainment Center.
- 2 Turn the connector to tighten it.

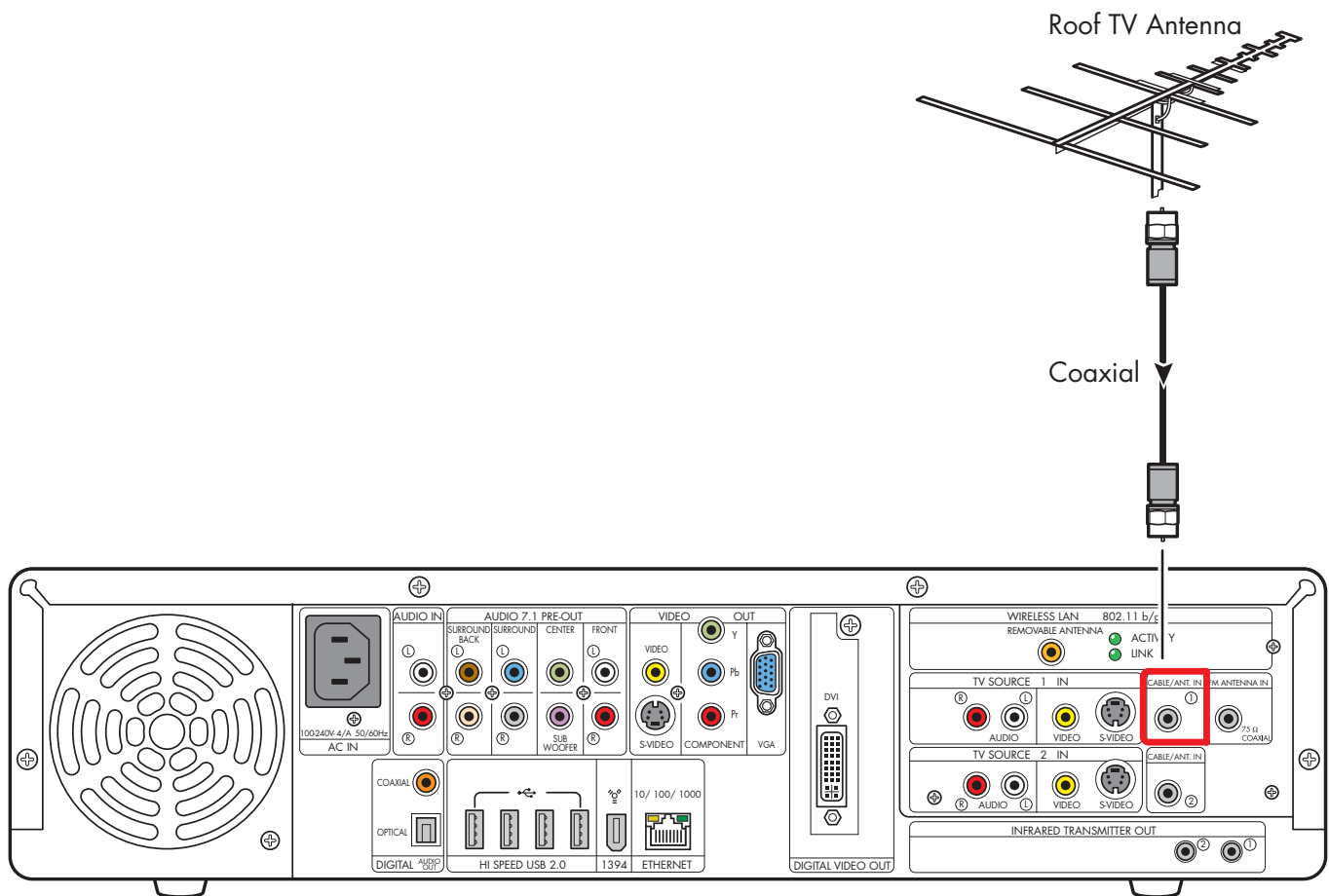

TV signal source – TV antenna

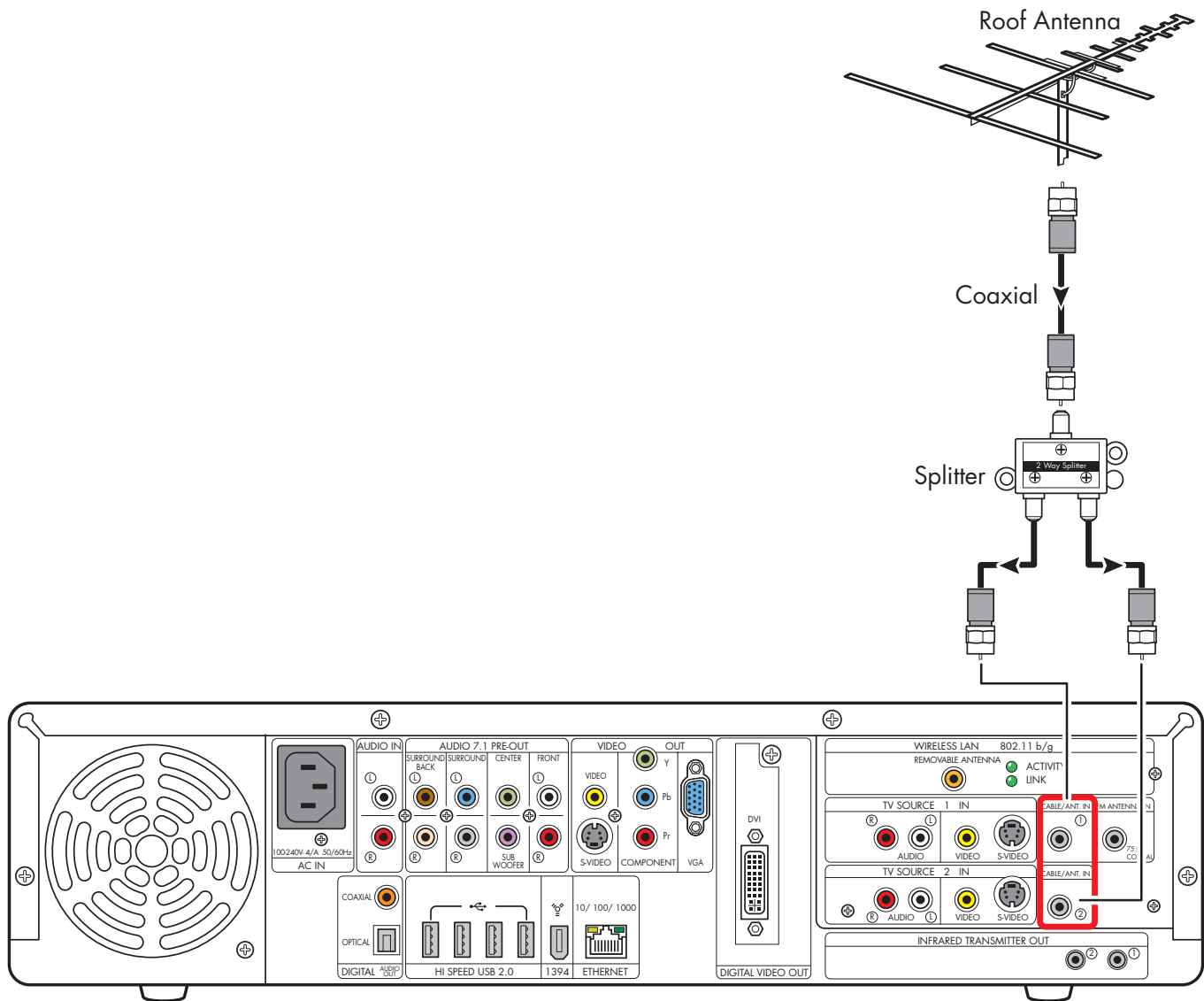

TV signal source – TV antenna and dual tuners with splitter

Connecting Video Equipment

This chapter describes how to connect video playback and recording equipment to the HP Digital Entertainment Center. Equipment includes VCRs and camcorders. This chapter also includes the most typical, and some advanced, options.

The HP Digital Entertainment Center supports many different video input and audio/video output options and connections. Your system may have different components.

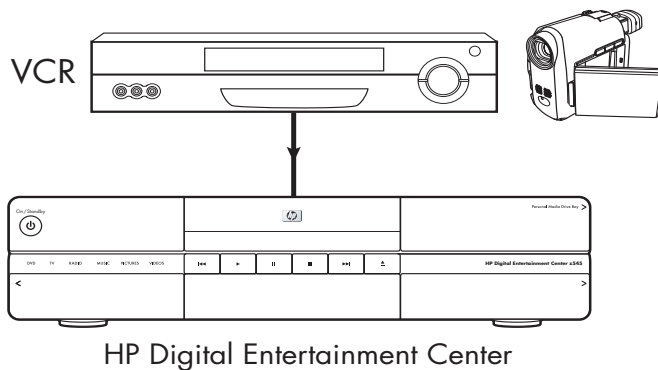

Chapter Contents:

"Video Equipment Overview" on page 96

"Typical Video Equipment Connections" on page 98

"VCR Connection" on page 99







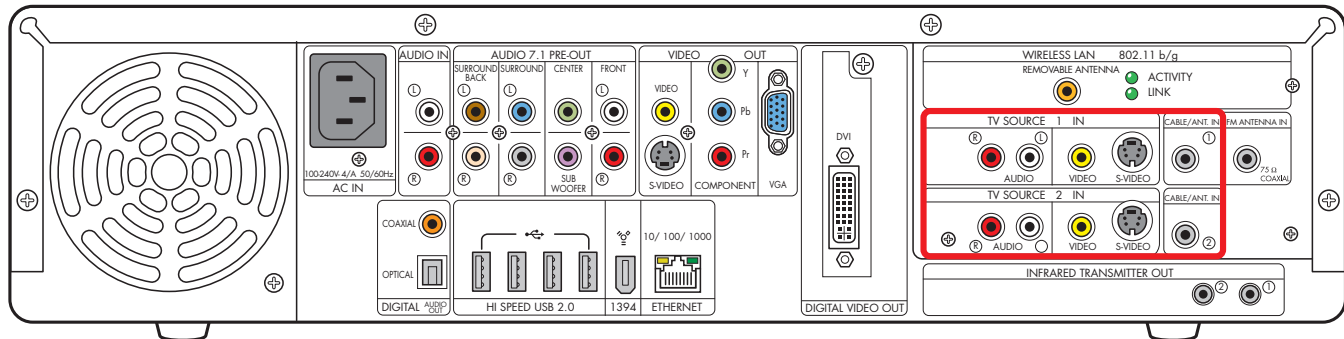

"Video Camera Connection" on page 103

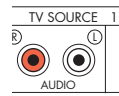
Video Equipment Overview

Connectors

(Location and number of connectors may vary by model.)



Item	Connector	Type	Color
	Audio: TV Source 1 In	RCA jacks	White: left Red: right
	Video: TV Source 1 In	RCA jack	Yellow
	S-video TV: Source 1 In	Analog: Y/C video 4-pin	Black
	Cable/Antenna In: TV Source 1	Coaxial	Silver
	Audio: TV Source 2 In	RCA jacks	White: left Red: right
	Video: TV Source 2 In	RCA jack (optional)	Yellow
	S-video TV: Source 2 In	Analog: Y/C video 4-pin (optional)	Black
	Cable/Antenna In: TV Source 2	Coaxial	Silver

You may need to purchase additional cables to install the HP Digital Entertainment Center.

Video Equipment Connection Overview

Standard video equipment has one or more of the following video out connectors and cables:

- Coaxial (RF)
- Composite
- S-video



The type of video cable you need depends on your video equipment:

- If your video equipment has an S-video jack, you need an S-video cable. An S-video cable provides separate color and black-and-white image signals, and delivers a sharper image than a composite video cable does.
- If your video equipment has a composite video jack, you need a composite video cable.

You may need other or additional cables, depending on your video equipment.



If your video equipment has multiple input and output connections, then it has front panel input and output switches.

You must select the correct input and output from the video equipment front panel or remote control to hear sound and see video.

You can also connect your digital video camera to work with the HP Digital Entertainment Center through FireWire (IEEE 1394) connectors.

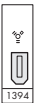

DVD Player

The HP Digital Entertainment Center has a built-in DVD player/recorder.



The HP Digital Entertainment Center is not designed to record retail movie title DVDs.



Connect video game boxes directly to your TV.

Typical Video Equipment Connections

This section describes how to connect the HP Digital Entertainment Center to an existing setup of your video equipment.

These are only suggested configurations. Your system may be different.

Select the configuration that most closely matches your home system:

TV source type	Display/video configuration	See:
VCR	VCR direct to HP Digital Entertainment Center	"VCR Direct in Connection" on page 99
	From HP Digital Entertainment Center to VCR to TV	"Wall to VCR to TV Using Coaxial Cable" on page 100
Camcorder	Digital	"Connecting a Digital Video Camera" on page 103
	Analog	"Connecting an Analog Camcorder" on page 106

Then see:

"Connecting the Network" on page 107

"Initial Configuration" on page 121

VCR Connection

VCR Direct in Connection

You can connect a VCR to record your tapes to the HP Digital Entertainment Center hard disk drive.



Some retail VHS tapes have content protection measures that corrupt recorded images or do not allow recording.

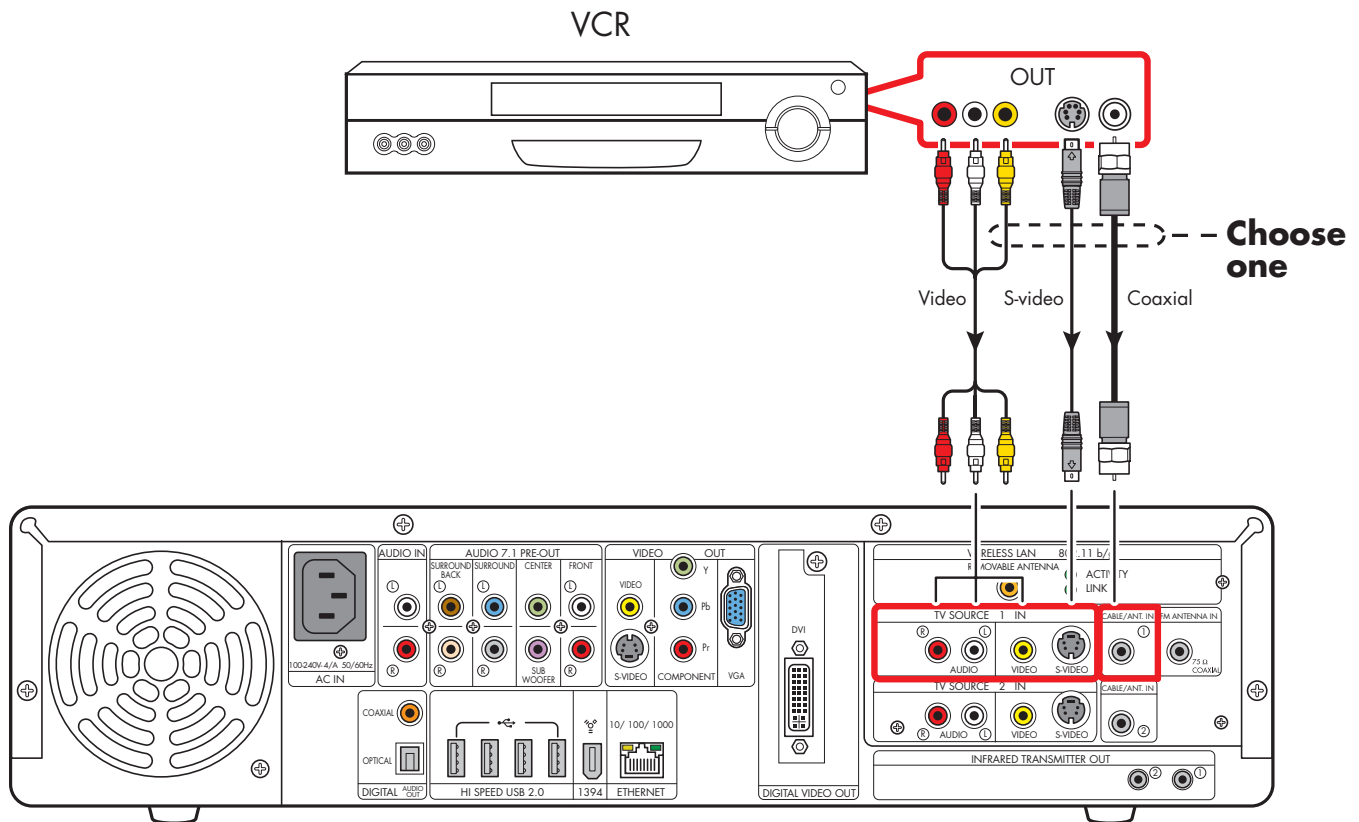

VCR connection

Wall to VCR to TV Using Coaxial Cable

- 1 Remove the coaxial cable at the input to the VCR.
- 2 Connect the coaxial cable to the input of a signal splitter (available at electronics stores).
- 3 Connect two coaxial cables to the splitter outputs.
- 4 Connect one coaxial cable to the input of the VCR.
- 5 Connect one coaxial cable to the TV Source 1 in back of the HP Digital Entertainment Center.
- 6 Connect a coaxial cable from the VCR out to one of the TV inputs. Reserve an input connection on the TV for the HP Digital Entertainment Center.

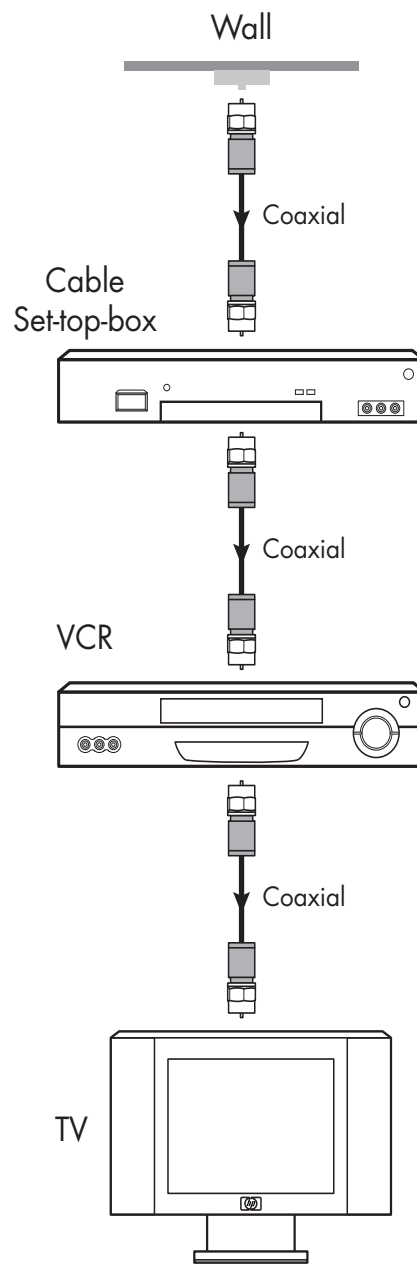
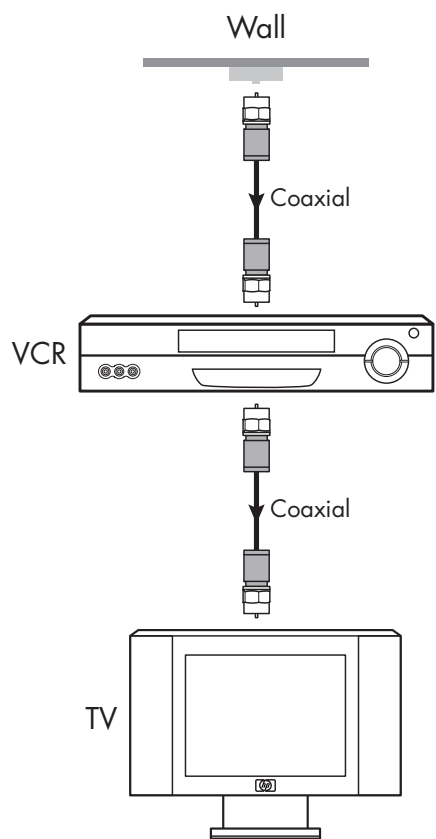

Existing setups with and without set-top-box

100 HP Digital Entertainment Center

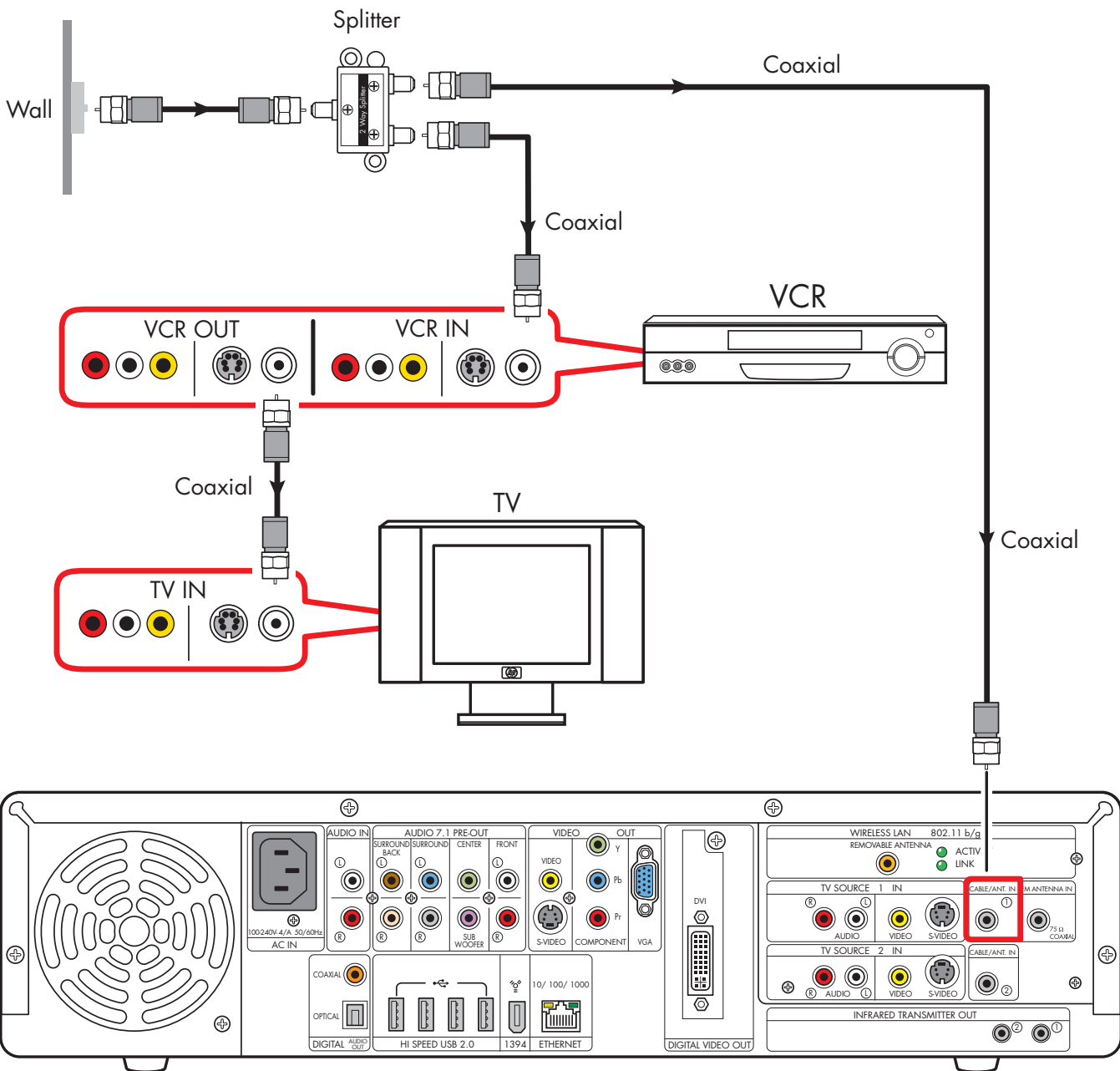

Connecting Video Equipment

Wall to VCR to TV using coaxial cable (Add the HP Digital Entertainment Center with a splitter)

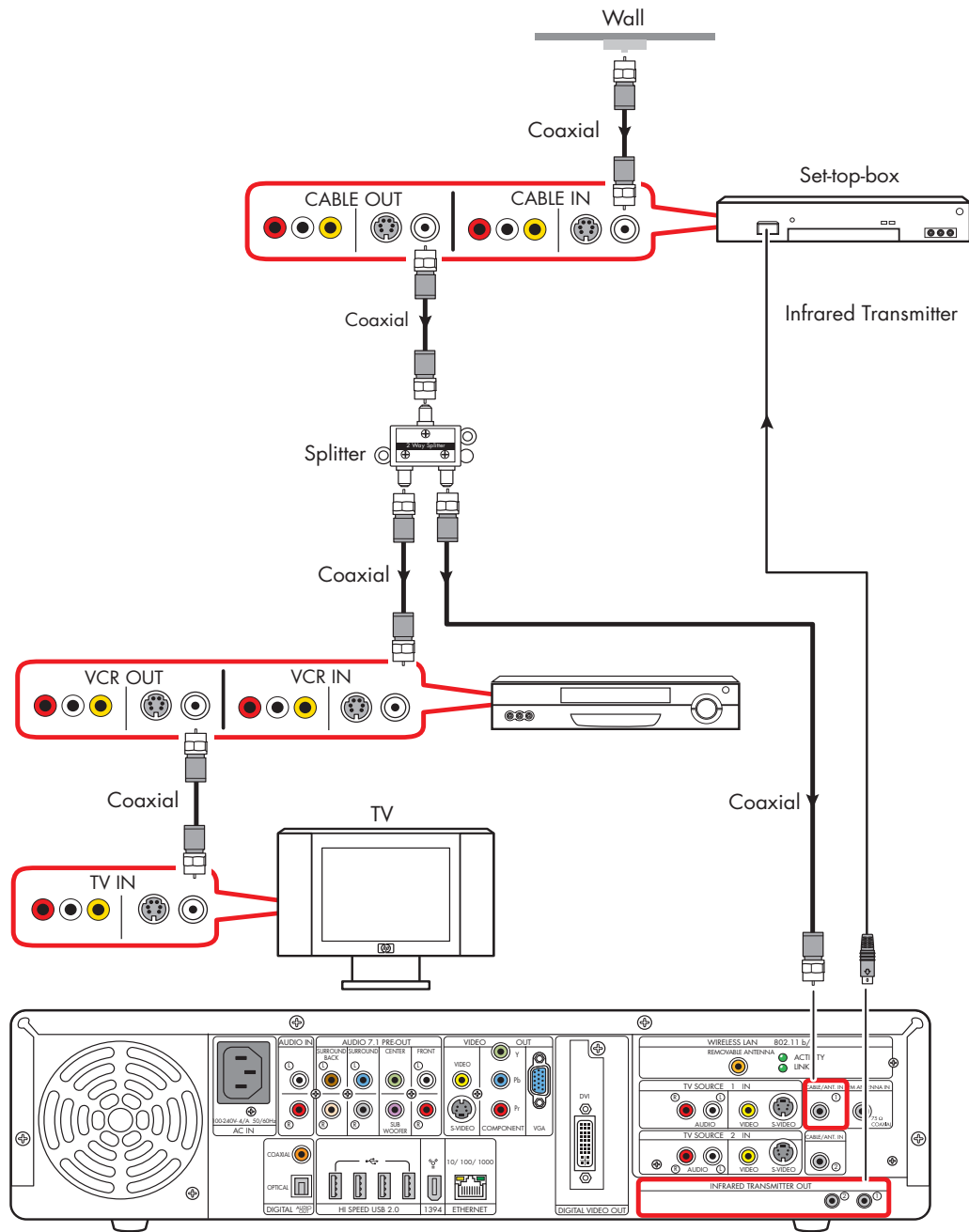

Wall to set-top-box VCR to TV using coaxial cable (add with a splitter)

Video Camera Connection

Refer to the HP support Web site for detailed information on advanced video setup. See "HP Web Site Support" on page 152.

Connecting a Digital Video Camera

Connectors:

Use the 4-pin FireWire (IEEE 1394) connector on the front or 6-pin FireWire (IEEE 1394) connector on the back panel of the HP Digital Entertainment Center to connect a digital video camera. This connector is bi-directional.

Some cameras use a USB connector. See the documentation that came with your digital video camera. See "USB Device Connection" on page 115.

Equipment:

Most digital video cameras use either a 4-pin to 4-pin or a 4-pin to 6-pin FireWire (IEEE 1394) video camera transfer cable. You may have to purchase a 4-pin to 4-pin FireWire (IEEE 1394) cable to use the 4-pin FireWire (IEEE 1394) connector on the HP Digital Entertainment Center front panel.

Procedure:

The following instructions apply only to digital video cameras. See "Connecting an Analog Camcorder" on page 106 for analog video cameras.

If a Digital Video Device Auto Play window appears when you connect your camera, click Cancel.

To connect a digital video camera:

- 1 Turn on the HP Digital Entertainment Center, and wait for the desktop to appear. See "Initial Configuration" on page 121.
- 2 Turn on the digital video camera.
- 3 Connect the video camera transfer cable from the camera to a FireWire (IEEE 1394) connector on the front (4-pin) or back (6-pin) of the HP Digital Entertainment Center.
- 4 A *Found New Hardware* message appears. Wait two or three minutes for the system to make the necessary settings for the new device. When installation is complete, a message appears telling you the camera is ready to use.

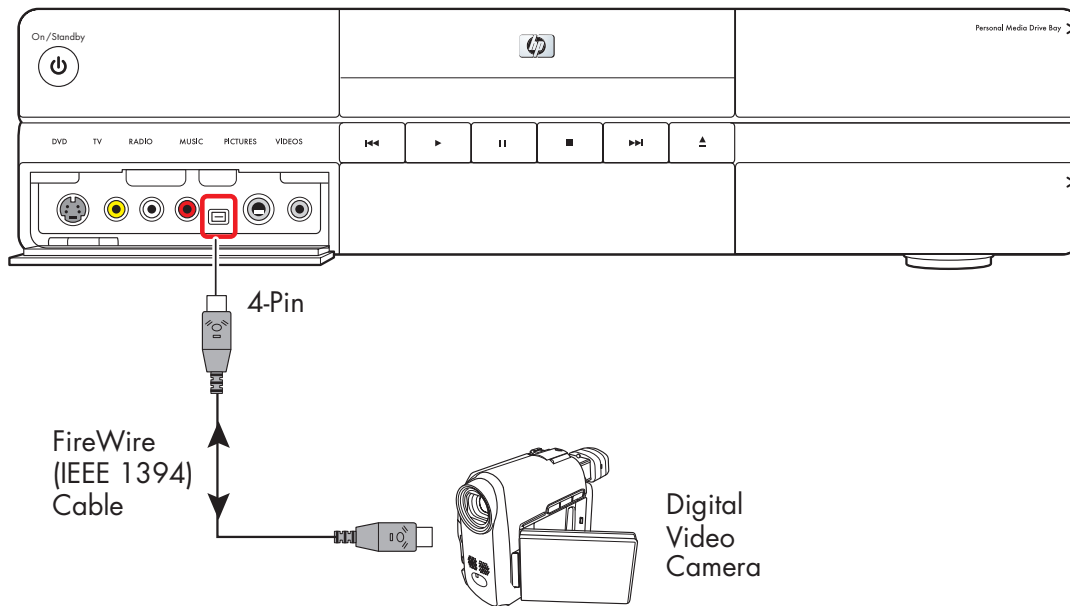

Connect a digital video camera (front panel)

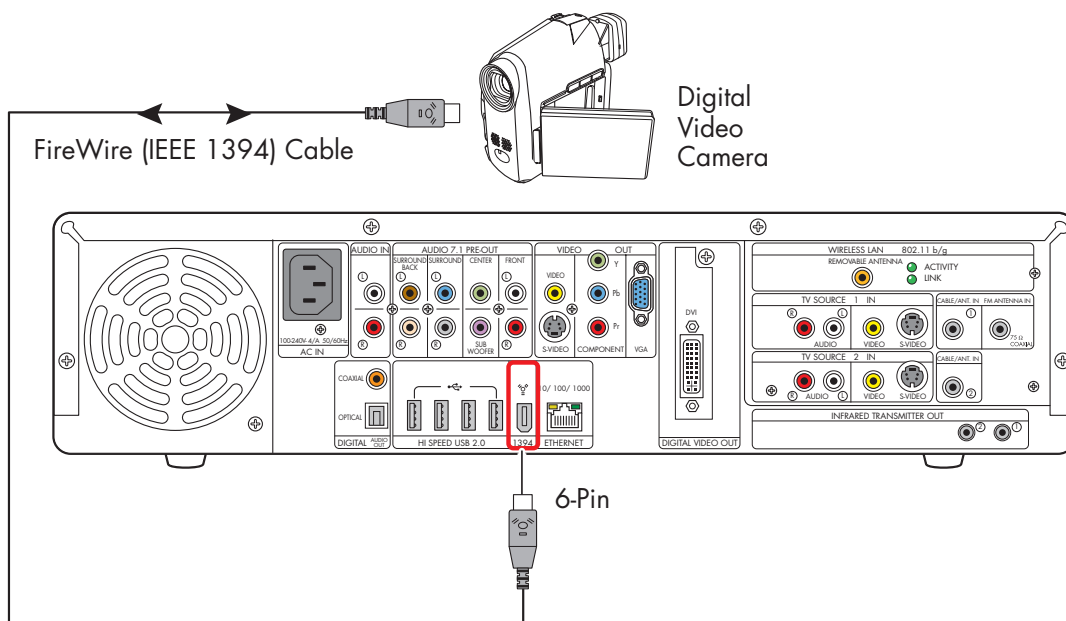

Connect a digital video camera (back panel)

Recognizing the camera

If the HP Digital Entertainment Center does not recognize your digital video camera:

- 1 Start up the HP Digital Entertainment Center. See "Initial Configuration" on page 121.
 - 2 Click **Start**, and then click **Control Panel**.
 - 3 Click **Performance and Maintenance**, if available, and then double-click the **System** icon.
 - 4 Click the **Hardware** tab, and then click the **Device Manager** button.
- 5 Click the plus sign (+) next to imaging devices. If the name of the camera appears under imaging devices the device is ready. If the name is not there, try the following:
 - Click **Action**, and then **Scan for hardware changes**. Look in Device Manager for a new addition under imaging devices.
 - Unplug the video camera's transfer cable from the HP Digital Entertainment Center. Power cycle the camera and plug it back in. Look in Device Manager for a new addition under imaging devices.

For more information about viewing your pictures or digital video files in Media Center or copying your pictures to CD, see the *Media Center Edition 2005 Software Guide*.

Connecting an Analog Camcorder

Connecting an analog camera for video input (capture)

Connectors:

When connecting an analog video camera for input to the HP Digital Entertainment Center, use the Video and Audio In connectors on the front of the HP Digital Entertainment Center.

Procedure:

The following instructions can also be used to connect digital cameras with analog outputs.

See the documentation that came with your video camera.

To connect an analog video camera:

- 1 Turn on the HP Digital Entertainment Center, and wait for the desktop to appear. See "Initial Configuration" on page 121.
- 2 Connect the video camera transfer cable from the camera to the S-video connector or to the composite and audio connectors on the front of the HP Digital Entertainment Center.
- 3 Turn on the camera and use InterVideo WinDVD Creator to capture your video recording.

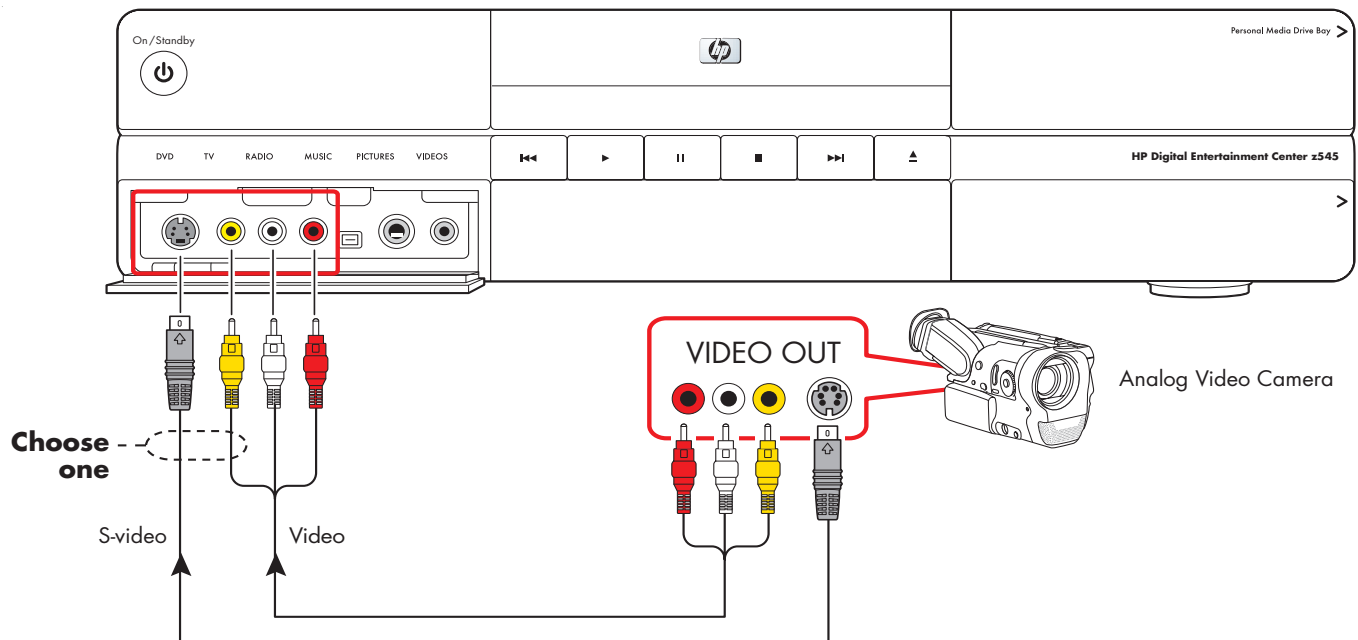

Connect an analog video camera for source input

Connecting the Network

Your system must have working broadband Internet to operate properly.

The HP Digital Entertainment Center supports many different network options, connections, and configurations. You can connect your HP Digital Entertainment Center to a:

- Wireless 802.11b/g network
- Wired Ethernet Port 10/100/1000

You can connect your peripheral devices to work with the HP Digital Entertainment Center through USB or FireWire (IEEE 1394) connectors.

This chapter describes the most typical, and some advanced, options to connect your HP Digital Entertainment Center to the Internet, to a network, and to peripheral devices. Your system may have different components.

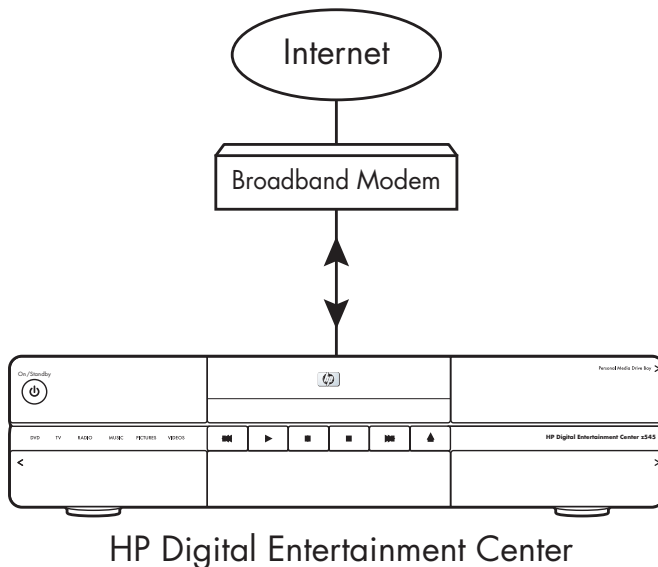

Chapter Contents:

"Peripheral Connection Overview" on page 108

"Typical Network Connections" on page 110

"Connecting the Wireless Network Antenna" on page 111

"Connecting a DSL/Cable Modem" on page 113

"Connecting Through a Router" on page 114

"USB Device Connection" on page 115

"Connecting an HP Personal Media Drive" on page 117



Some peripheral devices are not included with the HP Digital Entertainment Center.





For additional information on connecting network equipment, refer to the *Start Here Booklet* and the hardware and ISP (Internet Service Provider) documentation that came with your network.

Peripheral Connection Overview

Front Panel

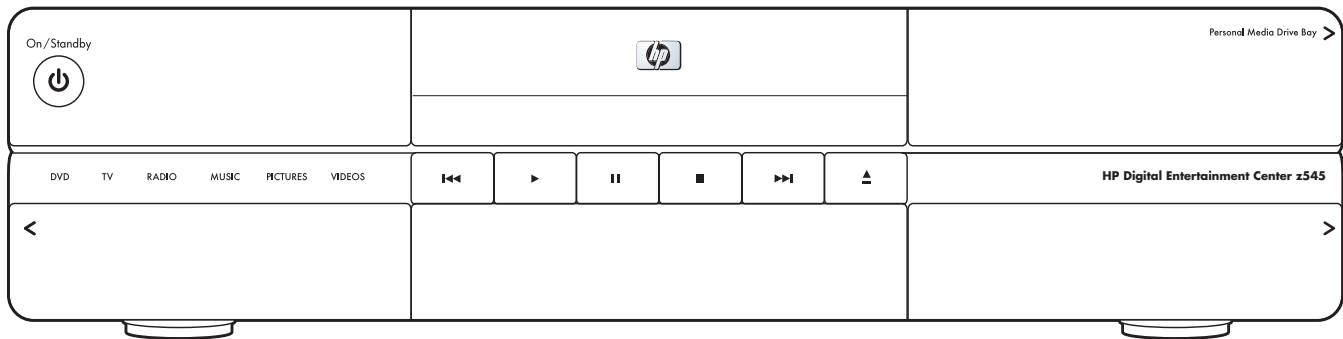
(Location and number of connectors may vary by model.)

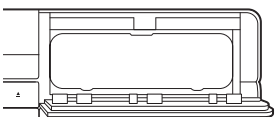
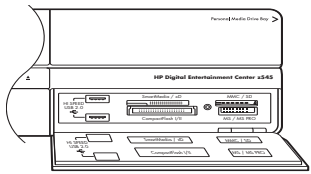
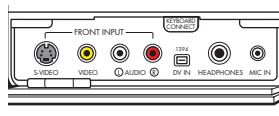



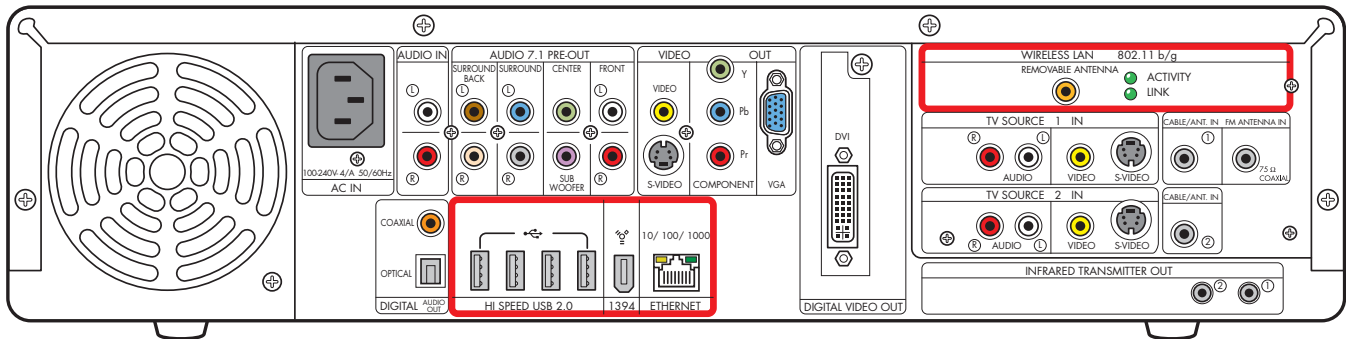

Connector	Name	Description
	Personal Media Drive Bay	Removable hard disk behind top right door
	<i>Behind Right Door</i> 9-1 Memory card readers SmartMedia/xD, MMC/SD, CompactFlash I/II, Micro drive, MS/MS-Pro USB 2.0 (2)	Card readers behind lower right door LED: Green (with media inserted) Off (no media inserted) See "Memory Card Reader" on page 5.
	<i>Behind Left Door</i>	<i>Front button and inputs — see below</i>
	1394	FireWire (IEEE 1394), 4-pin DV input/output for digital video or removable hard disk drive

Back Panel

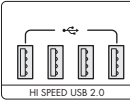
(Location and number of connectors may vary by model.)



Connector	Name	Description
	USB 2.0	High speed USB, 4 ports
	1394	FireWire (IEEE 1394), 6-pin DV input/output for hard disk drive
	Ethernet	RJ-45 10/100/1000
	Wireless LAN Removable Antenna	Coaxial Wireless LAN 802.11 b/g
	LEDs (2)	Activity: Blinks when transmitting/receiving data Link: Solid green when wireless LAN is enabled and connected. Blinks when wireless LAN is scanning.

Typical Network Connections

This section describes how to connect the HP Digital Entertainment Center to the Internet, so you can download the Television Program Guide and surf the Web.

These are only suggested configurations. Your system may be different.

Select the configuration that most closely matches your home system:

Connection	Network configuration	See:
Internet Wireless or Ethernet (10BaseT) Or Fast Ethernet (100BaseT) Or Gigabit Ethernet (1000BaseT)	From an 802.11b/g wireless network	"Connecting the Wireless Network Antenna" on page 111
	From a DSL modem or Cable modem to a router	"Connecting Through a Router" on page 114
	From a DSL modem or Cable modem	"Connecting a DSL/Cable Modem" on page 113

Then see:

"Initial Configuration" on page 121

Connecting the Wireless Network Antenna

You can connect the HP Digital Entertainment Center to a 802.11/b/g wireless network. The transceiver is built into the HP Digital Entertainment Center. An external antenna is supplied with your system. You must connect this antenna to connect to the wireless network. Refer to the *Quick Install Guide* and CD manual included in the accessory box.

Your HP Digital Entertainment Center functions as a Wireless Local Area Network (WLAN), connecting with other wireless product(s) via 802.11 technology. The 802.11/b/g wireless LAN allows you to connect to the Internet from other devices that are compatible with the 802.11 wireless LAN.

You can establish a wireless network using your HP Digital Entertainment Center as a Wireless Access Point or you can use your HP Digital Entertainment Center as a client if you already have a wireless network functioning. You need an existing wireless LAN network with an Internet connection (please consult your ISP for further information).

Wireless Router (802.11b/g)

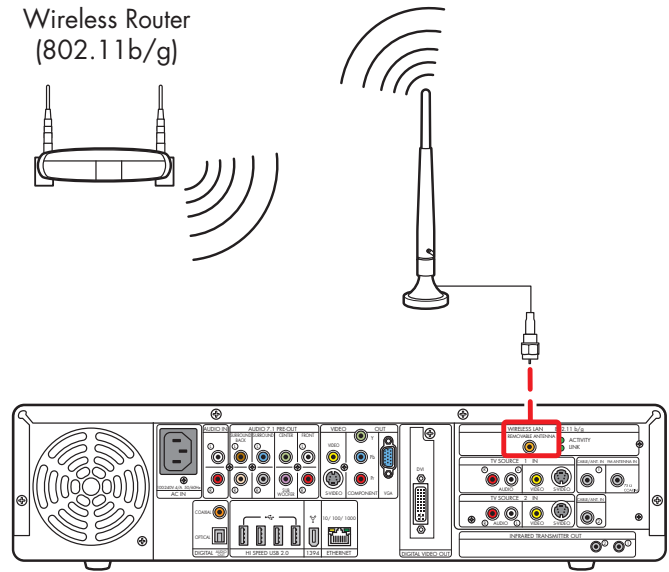

Wireless Router Internet connection

To connect a Wi-Fi antenna to the HP Digital Entertainment Center:

- 1 Screw the included antenna into the Wireless LAN Removable Antenna connector on to the back panel as shown in the following illustration:

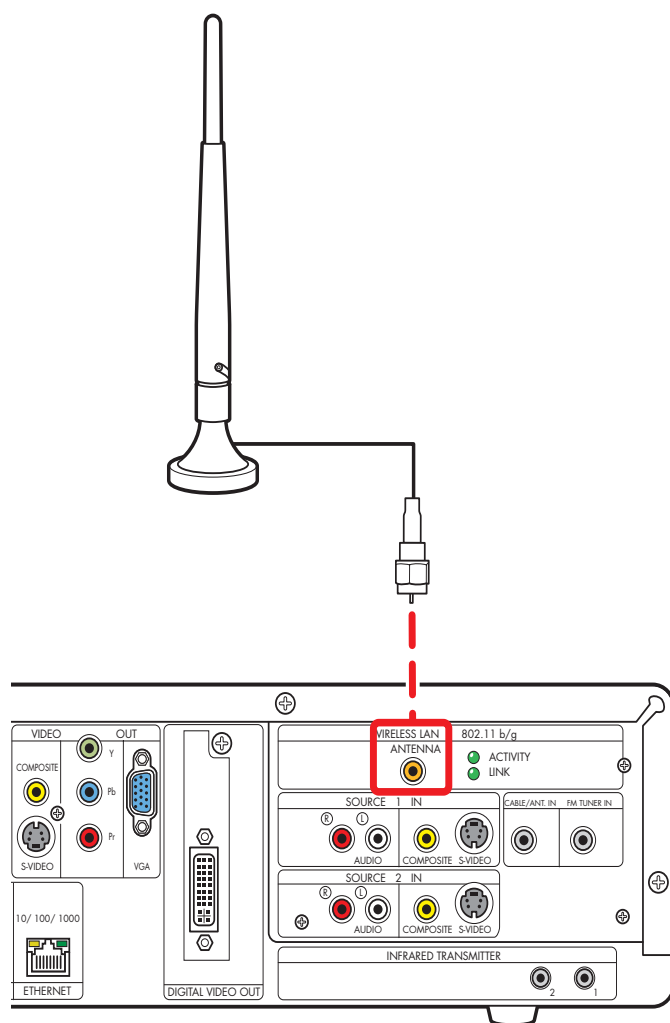

- 2 You may want to move the end of the antenna away from the HP Digital Entertainment Center to improve your signal reception.
- 3 Check the following:
 - a The wireless router is connected to a DSL/cable modem.
 - b The DSL/cable modem is connected to an outside Internet connection.
 - c The wireless router power LED and connect LEDs are on.
 - d The DSL/cable modem power LED and connect LEDs are on.
 - e Your wireless network functions properly.
- 4 Select how you want to set up your network:
 - a If you would like a wireless connection between the HP Digital Entertainment Center and your existing wireless network, establish a wireless network using your HP Digital Entertainment Center as a client. The Media Center setup wizard has a step for this option. This is the Default mode.
 - b If your HP Digital Entertainment Center is connected to the Internet and you would like to wireless-connect other machines to this HP Digital Entertainment Center, establish a wireless network using your HP Digital Entertainment Center as a Wireless Access Point. For more information, refer to the *Quick Install Guide* and CD manual included in the WiFi accessory box.

Connecting a DSL/Cable Modem

You typically connect the HP Digital Entertainment Center to the Internet through a DSL/Cable modem.

Refer to your DSL/cable modem and ISP documentation to establish a connection.

To connect the HP Digital Entertainment Center to the Internet through a DSL or Cable Modem broadband connection:

- 1** Connect an RJ-45 network cable (not provided) from the HP Digital Entertainment Center back panel Ethernet connector to a DSL or Cable modem.
- 2** Check the following:
 - a** The DSL or cable modem is connected to an outside Internet connection.
 - b** The DSL or cable modem power LED and connect LEDs are on.

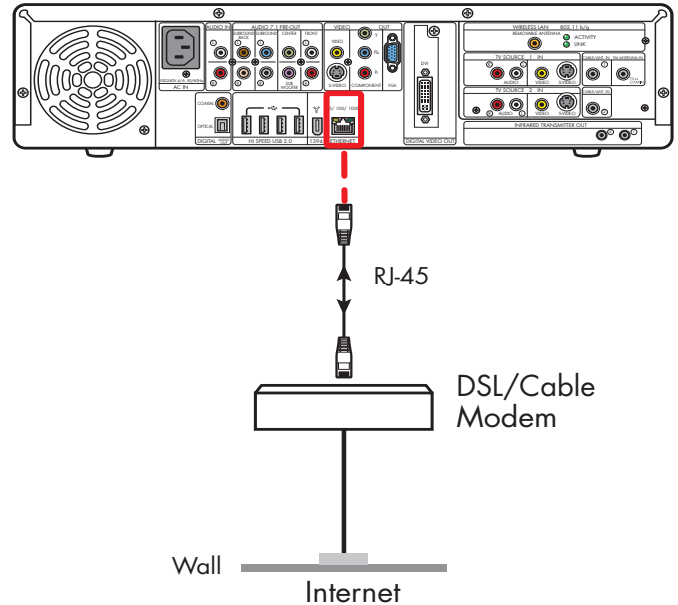

DSL/Cable modem direct Internet connection

Connecting Through a Router

You can connect the HP Digital Entertainment Center to a LAN network and then to a DSL modem or Cable modem. You can use your HP Digital Entertainment Center as a client if you already have a home network functioning.

Refer to your router, DSL/cable modem, and ISP documentation to establish a connection.

To connect to the Internet, through a router and a broadband connection, to the HP Digital Entertainment Center:

- 1 Connect an RJ-45 network cable (not provided) from the HP Digital Entertainment Center back panel Ethernet connector to a 10BaseT, 100BaseT, or 1000BaseT port on the router.
- 2 Check the following:
 - a The router is connected to the DSL/cable modem.
 - b The DSL/cable modem is connected to an outside Internet connection.
 - c The router power LED and connect LEDs are on.
 - d The DSL/cable modem power LED and connect LEDs are on.

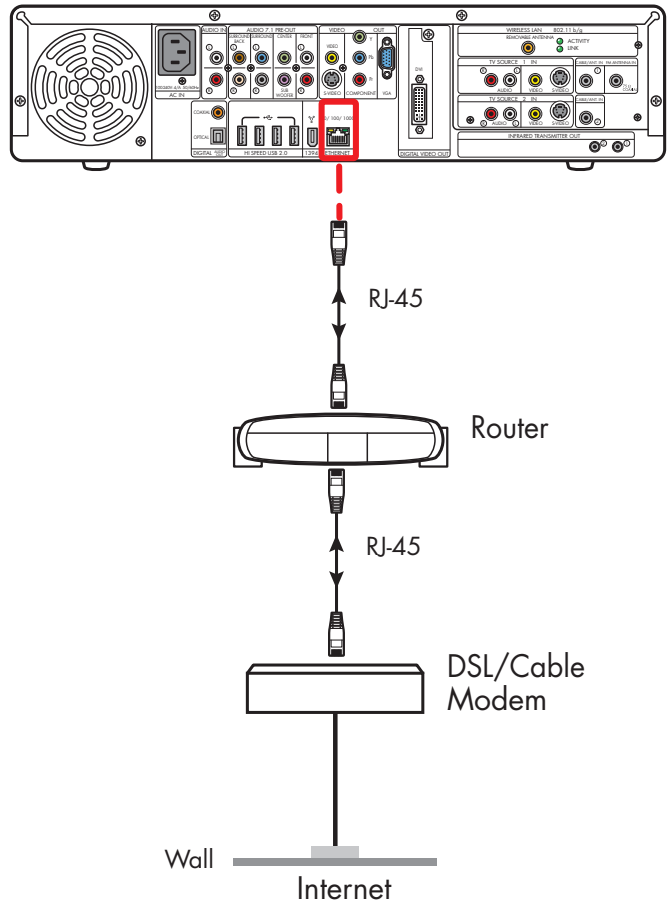

Router Internet connection

USB Device Connection

Digital Still Camera

The following instructions apply only to digital still cameras.

When connecting a digital still camera, use a USB connector on the front or back of the HP Digital Entertainment Center.

To connect a digital still camera:

- 1 Turn on the HP Digital Entertainment Center. Wait for the desktop to appear. Minimize or close Media Center.
- 2 Turn on the digital still camera. See the documentation that came with your camera.
- 3 Connect the camera transfer cable into the camera.
- 4 Connect the camera transfer cable into an open USB connector on the front or back of the HP Digital Entertainment Center. Most digital still cameras use either the USB or FireWire (IEEE 1394) connector.
- 5 A *Found New Hardware* message displays. Wait two or three minutes for the system to make the necessary settings for the new device. When installation is complete, a message displays telling you the camera is ready to use.

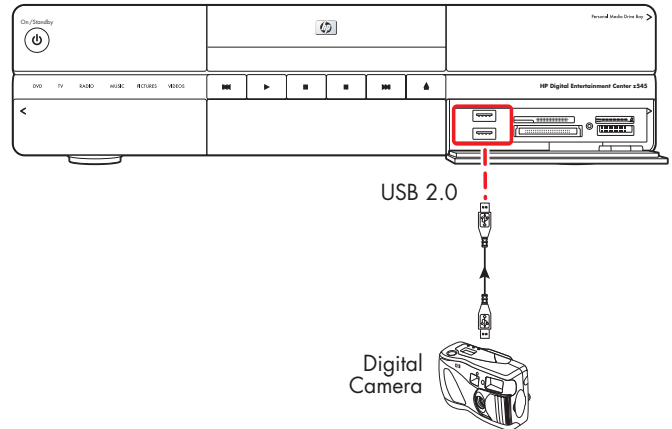

Digital still camera connection (front panel)

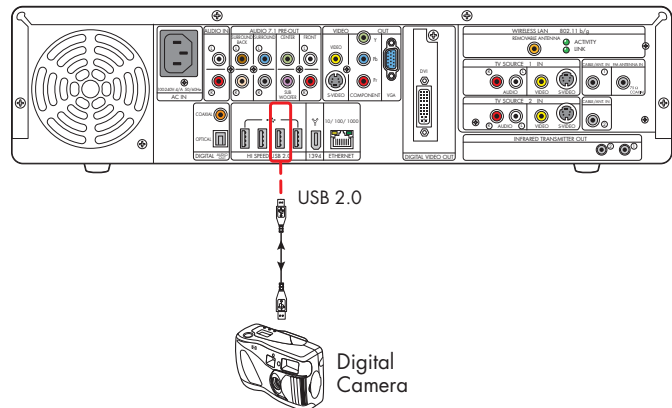

Digital still camera connection (back panel)

Other USB Devices

You can connect other peripheral devices to the front or back of the HP Digital Entertainment Center through USB or FireWire (IEEE 1394) ports.

The following devices can be connected to the HP Digital Entertainment Center USB 2.0 high speed ports:

- iPod
- MP3 player
- USB drive
- External hard drive
- Printer
- Scanner
- Digital video camera
- Digital still camera
- Memory card reader
- PDA (personal digital assistant)
- Handheld computer
- Keyboard
- Mouse

These devices are not included with the HP Digital Entertainment Center. See the documentation that came with your device.

To connect the HP Personal Media Drive to the HP Digital Entertainment Center through a USB, see the documentation that came with the HP Personal Media Drive.

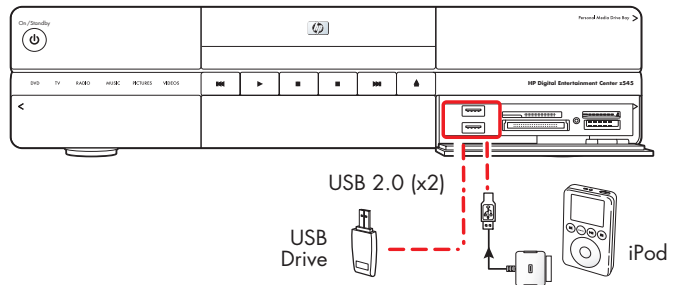

USB device connection (front panel)

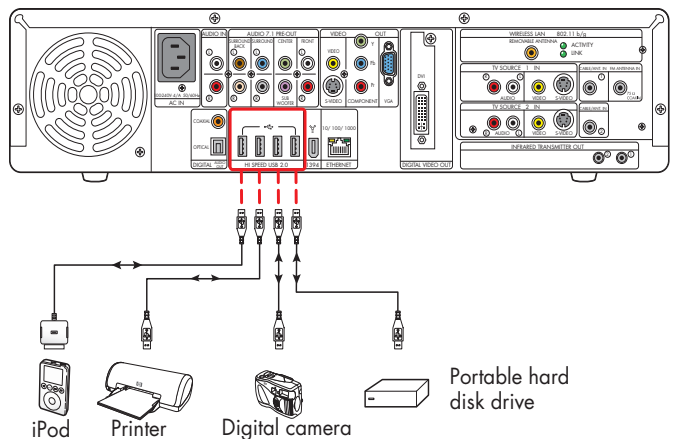

USB device connection (back panel)

Connecting an HP Personal Media Drive

The HP Digital Entertainment Center front panel includes a drive bay that houses the HP Personal Media Drive. The drive bay has an internal USB port and power connector.

The HP Personal Media Drive can also function as an external USB hard disk drive. You must connect an external USB port and power cable.

You can easily insert and remove the drive from the bay without turning off the HP Digital Entertainment Center.

You can use the HP Personal Media Drive without installing the included software. However, HP recommends that you install the software and documentation to have access to additional features.

For more information about installing the software, refer to the documentation that came with the HP Personal Media Drive. For more information about using an HP Personal Media Drive to store and transfer information, refer to the *Media Center Edition 2005 Software Guide*.

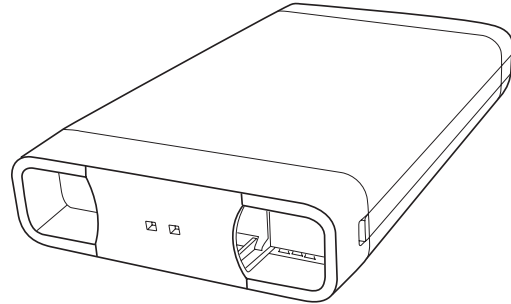

HP Personal Media Drive



Do not move the drive while it is operating, to avoid hardware damage and potential data loss. You can safely remove your drive only after you have completely run the Safely Remove Hardware wizard.

After you have safely disconnected and powered off the drive, handle the drive by the plastic endcaps to avoid touching the aluminum sides if they are hot.

Installing an HP Personal Media Drive

To connect an HP Personal Media Drive to the HP Digital Entertainment Center:

- 1 Install the HP Personal Media Drive software that is included with the drive (select models only).
 - For instructions about installing and using the HP Personal Media Drive software, refer to the documentation that came with your HP Personal Media Drive.
- 2 Open the HP Personal Media Drive bay front panel door.
- 3 Line up the ridges on the bottom of the drive with the two slots on the bottom of the drive bay.
- 4 Slide the drive all the way into the drive bay until the drive is firmly connected to the internal power and USB cables. Do not force the drive into the bay; it should slide easily into the bay.
- 5 If the HP Digital Entertainment Center is turned on, the blue power LED on the front of the drive lights up when the drive is inserted correctly.

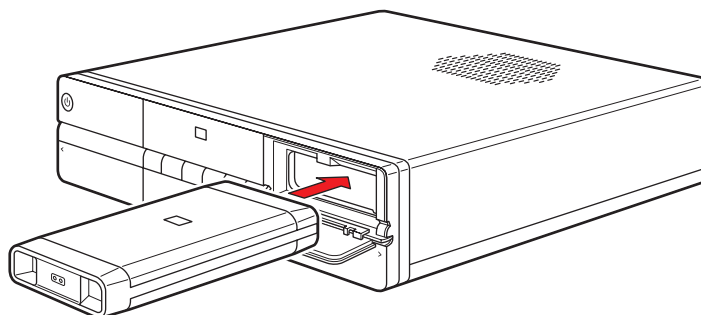

HP Personal Media Drive installation

Running the HP Personal Media Drive Utility

To transfer files from your primary hard drive to your HP Personal Media Drive, you must first run the utility for each installed Media Drive to access the drive within Media Center:

- 1 Press Media Center on the remote control.

You can also click **Start** on the taskbar, and select **Media Center**.



- 2 Click **More Programs**, **HP Settings**, and then **HP Media Drive**.
- 3 Connect the HP Personal Media Drive.
- 4 Follow the onscreen instructions.

For instructions about using the HP Personal Media Drive software, refer to the documentation that came with your HP Personal Media Drive.

Disconnecting an HP Personal Media Drive

You can safely remove the HP Personal Media Drive when both the amber activity and blue power LEDs are off.



When your HP Digital Entertainment Center is in standby mode (reduced power state), the drive turns off.

To disconnect your HP Personal Drive safely:

- 1 Close Media Center and all other programs that may be accessing your HP Personal Media Drive.
- 2 Double-click the **Safely Remove Hardware** icon in the system tray at the bottom of the desktop. If this icon is hidden, click the arrows on the taskbar to display it. The Safely Remove Hardware window opens. 
- 3 Double-click **USB Mass Storage Device** to locate your HP Personal Media Drive. USB Mass Storage Device may be listed twice. One may contain a memory card reader or other mass storage drive.
- 4 Select the **HP Personal Media Drive**, and then click **OK**. This name of the drive may appear as *Generic Volume*, followed by the assigned drive letter. A *Safe to Remove Hardware* message appears in the system tray at the bottom of your desktop letting you know that the device is safe to disconnect.
- 5 Click **Close**.

6 Open the HP Personal Media Drive bay front panel door.

7 Disconnect the drive from the HP Digital Entertainment Center.

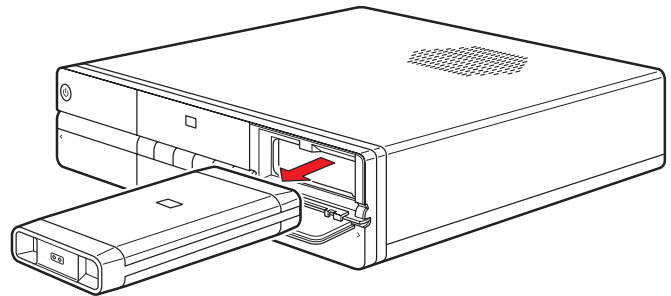

Disconnecting the HP Personal Media Drive



To avoid hardware damage and data loss, always disconnect the drive safely, when it is not active. When the amber LED is blinking, the drive is active, saving or transferring data.

Initial Configuration

This chapter describes how to set up your HP Digital Entertainment Center software, including how to configure the HP Digital Entertainment Center for proper operation.

When you complete the procedures in this chapter, you can use your HP Digital Entertainment Center in your home entertainment center. Refer to the *Media Center Edition 2005 Software Guide*.



You should only perform the procedures in this chapter after all cables have been connected.



Make sure you have followed all safety instructions for your HP Digital Entertainment Center, especially the important AC Power information.

See "Safety Information" on page 19.

Chapter Contents:

"Starting the HP Digital Entertainment Center for the First Time" on page 122

- "Installing the Keyboard Batteries (Initial)" on page 122
- "Initial Start Up" on page 122
- "Syncing the Keyboard" on page 123

"Windows Welcome" on page 125

"Media Center First-Run" on page 126

"Configuring Audio" on page 130

"Configuring Video" on page 134

"Configuring the Keyboard Buttons" on page 138

Starting the HP Digital Entertainment Center for the First Time

Installing the Keyboard Batteries (Initial)

The keyboard comes with batteries pre-installed. The batteries are fresh from the factory.

- 1 Turn the keyboard over.
- 2 Pull the tab.



Use only AA alkaline batteries in the keyboard.

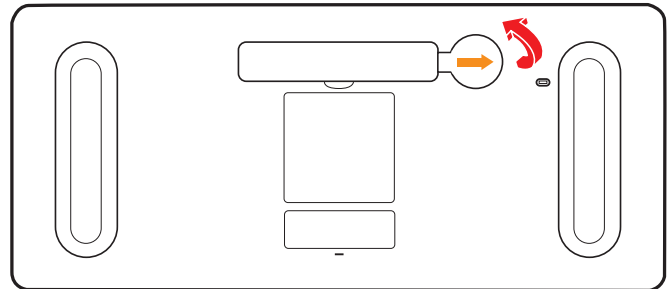

Initial Start Up

After you have connected the equipment, you are ready to turn on the system.

- 1 Make sure the video and audio cables are connected before you turn on the TV and the HP Digital Entertainment Center.
- 2 Apply power to all connected system equipment, such as TVs, set-top-boxes, and AV receivers.



Set the volume to mid-level on the AV receiver on the TV.

- 3 Plug the HP Digital Entertainment Center AC power cable into a wall outlet.
 - Use a surge protector to prevent power surges or voltage spikes.

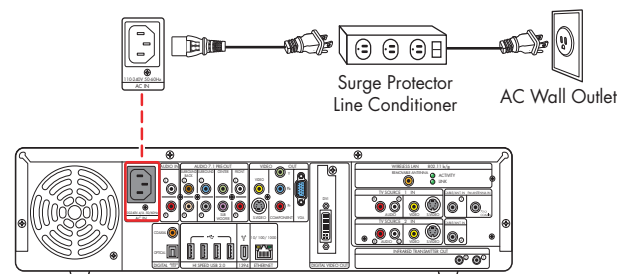

- 4 Press the power button  on the front of the HP Digital Entertainment Center. The system starts.

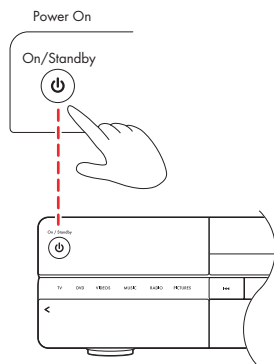

- 5 See "Syncing the Keyboard" on page 123.

The display on the TV screen may not be optimized until after you set the display settings.



Make sure you have followed all safety instructions for your HP Digital Entertainment Center, especially the important AC Power information.

See "Safety Information" on page 19.

Syncing the Keyboard

Test the keyboard after the operating system is loaded. Move the trackball to see if the cursor moves.

If the keyboard does not operate, you must synchronize the keyboard with the HP Digital Entertainment Center.

To sync the keyboard:

- 1 After you have made all connections and have performed the initial startup procedure, make sure the HP Digital Entertainment Center is turned on.
- 2 Briefly press the Keyboard Connect button on the HP Digital Entertainment Center front panel, behind the left door. The button will flash, indicating the system is ready to connect (sync) with the keyboard.

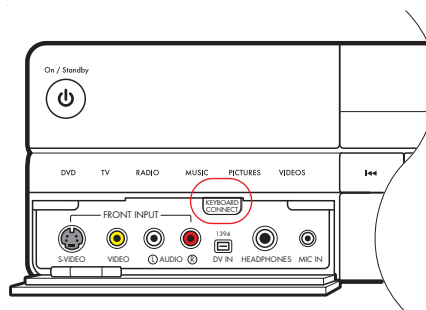

- 3** Press the red connect button once on the bottom of the keyboard. The front panel Keyboard Connect button flashes and stops, indicating a successful sync.

Important: If you press the button twice, you will need to repeat steps 1 through 4.

- 4** Test the keyboard. Move the trackball and see if the cursor moves.

- 5** If the keyboard does not operate:

- a** Check the batteries.
- b** Repeat steps 1 through 4.

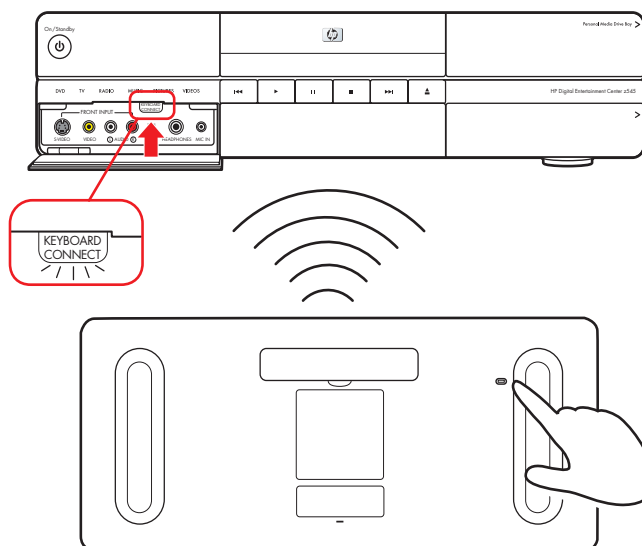

Windows Welcome

The system starts and displays the initial Microsoft Windows setup screen for the first turn-on only. You will need a mouse and keyboard to navigate the screens.

To setup Windows for the first time:

- 1 Follow the onscreen instructions for the initial Microsoft Windows setup.
- 2 Click **Next** to set up your system.
- 3 Select your country/region and language in System Settings. Change is optional. Click **Next**.
- 4 Select your Time Zone. Change is optional. Click **Next**.
- 5 Accept the End Users License Agreement. Click **Next**.
- 6 Select Automatic Updates. Click **Next**.
- 7 Name your system. Click **Next**.
- 8 Select **Finish**.
- 9 A countdown displays.
 - a After the countdown the screen goes blank.
 - b **Do not turn off your system** during this one time set-up process. This takes approximately eight to ten minutes.
- 10 Windows restarts automatically.
- 11 After the system restarts, you will begin the Media Center first run. See "Media Center First-Run" on page 126.

Media Center First-Run

The initial Media Center setup wizard consists of required setup and the optional setup.

Required Set-up

The system displays the initial Media Center setup wizard for the first power-up or until the Media Center setup is completed. The wizard includes steps for your network or broadband connections. Connect the HP Digital Entertainment Center to your wired network or broadband connections prior to power-on.



When Media Center is open, you can press F1 on the keyboard to open Media Center Help.

To set up Media Center for the first time:

- 1 Follow the onscreen instructions for the initial Media Center startup wizard. These instructions include choosing:
 - How Media Center connects to the Internet.
 - To join a wireless network, if you have one.
 - To join an existing (wired) network, if you have one.
- 2 The wizard sets up the required components. To continue, set up optional components as required. See "Optional Set-up" on page 127.

Optional Set-up

This procedure for optional components within the Media Center wizard can be done later; you can define or change these settings using the Media Center settings.

In this portion of the Media Center wizard, you will:

- Configure tuners, TV signal, and Television Program Guide information.
- Select and adjust Media Center display settings.
- Set up speakers.
- Teach the HP Digital Entertainment Center to control your cable TV or satellite receiver set-top-box.

To set up optional components in Media Center:

- 1** Follow the onscreen instructions for the Media Center optional components startup wizard.
- 2** Confirm your country/region.
- 3** Set up the TV signal, manually or automatically. Make sure a TV source is connected. The wizard scans for signals if you select automatic. It also sets up a set-top-box.
- 4** Set up and download the Television Program Guide. You need your zip or postal code.
- 5** Choose and, if needed, adjust the display settings.
- 6** Choose the number of speakers you have. You can also test the speakers.
- 7** If you selected 5.1 or 7.1 speakers, or if you are using SPDIF (digital), you must set the DVD player. See "Configuring audio for the DVD Player" on page 133.



When Media Center is open, you can press F1 on the keyboard to open Media Center Help.

If Your Connections Don't Work

You can use Media Center wizards to walk you through the connection process:

- 1 Press Media Center on the remote control.



You can also click **Start** on the taskbar, and select **Media Center**.

- 2 Click **Settings**.

- 3 Click one of the following topics:

- a General
- b TV
- c Pictures

- d Music

- e DVD

- f Messenger and Caller ID

- g Radio

- h Help

- 4 Follow the onscreen instructions.

- 5 If you cannot connect to the Internet, the wizard displays automatically.

Register with HP

To register with HP to receive changes, updates, and support:

- 1 Press Media Center on the remote control.



You can also click **Start** on the taskbar, and select **Media Center**.

- 2 Click **More Programs**, **HP Support**, and then **Register Now**.

- 3 Follow onscreen instructions, using the keyboard and trackball.

You can also register with HP in the following ways:

- Double-click the registration icon on your desktop, and follow onscreen instructions.
- Register online at:
<http://register.hp.com>

Set up Virus Protection

You should use virus protection if you connect to the Internet. Refer to the *Media Center Edition 2005 Software Guide* to set up the virus protection software.

Adjusting the Front Panel Display Brightness

You can adjust the brightness of the HP Digital Entertainment Center front panel display.

This setting does not control the brightness of the Power button or Media Center mode status LEDs.

To adjust the front panel display brightness:

- 1 Press Media Center on the remote control.



You can also click **Start** on the taskbar, and select **Media Center**.

- 2 Click **More Programs**, **HP Settings**, and then **Front Panel**.

- 3 Change the front panel brightness.

- 4 Set adjustment for manual or automatic. Automatic changes the display brightness based on room light level.

- 5 Click **Save**.

Configuring Audio

Connecting Headphones

Your HP Digital Entertainment Center comes with a headphones connector (1/4-inch [6.5 mm]) on the front panel. The headphones connector is labeled with a headphones icon.

You can connect a mini plug adapter into the 1/4-inch (6.5 mm) plug to use 1/8-inch (3.5 mm) mini headphones.

The Audio Out speakers are muted when you plug in the headphones, but SPDIF does not mute.

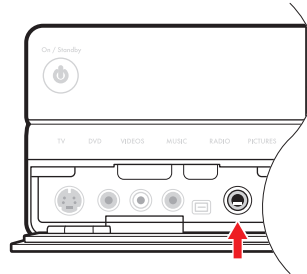

Connecting a Microphone

Your HP Digital Entertainment Center has a microphone connector on the front panel.

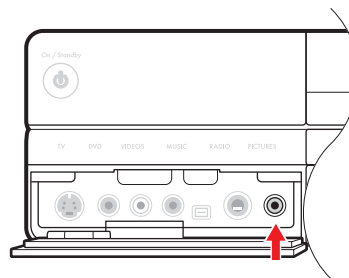

Selecting recording devices

To select a sound recording device:

- 1 Click **Start** on the taskbar.
- 2 Choose **Control Panel**.
- 3 Click **Sounds and Audio Devices** (or **Sounds, Speech, and Audio Devices**). The Sounds and Audio Devices window opens.

- 4 Click the **Audio** tab. The window opens.

This window is easier to read on a monitor. You can lower the display resolution to read the window. You will need the keyboard and mouse.



Audio distortion may occur if recording volume is set too high.

- 5** In the Sound Recording area, click the **Volume** button, and then choose the source for sound recording.
- 6** Click **OK**.
- 7** Close the window.

Adjusting the Volume

To adjust speaker volume, use the:

- Remote control.
- TV.
- AV receiver.
- Buttons on the keyboard.
- Volume knob on the speakers.
- Volume knob on the subwoofer.
- Volume knob on the monitor (if connected).
- Volume controls within a program, such as the volume buttons on the Media Center navigation bar or on the remote control.
- Volume icon on the taskbar. Double-click and adjust the volume.



Ensure that the mute box is *not* checked.

Some applications may play back at low volume, even when the volume knob is turned to the maximum position. If this is the case, double-click the **Volume** icon on the taskbar and increase the volume.

Locating the volume icon

If you do not see the Volume icon on the taskbar:

- 1** Click **Start**, and then **Control Panel**. Click **Sounds, Speech, and Audio Devices**, if it is present.
- 2** Double-click **Sounds and Audio Devices**. The Sounds and Audio Devices Properties window opens.

This window is easier to read on a monitor. You can lower the display resolution to read the window. You will need the keyboard and mouse.
- 3** Click the **Volume** tab. Place a check in the *Place volume icon in the taskbar* check box.
- 4** Click **Apply**, and then click **OK**. The Volume icon appears in the taskbar.

Configuring Audio Output

You must adjust the audio settings in two places after you have installed and connected the HP Digital Entertainment Center to your audio system.

Configure both the Media Center speaker settings and audio for the DVD player.

The following table shows which procedures to perform for your audio system. If you set up speakers using the Media Center Optional Settings wizard, then set up the audio for the DVD player only.

Media Center speaker settings (TV Audio)	DVD audio setting	Procedure
2 <i>(default)</i>	2 speakers; Dolby Surround Compatible <i>(default)</i>	Default, no audio output configuration required.
5.1	5.1	Change Settings in "Configuring audio for Media Center" on page 133 and "Configuring audio for the DVD Player" on page 133.
7.1	7.1	Change Settings in "Configuring audio for Media Center" on page 133 and "Configuring audio for the DVD Player" on page 133.
Digital Audio SPDIF on <i>(default)</i>	Digital Audio SPDIF off <i>(default)</i>	Change Settings in "Configuring audio for the DVD Player" on page 133. If you use digital audio, the Media Center SPDIF default setting is on, but the DVD Player SPDIF default setting is OFF. You must change the DVD SPDIF default setting to ON to hear all channels in DVD digital audio.

Configuring audio for Media Center

To configure multichannel audio output for Media Center audio:

- 1 Press Media Center on the remote control.



You can also click **Start** on the taskbar, and select **Media Center**.

- 2 Click **Settings, General, Media Center Setup**, and then **Setup your Speakers**. The Speaker Setup screen displays.

- 3 Click **Next**.

- 4 Under **Specify how many speakers you have**, Select the speaker number that matches your system. For example, select **5.1**. Click **Next**.

- 5 Select **Test**. If you hear tones from all your speakers, click **Next**. If you do not hear tones from all your speakers, follow the onscreen instructions.

- 6 Click **Finish**.



If your speaker configuration is not displayed, click the Sound Effect speaker icon in the desktop system tray.

Configuring audio for the DVD Player

To configure multichannel audio output for the Media Center DVD playback:

- 1 Press Media Center on the remote control.



You can also click **Start** on the taskbar, and select **Media Center**.

- 2 Click **Settings, DVD, Audio**, and then **Configuration**.

- 3 Set sound output to match your speaker system. For example, select **5.1**. If you have digital audio, select S/PDIF.

- 4 Click **Save**.

Configuring Video

Configuring Video Output

You can configure your HP Digital Entertainment Center video for dual display. For instance, you can view the screen on your TV and your monitor if both are connected. You can also set up additional displays. See "Video Out to TV and Monitor" on page 71 to connect your TV and monitor.

Video drivers change periodically; check HP Support for updates.



Your TV and monitor must be connected to the HP Digital Entertainment Center before turning on the power to see the display on two screens.

Dual screen

The HP Digital Entertainment Center can connect more than one display device (CRT monitor, flat panel monitor, TV, and so on) to the HP Digital Entertainment Center.

The display defaults to the monitor on power up if you have two displays connected. You must set up the TV manually.

See "Viewing the screen image on a second display" on page 135.

Changing screens

Once you have configured for dual screen, you can quickly change where the HP Digital Entertainment Center desktop appears by pressing Alt+F5. (Press the Alt key and the F5 key on the keyboard at the same time.)

Each time you press the Alt+F5 key combination, the HP Digital Entertainment Center desktop appears on the next device. If Alt+F5 does not work, restart the HP Digital Entertainment Center and try again.

Viewing the screen image on a second display

To view your HP Digital Entertainment Center screen image on a second TV or monitor:

- 1 Make sure the video and audio cables are connected before you turn on the TV and the HP Digital Entertainment Center.
- 2 Turn on the TV. Press the Video/TV button on the TV remote control to select the Video input.
- 3 Turn on the HP Digital Entertainment Center.
- 4 Press Media Center on the remote control. 

You can also click **Start** on the taskbar, and select **Media Center**.
- 5 Click **More Programs**, **HP Settings**, and then **Resolution**. The Display Settings window opens.



You can also click on the Display Settings shortcut on the desktop, or right-click an empty area of the desktop and choose Properties. The Display Properties window opens. Click the Settings tab.

- 6 Click **Advanced** button. The Display Properties window opens.
- 7 Click **Settings**.
- 8 Click the **Advanced** button.
- 9 Click the **Displays** tab.

The monitors and TVs are shown. The upper-left corner of each display icon is a button and a status indicator. A red corner indicates an inactive display; a green corner indicates an active display.

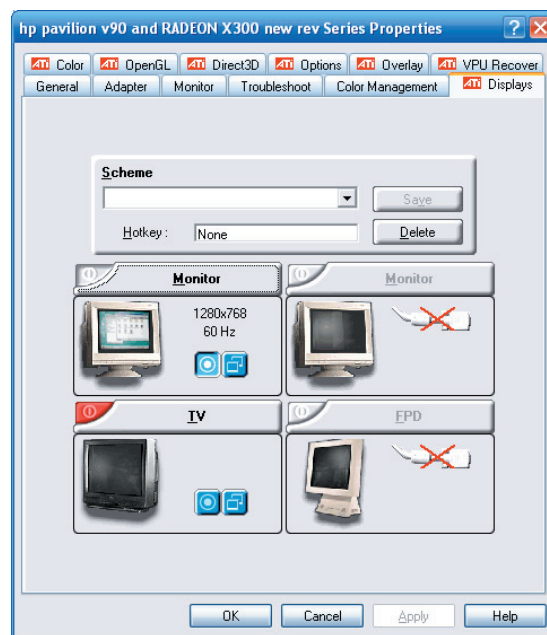

- 10 Select the screen.
 - Dual Screen: To view the display on your monitor and TV simultaneously, click the upper-left corner of the TV icon. It becomes green. Both the monitor and the TV should have green corners.

Or

 - Single Screen: To view the display on just the TV, click the TV corner. It becomes green. Then click the monitor corner so it is red.
- 11 Click **Apply**.
- 12 When the HP Digital Entertainment Center image appears on the TV screen, click **Yes** to keep the setting. You have 15 seconds to accept this new setting before it reverts to the previous setting.
- 13 Click the **OK** button to save changes. Click **OK** again to close the Display Properties window.

Disabling the dual screen option

When you want to disconnect the TV from the HP Digital Entertainment Center, you may need to disable the TV option to return your HP Digital Entertainment Center display to its original resolution.

To disable the TV or monitor dual screen option and view your HP Digital Entertainment Center image on the original display:

- 1 Press Media Center on the remote control.



You can also click **Start** on the taskbar, and select **Media Center**.

- 2 Click **More Programs**, **HP Settings**, and then **Resolution**.
- 3 Click **OK** at the prompt to open the display settings window.
- 4 Click the **Advanced** button.
- 5 Click **Advanced** button. The Display Properties window opens.
- 6 Click the **Displays** tab.

The monitors and TVs are shown. The upper-left corner of each display icon is a button and a status indicator. A red corner indicates an inactive display; a green corner indicates an active display.

This window is easier to read on a monitor. You can lower the display resolution to read the window. You will need the keyboard and mouse.

- 7 Click the upper-left corner of the TV icon so it is red, and then click the upper-left corner of the monitor icon so it is green. Click the **Apply** button.
- 8 When the HP Digital Entertainment Center image appears on the TV screen, click **Yes** to keep the setting. You have 15 seconds to accept this new setting before it reverts to the previous setting.
- 9 Click the **OK** button to save changes, and then click **OK** again to close the Display Properties window.

Disconnecting the TV

To disconnect the TV:

- 1 Disable the TV option. See "Disabling the dual screen option" on page 136.
- 2 Turn off the TV and the HP Digital Entertainment Center.
- 3 Remove the video cable from the HP Digital Entertainment Center Video Out and the TV in.

Adjusting the Desktop Display

Some tasks on the HP Digital Entertainment Center require that you leave Media Center and use the Windows XP desktop. Because Windows XP is not specifically designed for TV, some messages and dialogs may be difficult to read on some TVs.

Lowering the display resolution can make messages and dialogs easier to read by enlarging the text. This utility has three common resolutions. This utility does not change the resolution within Media Center, but raises or lowers the resolution of the Windows XP desktop display.

To adjust the Windows desktop display resolution:

- 1 Press Media Center on the remote control.  You can also click **Start** on the taskbar, and select **Media Center**.
- 2 Click **More Programs**, **HP Settings**, and then **Resolution**.
- 3 Click **OK**.
- 4 Choose your display resolution: High, Medium, or Low.
- 5 Select advanced display settings if the resolution provided in the utility still cannot display on your TV well:
 - a Click the **Advanced** button. The Windows Display Properties displays.
 - b At the Settings tab, select the resolution that provides the best viewing.

This window is easier to read on a monitor. You can lower the display resolution to read the window. You will need the keyboard and mouse.

- 6 Click **Apply**.
- 7 Click **Exit**.

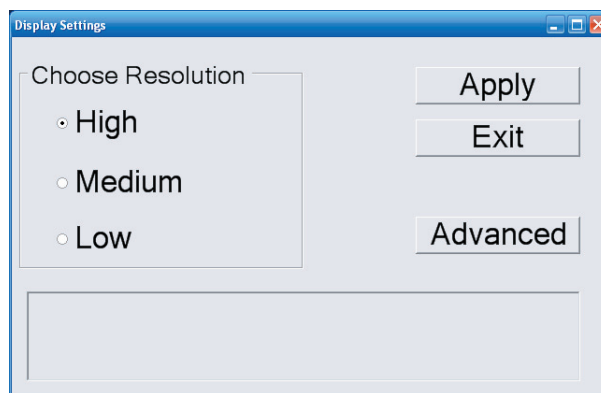

To open the Display Properties window from the Windows desktop:

- Right click on the desktop. Select **Properties**.
- Or
- Click **Start**, **Control Panel**, **Appearance**, and then click **Display** (recommended for monitor display).

Configuring the Keyboard Buttons

You can configure some of your HP Digital Entertainment Center shortcut keyboard buttons.

- 1 Click **Start** on the taskbar, choose **Control Panel**, and then click **Printers and Other Hardware**, if it is present.
 - 2 Double-click **Keyboard**.
 - 3 In the Keyboard Properties window that opens, click the **Buttons** tab.
 - 4 Double-click the button you want to change.
 - 5 Choose the button capability from the drop-down list. Enter the Display label and Address information. (For a Web site, enter the complete Web site URL in the Address box. Example: `http://www.hp.com/support`)
 - 6 Click **OK**.
 - 7 On the Buttons tab, click **Apply**. Repeat steps 4 through 6 for other buttons.
 - 8 Click **OK** when you are finished.
-

Transferring Old PC Information to Your New HP Digital Entertainment Center

See the built-in Microsoft Windows Help and Support Center; search for *transfer wizard* and select the overview article, *Files and Settings Transfer Wizard overview*. This information describes a Microsoft solution for moving your files to your new HP Digital Entertainment Center.

Installing Software

After you turn on the HP Digital Entertainment Center the first time and then restart it, you can install any software programs that came on CDs or DVDs included in the HP Digital Entertainment Center box (select models only).

You may wish to install additional software programs or hardware devices on your HP Digital Entertainment Center. Restart the HP Digital Entertainment Center after installation.

Choose software that is compatible with your HP Digital Entertainment Center; check the operating system, memory, and other requirements listed for the new software for compatibility with your HP Digital Entertainment Center.

Install the new software according to the directions provided by the software manufacturer. Check the manufacturer's documentation or customer service information for help if you need it.

After you have completed registering, install any software programs that may have come on CDs or DVDs included in the HP Digital Entertainment Center box.

Utility Programs

HP Settings

HP provides special utility programs in the HP Digital Entertainment Center Media Center that configure the desktop display, adjust front panel brightness, and setup the HP Personal Media Drive.

To use Media Center utility programs:

- 1 Press Media Center on the remote control.



You can also click **Start** on the taskbar, and select **Media Center**.

- 2 Click **More Programs**, and then **HP Settings**.
- 3 Select a program or folder:
 - Resolution
 - Front Panel
 - HP Media Drive

System Utilities

HP provides special utility programs in the HP Digital Entertainment Center Help & Tools folder that display support information and initiate application or system recovery.

To use utility programs:

- 1 Click **Start**, choose **All Programs**, and then **HP Digital Entertainment Center Help & Tools**.
 - 2 Select a program or folder:
 - Updates from HP
 - HP support Information
 - PC Doctor
 - Safety and Comfort Guide
 - Software Repair Wizard
-

Troubleshooting

This section contains possible solutions for some problems you may be experiencing with the HP Digital Entertainment Center.

Chapter Contents:

Solving audio problems, see "Audio" on page 142.

Solving video problems, see "Video" on page 143.

Other sources of information, see "Getting Help" on page 151.

Problems and Solutions

Audio

Find the description that most closely matches your audio problem and try the corresponding solution.

Problem	Solution
I don't have sound from my speakers.	<ul style="list-style-type: none"> ■ Verify sound cable connections. ■ Check volume and mute settings. See "Adjusting the Volume" on page 131. ■ Reconfigure the software for surround sound. See "Configuring Audio Output" on page 132. ■ Reinstall the sound card drivers by using Application Recovery. See the <i>Warranty and Support Guide</i> that came with your HP Digital Entertainment Center. ■ Use active, powered speakers, or speakers with an amplifier.
I have low volume sound from my speakers.	<ul style="list-style-type: none"> ■ Check volume and mute settings. See "Adjusting the Volume" on page 131. ■ Some programs may result in low volume, even when the volume knob within the program is turned to the maximum position. If this is the case, double-click the Volume icon on the taskbar and increase volume.
The HP Digital Entertainment Center doesn't make any sound.	<ul style="list-style-type: none"> ■ Check that the AV Receiver or powered speakers are turned on and are set to the proper input. ■ Increase the volume on the remote control. ■ Press the Mute button on the keyboard or on the remote control to see if the Mute feature is turned on. ■ Use the keyboard controls to increase the volume. ■ Click the Volume icon on the Windows taskbar. Increase the volume, and make sure the Mute box is not checked. ■ Double-click the Volume icon on the Windows taskbar. The Play Control window opens. Make sure none of the Mute check boxes are selected. Adjust the volume slide bars to increase volume. ■ If your speakers have a power button, check whether it is turned on and whether the power supply is connected to the power source. ■ Check the speaker connections. ■ Remove any connected headphones.
Surround sound isn't working.	See "Configuring Audio Output" on page 132.

Video

Find the description that most closely matches your problem and try the corresponding solution.

Problem	Solution
I am using a TV with the HP Digital Entertainment Center, but I cannot see anything.	<ul style="list-style-type: none">■ Check that the correct input source is selected on the TV.■ Check that the TV is connected to the HP Digital Entertainment Center. See "Video Out to TV" on page 66.■ Check that the TV Out image is enabled. See "Configuring Video" on page 134.
I cannot see anything on the TV. I can hear it, though.	<ul style="list-style-type: none">■ If the Video Output S-video and composite connections are not connected to a TV or Video Input when the HP Digital Entertainment Center is turned on, the S-video and composite jacks will turn off automatically. You must turn off, by pressing and holding down the power button for four seconds, and restart your HP Digital Entertainment Center to ensure Video Out connection to your TV or AV receiver.■ Check your input switches.
The HP Digital Entertainment Center doesn't recognize my digital video camera.	See "Recognizing the camera" on page 105.

Problem	Solution
<p>My remote control doesn't work.</p>	<ul style="list-style-type: none"> ■ Check that the remote control indicator light on the remote lights up when you press a button. If it does not, replace the batteries. ■ Make sure that the batteries for the remote control are charged and installed correctly. ■ Make sure the front of the remote sensor on the HP Digital Entertainment Center is not blocked (behind display window). ■ Point the remote control at the HP Digital Entertainment Center (not at the TV) within a 45-degree angle range, and less than 26 feet (8 meters) away. ■ If a pressed key repeats itself (or sticks), try altering the lighting conditions in the room or moving the location of the HP Digital Entertainment Center, if this continues. ■ Press the Enter button on the remote control after changing a channel. ■ Point the remote control toward the remote sensor and press a button. A faint red light should appear on the remote sensor. If the light appears, then the problem is probably in the Media Center software. Close Media Center, restart the HP Digital Entertainment Center, and then open Media Center again. ■ If the remote control works in Media Center but not when changing channels, you need to reconfigure the Media Center software settings for the cable set-top-box or satellite receiver. Refer to the <i>Media Center Edition 2005 Software Guide</i>.
<p>My remote sensor is not receiving a signal from the remote control.</p>	<p>If a faint red light does not appear when you point the remote control at the front panel remote sensor and press a button, try the following:</p> <ul style="list-style-type: none"> ■ Check that the remote control indicator light on the remote lights up when you press a button. If it does not, replace the batteries. <p>Or</p> <ol style="list-style-type: none"> 1 Click Start on the desktop, right-click My Computer, and then select Properties. 2 Click the Hardware tab, and then click Device Manager. 3 Click the plus (+) sign next to Universal Serial Bus Controllers. 4 If the <i>eHome Infrared Receiver</i> is listed under Universal Serial Bus Controllers, Windows is properly detecting the IR Receiver. If it is not listed, go to the next step. 5 Turn off the HP Digital Entertainment Center. Remove all external USB devices. Remove the power cord for 30 seconds. Then reconnect external devices and power. Repeat steps 1–4.

System

Find the description that most closely matches your problem and try the corresponding solution.

Problem	Solution
My HP Digital Entertainment Center won't turn on at all.	<ul style="list-style-type: none">■ When you press the On button on the front of the HP Digital Entertainment Center, the following events should happen:<ul style="list-style-type: none">a The HP power button should light and the front display lights up.b The hard disk drive and fans spin.c The HP Digital Entertainment Center makes one beep, indicating it is operating properly.■ If the HP Digital Entertainment Center doesn't go through the previous procedure, check the following:<ul style="list-style-type: none">a The power cord and all cables are securely plugged into the HP Digital Entertainment Center.b The power cord is plugged into a grounded outlet. Check to see whether the outlet works by plugging another item into it.c Look inside the rear fan. If you see a green LED, then AC power is available.d The TV or monitor is connected to the HP Digital Entertainment Center, plugged in, and turned on.e Make sure that the HP Digital Entertainment Center is not too hot, and that vents are not blocked.
I installed a new printer or other device, and it won't work.	<ul style="list-style-type: none">■ Be sure that you installed the device drivers that came with the new device.■ You may need an updated driver for Windows XP. For non-HP peripherals, contact the vendor directly. For HP peripherals, visit the HP Web site. Refer to the <i>Warranty and Support Guide</i> for details.

Problem	Solution
<p data-bbox="147 392 444 523">The HP Digital Entertainment Center (or part of it) doesn't seem to be working.</p> <div data-bbox="180 562 451 1000" style="background-color: #92d050; border-radius: 10px; padding: 10px; text-align: center;">  <p data-bbox="191 678 399 967">Using the On button to reset the HP Digital Entertainment Center is not recommended and should be used only as a last resort.</p> </div>	<ul style="list-style-type: none"> <li data-bbox="527 392 1451 484">■ When the HP Digital Entertainment Center is in standby mode (the On button power indicator light is solid amber). Press the Standby button on the keyboard or the Standby button on the remote control to turn on the unit. <li data-bbox="527 498 1451 562">■ Make sure the keyboard syncs with the HP Digital Entertainment Center. See "Syncing the Keyboard" on page 123. <li data-bbox="527 575 1266 606">■ Try restarting the HP Digital Entertainment Center as follows: <ul style="list-style-type: none"> <li data-bbox="570 614 922 645">a Click Start on the taskbar. <li data-bbox="570 658 941 689">b Click Turn Off Computer. <li data-bbox="570 703 784 734">c Click Restart. <li data-bbox="527 747 1369 809">■ If the HP Digital Entertainment Center shows no response to mouse or keyboard actions, reset the HP Digital Entertainment Center: <ul style="list-style-type: none"> <li data-bbox="570 823 1364 884">a Press and hold the On button for more than four seconds until the HP Digital Entertainment Center turns off. <li data-bbox="570 898 1471 929">b Wait a few seconds, and turn the HP Digital Entertainment Center back on. <li data-bbox="527 942 1455 1068">■ A software program, software driver, or the operating system software may be corrupted, erased, or damaged. You can use Application Recovery or System Recovery to reinstall the software. Refer to the <i>Warranty and Support Guide</i> that came with your HP Digital Entertainment Center. <li data-bbox="527 1081 1451 1335">■ It's possible that a voltage spike, power outage, or brownout has occurred. Symptoms of voltage spikes include a flickering video display, unexpected HP Digital Entertainment Center startups, and the HP Digital Entertainment Center not responding to your commands. A voltage spike can occasionally corrupt or destroy files, so it is a good idea to consistently make backup copies of your data files. Prevent voltage spikes by installing a surge suppressor between the power outlet and the HP Digital Entertainment Center power cord.

Problem	Solution
<p>When I push one of the special or multimedia buttons on the keyboard, nothing happens.</p>	<ul style="list-style-type: none"> ■ Check that the standard keyboard keys and mouse work properly. <p>Or</p> <ul style="list-style-type: none"> ■ Check the button configuration. <p>To configure the button:</p> <ol style="list-style-type: none"> 1 Click Start on the taskbar, and then click Control Panel. 2 Click Printers and Other Hardware, if it is present. 3 Double-click Keyboard. 4 In the Keyboard Properties window that opens, click the Buttons tab. 5 Double-click the button you want to change. The button configuration window opens. 6 Choose the button capability from the drop-down list. Enter the Display label and the Address information. (For a Web site, enter the complete Web site URL in the Address box.) 7 Click OK and then on the Buttons tab, click Apply. 8 Repeat steps 5 through 7 for each button you want to configure. 9 Click OK when you are finished configuring the keyboard.
<p>My keyboard or the trackball doesn't work even though the HP Digital Entertainment Center and TV or monitor seem to work.</p>	<ul style="list-style-type: none"> ■ Make sure the keyboard syncs with the HP Digital Entertainment Center. See "Syncing the Keyboard" on page 123. ■ Try restarting the HP Digital Entertainment Center as follows: <ol style="list-style-type: none"> a Click Start on the taskbar. b Click Turn Off Computer. c Click Restart.

Problem	Solution
<p>The TV or monitor doesn't work, even though the HP Digital Entertainment Center appears to.</p>	<ul style="list-style-type: none"> ■ Make sure the TV or monitor is turned on — it has its own power button. ■ Make sure the proper TV or monitor input is selected. ■ Check the cable connection between the monitor and the HP Digital Entertainment Center. The cable connectors must be pushed in all the way prior to powering on the HP Digital Entertainment Center. ■ Ensure that the cables to your monitor and your TV connect to the Video Out connectors on the HP Digital Entertainment Center. ■ Adjust the brightness and contrast controls on the monitor. ■ Make sure the monitor power cord is plugged into a grounded outlet. Check to see whether the outlet works by plugging another item into it. (If the light on the front of the monitor is lit, the monitor is getting power.) ■ Try restarting the HP Digital Entertainment Center as follows: <ul style="list-style-type: none"> a Click Start on the taskbar. b Click Turn Off Computer. c Click Restart.
<p>My software stopped working.</p>	<p>Refer to the <i>Warranty and Support Guide</i> that came with your HP Digital Entertainment Center to reinstall a software program. If your program came on a CD, follow the instructions that came with the software to reinstall it.</p>
<p>I cannot remove a CD or DVD.</p>	<p>You cannot remove a CD or DVD after you have turned off the HP Digital Entertainment Center. Turn on the HP Digital Entertainment Center and press the Eject button to extend the tray.</p>

Problem	Solution
<p>The memory card reader won't read my memory cards.</p>	<ul style="list-style-type: none"> ■ The memory card reader is a device that uses the Safely Remove Hardware task. This appears as a Windows system tray icon next to the time. Do <i>not</i> click Stop in the Safely Remove Hardware window. If you do click Stop, the drive is disconnected. If this happens, restart the HP Digital Entertainment Center. ■ Do not insert or remove memory cards when the in-use light is flashing. To do so may cause data loss, or it may permanently damage the card reader. ■ Format a memory card before you use it. Click Start and then click My Computer. Under Removable Storage, right-click the memory card icon and select Format. Click Start. Click OK on the Format Complete Window, and then click Close to finish. ■ Some cards have a read/write or security switch on the card. Make sure the read/write switch is set to Write Enabled before attempting to write data to it. ■ Make sure the amount of data you are storing has not exceeded the storage limit of the card. ■ Make sure the memory card is one of the supported types: CompactFlash I/II and Micro drive, Memory Stick, Memory Stick Pro, MultiMedia, Secure Digital, SmartMedia, or /xD. ■ Make sure the memory card is fully inserted into the correct slot. ■ Remove the memory card when the light is not flashing, and shine a flashlight into the empty slot. If any of the pins are bent, have the HP Digital Entertainment Center serviced if a pin is touching another pin. ■ Inspect the ends of the memory cards for dirt or material closing a hole or spoiling a metal contact. Clean the contacts with a lint-free cloth and small amounts of isopropyl alcohol. Replace the memory card if necessary.
<p>My HP Digital Entertainment Center is experiencing video errors.</p>	<ul style="list-style-type: none"> ■ Your file may be corrupt or in an unsupported format. Open the video file in a video editor such as WinDVD Creator, and then resave the file in a supported format. ■ There may be a problem with the codec. For more information, look in Windows Media Player Help, and then search for <i>codec</i>.

Problem	Solution
My DVD won't play.	<p>You can put data files on a DVD to store them or transfer them to another HP Digital Entertainment Center. However, data files on a DVD do not play in a DVD player. Rerecord your files to a file format that can be read by some DVD players.</p> <p>If you are using component output, you may need to change the configuration. See "Component Video Settings" on page 62.</p> <p>Check your DVD country/region.</p>
My DVD won't play a DVD audio disk.	This format is not supported by the DVD player.
I keep running out of disk space.	<p>Burn some big files to DVD and remove them from your hard drive.</p> <p>Upgrade your hard drive. The hard drive is user-replaceable.</p>
I am getting disk errors.	<p>Run disk recovery.</p> <p>Replace your hard drive. The hard drive is user-replaceable.</p>
Codec errors are occurring when I play certain files.	<p>Codec is an abbreviation for compressor-decompressor. A <i>codec</i> is software or hardware used to compress and decompress digital media.</p> <p>If you get a codec error when playing an audio file, open the file in Windows Media Player. Configure Windows Media Player to automatically download codecs. You must be connected to the Internet to download the codec file.</p>
My music files don't appear in the Media Library.	<p>Make sure you use Windows Media Player to add your music files to the Media Library.</p> <p>Check whether the Windows Media Player setting for access rights of other applications is set to <i>No access</i>. It must be set to <i>Read only</i> or <i>Full access</i> for your music files to appear. Refer to Windows Media Player Help for more information</p> <p>For specific audio file formats you may need to refer to HP Tunes library.</p>



If you need more information about using or troubleshooting Media Center, refer to the Media Center online Help or Help and Support in the Start menu.

Getting Help

Help and Support Center

For help, press the Help button on your keyboard, or click **Start** on the taskbar and select **Help and Support**.



The **Help and Support Center** is onscreen Help information about your HP Digital Entertainment Center. Here you can find:

- Links to reinstall drivers.
- Access to technical support options.
- Commonly asked questions about your HP Digital Entertainment Center.

To open the Help and Support Center:

- 1 Press the **Help** button on your keyboard (the ? button).

Or

Start Media Center. Click on the Help (?) icon on the top left of the screen.



Or

Click **Start** on the taskbar and click **Help and Support**.

HP Support

HP Support provides important support information about your HP Digital Entertainment Center.

Here you can find:

- Your product number, model number, and serial number.
- Registration information and link (monitor, keyboard, and mouse recommended).
- Where to find more information about your HP Digital Entertainment Center.
- An HP Digital Entertainment Center hardware test.
- How to contact HP.

To open the HP Support:

- 1 Press Media Center on the remote control.



You can also click **Start** on the taskbar, and select **Media Center**.

- 2 Click **More Programs**, and then **HP Support**.

- 3 Select a program or folder:

- Register now.
- Learn More
- Test Hardware
- Contact HP

Warranty and Support Guide

See the HP Digital Entertainment Center *Warranty and Support Guide*, included with the documentation, for detailed information on:

- HP Web Site Support addresses
 - HP Support telephone numbers
 - HP Customer Care information
 - HP Web Site Online Guide addresses
 - Application and System Recovery Programs
 - The terms of your HP warranty coverage
 - License information
-

HP Web Site Support

The HP Web site provides:

- Supplemental information about the HP Digital Entertainment Center and products
 - HP Support contact
 - Software updates
 - Software patches
 - Online Information and technical support for your HP Digital Entertainment Center
 - Online manuals for your HP Digital Entertainment Center
-

To use the HP Web site:

- 1** Connect to the Internet: Open your Web browser,
Or
Press Connect on your keyboard.
 - 2** Type the Web site address into your Web browser address box. Press Enter.
 - 3** Access the HP Support Web site. Type `http://www.hp.com/support` into the Web browser address box. Press Enter.
 - 4** Select your country/region from the drop-down list. Press the arrow button next to the list.
 - 5** Use the Web site addresses listed in the *Warranty and Support Guide* for information about your HP Digital Entertainment Center and your technical support needs.
-

HP Customer Care

You can get help over the telephone from HP. When you call HP Customer Care, have your model number and serial number available.

See the keyboard or the *Warranty and Support Guide* for the support telephone numbers.

Online Guides

You can find online guides and information for your HP Digital Entertainment Center. To view online manuals for your HP Digital Entertainment Center, go to the Support Web address that is listed in the *Warranty and Support Guide* that came with your HP Digital Entertainment Center, and then search for your product name and number.

Online manuals are associated with specific HP Digital Entertainment Center model numbers. Some models may not have online manuals.

Application and System Recovery Programs

The HP Digital Entertainment Center uses the operating system and installed software programs during normal operation. If your HP Digital Entertainment Center works improperly or stops because of the software, you may be able to repair it by restarting the HP Digital Entertainment Center, using System Restore, or using other methods including the system recovery programs.

Recovery discs (DVDs) are included with the HP Digital Entertainment Center System. You need recovery discs for some repairs that use the system recovery programs.

For instructions on using recovery discs, repairing and recovering your software, and more information, refer to the *Warranty and Support Guide* that came with your HP Digital Entertainment Center.

Problems with software programs may be caused by corruption or damage to an individual program (application or software driver) or to part of the operating system software.

Updates from HP

HP may send updated information or patches to your desktop (not available in all countries/regions). You must be connected to the Internet to receive these updates. If you have turned off the Updates from HP feature, you will not receive these updates.

To turn updates back on:

- 1 Click **Start**, choose **All Programs**, and then **HP Digital Entertainment Center Help & Tools**.
- 2 Click **Updates from HP**, and then **Re-enable Updates from HP**.

Microsoft Web Site

Search the Microsoft Web site (<http://www.support.microsoft.com>) for Knowledge Base articles and updates on Microsoft Windows XP Media Center Edition 2004.

You can also use the Online Spotlight link to get to the Microsoft Windows XP Media Center Web site.

To get the latest news and information about your Microsoft Windows XP Media Center program:

- 1 Press the Media Center button on your remote control. 
- 2 Select **Online Spotlight** from the Media Center Start menu.

Appendix: Replacing the Hard Drive

Important Information About Recorded TV Programs

When you replace the hard disk drive, you lose any files or software that you created, saved, or installed on the HP Digital Entertainment Center. Because of this, you also lose a special code that Microsoft includes in the files of recorded TV programs. Without the code, Media Center cannot play TV programs previously recorded to disk or copied to DVD or to other media.

For more information about safeguarding your recorded TV programs, refer to the *Media Center Edition 2005 Software Guide*.

Procedure

To replace the hard drive:

- 1 Make sure you have the recovery discs (DVDs) included with the HP Digital Entertainment Center System.
- 2 Back up your data to the personal media drive or burn it to DVD.
- 3 Close Media Center and all other programs that may be accessing the hard drive.
- 4 Turn off the HP Digital Entertainment Center.
- 5 Disconnect the power cable from the HP Digital Entertainment Center.
- 6 Disconnect all other cables from the HP Digital Entertainment Center.
- 7 Turn the HP Digital Entertainment Center upside down.
- 8 Remove the hard drive cover from the chassis. After loosening the screw, slide the hard drive in the direction of the screw.

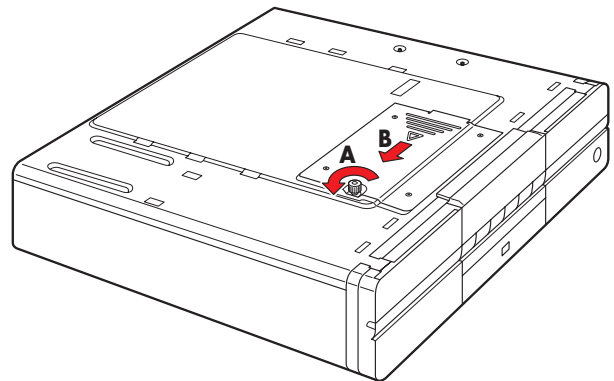

9 Lift up the hard drive from the chassis.

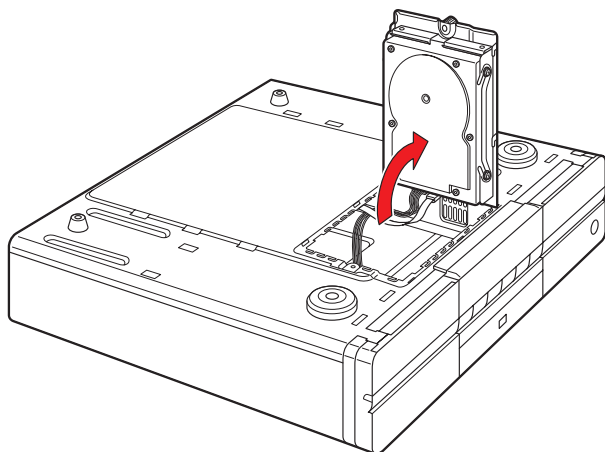

10 Disconnect the hard drive cables.

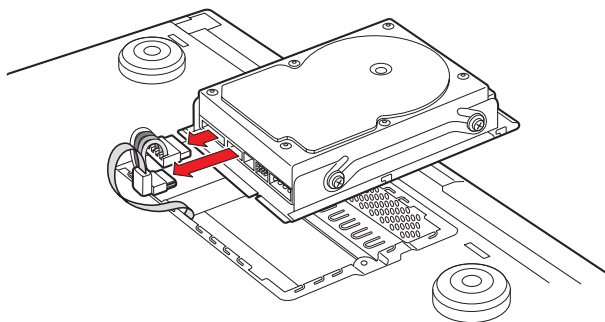

11 Remove the hard drive screws.

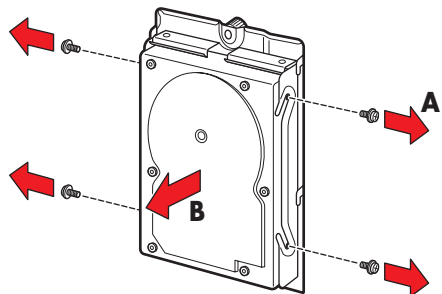

12 Replace the old hard drive with the new hard drive.

13 Replace the hard drive screws. Tighten the screws an additional half-turn only after the screws contact the rubber washer.

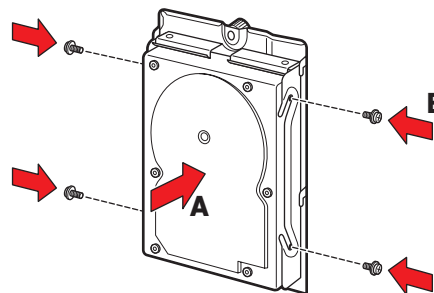

14 Reconnect the hard drive cables.

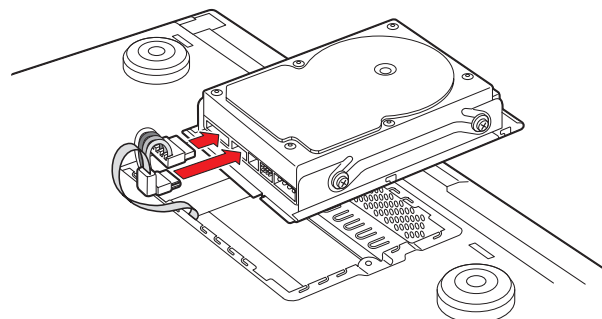

15 Place the hard drive into the chassis. Position the metal tabs.

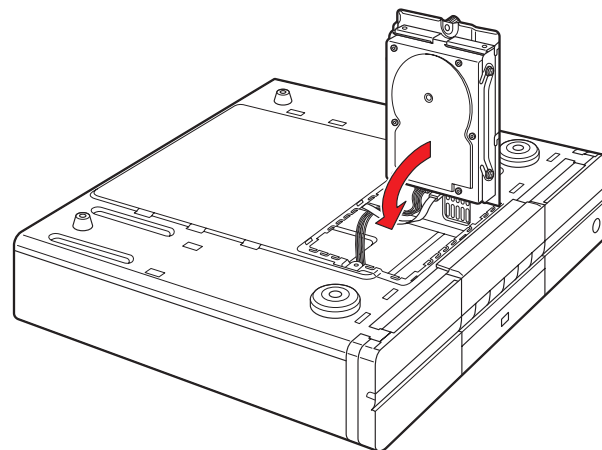

16 Replace the hard drive cover on the chassis.

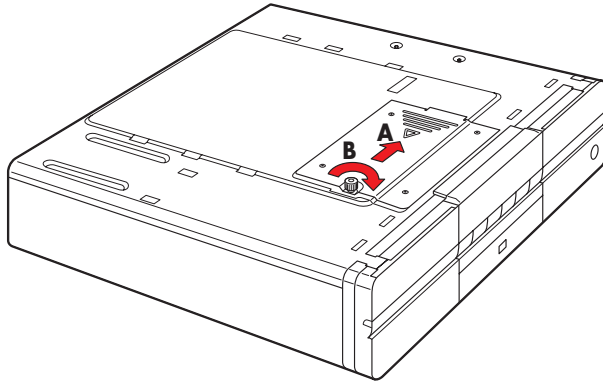

17 Turn the HP Digital Entertainment Center right side up.

18 Reconnect the power cable all other cables to the HP Digital Entertainment Center.

19 Turn on the HP Digital Entertainment Center.

20 Test the HP Digital Entertainment Center for proper operation.

21 Recover your system using the recovery disk.

22 Restore your data.

Index

A

- adjusting
 - desktop display resolution 137
 - front panel brightness 129
 - speaker volume 131
- antenna connection
 - for FM radio 58
 - for rooftop FM 58
 - for wireless network 111
- Application Recovery program 153
- audio files
 - codec errors 150
 - do not appear in Media Library 150

B

- back panel
 - location of connections 6
 - system diagram 26
 - video connector locations 75
- batteries
 - installing in keyboard 122
 - installing in remote control 17
 - replacing in keyboard 13
 - type
 - for keyboard 13
 - for remote control 17
- before you start
 - additional items necessary 34
 - cables you may need 33
 - components supplied 31
 - safety information 19
- brightness, adjusting front panel display 129
- button functions, remote control 14
- buttons
 - configuring keyboard 138

C

- cable modem, connecting 113
- cable receiver
 - dual tuner option 74
 - setting up using Media Center 126

- cables
 - included 32
 - not included 33
- camera
 - connecting digital still 115
 - connecting digital video 103
- clearances, space for HP Digital Entertainment Center 30
- codec errors 150
- configuring Media Center
 - audio settings 132
 - for cable or satellite receiver 126
 - for DVD player 133
 - for multichannel audio 133
 - for optional display 127
 - for your speaker setup 127
 - for your TV tuner and program guide 127
 - front panel display brightness 129
 - selecting recording devices 130
- connecting
 - 2.0 speaker system 43
 - 2.1 speaker system
 - with passive speakers 44
 - with powered speakers 51
 - 4.1 speaker system
 - with passive speakers 45
 - with powered speakers 52
 - 5.1 speaker system
 - with digital input on AV receiver 48
 - with digital speakers 55
 - with passive speakers 46
 - with powered speakers 53
 - 7.1 speaker system
 - with passive speakers 47
 - with powered speakers 54
- antenna, broadcast TV 92
- cable boxes, two 82
- cable with no set-top-box 78
- digital audio to AV receiver 48
- DSL/cable modem 113
- DVD player 97

- FM rooftop antenna 58
- HDTV 67
- microphone 130
- monitor speakers 56
- powered speakers 50
- router, to Internet through 113
- satellite receiver, one 84
- satellite receivers 86
- tape player using Audio In connections 57
- TV displays 60
- TV to watch one channel and record on another 74
- VCR with direct connections 99
- video analog camera 106
- video digital camera 103
- connecting video, overview 98
- connections, system diagram 26
- connector locations
 - for audio output 36
 - for TV source 75
 - for video equipment 96
 - for video output 61
 - on back panel 6
 - on front panel 3
- contacting HP
 - Customer Care by telephone 153
 - using the Web 152

D

- data files on DVDs, troubleshooting 150
- digital audio, 5.1 supported formats 48
- digital speakers, connecting 55
- disconnecting, TV 136
- display resolution, adjusting 137
- documentation
 - how to find HP support information 152
 - how to find online manuals 153
- DSL modem
 - connecting 113
 - order of powerup 19

- dual displays
 - configuring with Media Center 127
 - disabling 136
 - switching between 134
- DVD player
 - configuring audio settings 132
 - configuring using Media Center 133
 - location of connectors 97
 - troubleshooting 150
 - use with data files 150

E

- error messages
 - codec error when playing certain files 150
 - from hard drive 150

F

- FAQs, how to find 151
- feature overview 2
- FireWire input-output, location on front panel 4
- FM antenna, connecting 58
- front panel, adjusting display brightness 129

H

- hard drive
 - connecting HP Personal Media Drive 117
 - location on front panel 3
 - replacing 155
 - running out of disk space 150
 - troubleshooting 150
- hardware test, for HP Digital Entertainment Center 151
- HDTV, using Video Out connectors 60
- headphones, location of output on front panel 4
- help
 - how to find 151
 - Microsoft Web site 154
- how to configure Media Center
 - for cable or satellite receiver 126
 - for optional display 127
 - for your speaker setup 127
 - for your TV tuner and program guide 127

- how to connect
 - 2.0 speaker system 43
 - 2.1 speaker system
 - with passive speakers 44
 - with powered speakers 51
 - 4.1 speaker system
 - with passive speakers 45
 - with powered speakers 52
 - 5.1 speaker system
 - with digital input on AV receiver 48
 - with digital speakers 55
 - with passive speakers 46
 - with powered speakers 53
 - 7.1 speaker system
 - with passive speakers 47
 - with powered speakers 54
- broadcast antenna 92
- cable boxes, two 82
- cable with no set-top-box 78
- camera, digital still 115
- camera, digital video 103
- digital speakers 55
- DSL/Cable modem 113
- DVD player 97
- FM radio 58
- FM rooftop antenna 58
- HP personal media drive 118
- monitor speakers 56
- powered speakers 50
- remote IR 90
- router, to a LAN through 114
- satellite receiver, one 84
- satellite receivers, two 86
- USB devices 116
- VCR 99
- wireless network antenna 111
- how to find
 - FAQs 151
 - help 151
 - HP Digital Entertainment Center hardware test 151
 - utility programs 139
- how to obtain updates 154
- how to register for updates 129
- how to replace
 - batteries in keyboard 13
 - batteries in remote control 17
 - hard drive 155
- how to switch
 - inputs using your monitor 71
- how to switch between audio and video
 - using your monitor 70
 - using your receiver 68
 - using your TV 66
- how to switch between dual displays 134
- how to synchronize, the keyboard 123
- how to transfer PC data to HP Digital Entertainment Center 138
- HP Application Recovery 153
- HP Customer Care
 - contacting by telephone 153
- HP Digital Entertainment Center
 - box contents 31
 - recovery after a power outage 146
 - reset procedure 146
 - support for 151
- HP Help and Support Center 151
- HP Personal Media Drive
 - automatic on and off feature 117
 - disconnecting 119
 - installing 118
 - running the media drive utility 118
- HP Web site 152

- I**
- installing
 - additional software and devices 139
 - batteries in keyboard 17
 - batteries in remote control 122
- Internet
 - connecting DSL/cable modem 113
 - connecting through a router 114
 - typical configurations 110
- K**
- keyboard
 - configuring buttons 138
 - function keys 10
 - replacing batteries 13
 - synchronizing 123, 147
 - troubleshooting 123, 147
- M**
- Media Center
 - adjusting desktop display resolution 137
 - configuring audio settings 132
 - dual displays option
 - disabling 136
 - enabling 135
 - Microsoft Web site 154
 - obtaining update information 154
 - registering for updates 129
 - testing system connections 128
 - utility programs 139
 - viewing on a second display 135
- Media Library
 - music files not displaying 150
 - troubleshooting 150
- memory card reader
 - location of slots on front panel 5
 - troubleshooting 149
- microphone
 - connecting 130
 - location of inputs on front panel 4
- Microsoft Web site
 - information about Media Center 154
- monitor
 - connecting 71
 - troubleshooting 148
- N**
- network
 - connections supported 107
- network connectors
 - location on back panel 109
 - on back panel 108
- O**
- Online Spotlight, accessing using Media Center 154
- overview
 - connecting audio devices 36
 - connecting video equipment 98
 - features 2
 - TV signal source 74
 - video input connections 74
 - video out connections 60
- P**
- power outage, recovery from 146
- printer
 - connecting 116
 - troubleshooting 145
- R**
- recorded TV programs, protecting 155
- recording devices, configuring with Media Center 130
- recovery disk
 - about 153
 - as used after replacing hard drive 157
 - supplied 31

- recovery programs, using 140
- registering for updates 129
- remote control
 - button functions 14
 - installing batteries 17
 - maximum range 16
 - troubleshooting 144
 - using with your TV 64
- remote IR transmitter cable connection
 - connecting 90
 - importance of placement 88
 - location 89
 - relation to cable box and satellite receiver 88
 - troubleshooting 144
- removing
 - CD/DVD 148
 - personal media drive 117
- replacing
 - batteries in keyboard 13
 - batteries in remote control 17
 - hard drive 155
- requirements, network connections 107
- reset procedure, HP Digital Entertainment Center 146
- resolution, adjusting desktop display 137
- router, connecting to 114
- S**
- safety information 19
- satellite receiver
 - connecting one unit 84
 - connecting two units 86
 - dual tuner option 74
 - setting up using Media Center 126
- scanner, connecting 116
- sensor, remote IR transmitter cable connection, connecting 90
- speaker types, supported 37
- speakers
 - 2.0 system setup 43
 - 2.1 system setup
 - with passive speakers 44
 - with powered speakers 51
 - 4.1 system setup
 - with passive speakers 45
 - with powered speakers 52
 - 5.1 system setup
 - with digital speakers 55
 - with passive speakers 46
 - with powered speakers 53
 - 7.1 system setup
 - with passive speakers 47
 - with powered speakers 54
 - configuring audio settings 132
 - configuring using Media Center 127
 - connecting monitor speakers 56
 - testing using Media Center 133
 - troubleshooting surround sound 142
 - troubleshooting volume problems 142
- subwoofer
 - for digital speaker setup 55
 - for monitor speaker installation 56
- support for HP Digital Entertainment Center 151
- supported
 - 5.1 digital audio formats 48
 - network connection types 107
 - speaker types 37
- surround sound, troubleshooting 142
- S-video
 - connection requirements 60
 - jack and cable compatibility 97
 - location on front panel 4
- switching audio video
 - using your monitor 70
 - using your receiver 68
 - using your TV 66
- switching, between dual displays 134
- synchronizing the keyboard 123, 147
- system components, inventory of 31

- T**
- tape player, connecting 57
 - testing
 - audio settings using Media Center 133
 - system connections using Media Center 128
 - transferring data from PC to HP Digital Entertainment Center 138
 - troubleshooting
 - audio problems 142
 - DVD player 150
 - hard drive 150
 - keyboard 147
 - memory card reader 149
 - monitor 148
 - music files 150
 - power up of HP Digital Entertainment Center 145
 - printer 145
 - remote control 144
 - remote sensor 144
 - removing CD/DVD 148
 - speaker volume 142
 - special keyboard buttons 147
 - surround sound 142
 - system connections using Media Center 128
 - TV problems 143, 148
 - unexpected startups 146
 - video errors 149
 - turning on
 - location of power button 3
 - troubleshooting 145
 - TV
 - adjusting desktop display resolution 137
 - configuring with Media Center 127
 - disconnecting 136
 - troubleshooting 143, 148
 - viewing PC image on a second TV 135
- U**
- USB device, connecting 116
 - utility programs, location 139
- V**
- VCR, connecting 99
 - video analog camera, connecting 106
 - video digital camera
 - connecting 103
 - FireWire connection 4
 - troubleshooting connections 143
 - video display flickering 146
 - video system
 - errors 149
 - location of output connectors 60
 - virus protection, need for 129
 - volume icon, locating on task bar 131
 - volume of speaker, adjusting 131
- W**
- warnings
 - against removing media while LED is blinking 5
 - disconnecting disk drive while it is operating 119
 - loss of recorded programs 155
 - moving personal media drive while it is operating 117
 - order of power connection 19
 - use of correct AC power source 19
 - Warranty and Support Guide, about 152
 - Web address
 - for Media Center information 154
 - for registering your HP Digital Entertainment Center 129
 - Web site support, HP Customer Support 152
 - wireless keyboard, location of LED 4
 - wireless network, connecting antenna 111
- Y**
- Y adapter cables, required for speakers 50

Free Manuals Download Website

<http://myh66.com>

<http://usermanuals.us>

<http://www.somanuals.com>

<http://www.4manuals.cc>

<http://www.manual-lib.com>

<http://www.404manual.com>

<http://www.luxmanual.com>

<http://aubethermostatmanual.com>

Golf course search by state

<http://golfingnear.com>

Email search by domain

<http://emailbydomain.com>

Auto manuals search

<http://auto.somanuals.com>

TV manuals search

<http://tv.somanuals.com>