

Instruction manual

GB

MICROWAVE OVEN

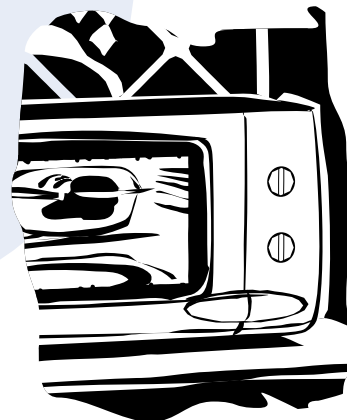

QN 4021
QN 4039

 Husqvarna

Contents

Before using your microwave oven		Quick Start	16
Safety Instructions	5	Child Lock	16
Utensil & food safety	6	Minute timer with alarm	16
Suitability of cookware	7		
		Charts	
Installation	8	QN 4021	
Built-in model	8	Defrosting	17
Electrical connections	8	Cooking vegetables	19
		Cooking fish	19
Description of the microwave oven and accessories		QN 4039	
The microwave oven	9	Defrosting	20
Accessories	9	Cooking vegetables	22
Control panel	10	Cooking fish	22
		Care and cleaning	
Before using your microwave oven for the first time		Cleaning the accessories (turntable, support)	23
Cleaning	11	Cleaning the interior	23
Setting the clock	11	Cleaning the exterior	23
		If the microwave does not function	24
How to operate your microwave oven		Service and spare parts	25
Microwave cooking	12	Technical data	25
Microwave setting guide	12		
Automatic programmes	13	Guarantee conditions	
Auto Defrost	13	Standard guarantee conditions	26
Automatic cooking programmes	14	European Guarantee	26
Microwave hints	15		

Congratulations on the purchase of your new microwave oven

Thank you for having chosen an Husqvarna product. We are convinced that you will find your new microwave oven very useful and that it will be of great help to you. As with all new kitchen appliances, it will take some time to learn all the new functions and features, but with time, this oven will become indispensable to you. In order that you can get the best from your new Husqvarna microwave oven, the following instructions have been prepared. Please make sure you read them carefully. It is important that this instruction book is retained with the appliance for future reference. Should the appliance be sold or transferred to another owner, or if you move house and leave the appliance, always ensure that the book is supplied with the appliance.

Microwave cooking provides true innovation for the culinary arts. Combining rapidity and ease of use, it enhances flavours and aromas all the while keeping the appearance and nutritive qualities intact.

Your microwave oven will complement your other kitchen appliances. It cooks, reheats and defrosts quick as a wink, affording you considerable time and energy savings.

The microwaves used for cooking are electromagnetic waves. They exist in our environment as do radioelectric waves, light, and infrared rays. They are reflected by metals. They pass through all other materials. They are absorbed by water, sugar and fat molecules.

When food is exposed to microwaves there follows a vibration of the molecules, which in turn produces heat.

The depth of penetration of the waves into food is about 2.5 cm. If the food is thicker the centre is cooked by normal conduction of heat.

It is worth noting that the microwaves produce a simple heat reaction inside food and are not at all harmful to your health.

Due to the nature of microwave cooking, foods rich in water, sugar or fat require less cooktime and yield the best results.

Safety instructions

General

- Your appliance is designed exclusively for the domestic purposes of defrosting, heating or cooking foods. The manufacturer bears no responsibility in the case of improper usage.
 - The appliance should only be operated with the turntable and turntable support inserted.
 - Only suitable microwave ovenware should be used.
 - Do not leave the appliance unattended when warming or cooking food in disposable containers made of plastic, paper, or other flammable materials, due to fire hazard.
 - If smoke is observed, turn the oven off, disconnect the power supply and keep the oven door closed to extinguish any flames. Contact your local HUSQVARNA Service Force Centre. Never use the microwave oven if it is no longer functioning properly.
 - This appliance complies with all relevant safety instructions. In order to maintain the safety of the appliance, repairs should only be carried out by a HUSQVARNA Service Force Centre. **WARNING:** it is dangerous for anyone other than qualified personnel to make any repairs requiring removal of the cover providing protection from exposure to microwave energy. In the case of any defect or breakdown, please therefore contact your local HUSQVARNA approved retailer or the HUSQVARNA Service Force Centre.
- **WARNING:** Should the door seals and / or door seal surfaces be damaged, the appliance should not be operated until it has been repaired by the HUSQVARNA Service Force Centre.
 - Damaged appliance parts can only be replaced by exactly the same make of parts. Special tools are required for this operation.
 - Never tamper with the lock mechanism of your microwave oven; you could cause damage requiring repair by an authorised technician.
 - **WARNING:** This appliance is designed to be operated by adults. Do not allow children to use the microwave oven without supervision unless they have been thoroughly instructed in the proper use and the dangers of improper operation.

For trouble free and safe operation

- Never jam anything between the door and the door frame.
- Always keep the door seals and their surfaces clean.
- Do not keep any flammable items in the microwave. They could ignite when the unit is switched on.
- Switch the appliance on only when the food has been placed inside the cooking space, as it could overload if there is no food present.

Utensil & food safety

- During delayed boiling, the boiling temperature is attained without the typical steam bubbles rising. When the container is shaken, even gently, the liquid may then suddenly vigorously boil over or spurt - with the **risk of scalding the user**. To prevent liquids from boiling over and possible burns, whenever heating liquid, please place a teaspoon in the container and wait 20 seconds before removing the containers from the appliance or adding anything to the liquid, to avoid sudden spurting of the liquid.
 - **WARNING** : Be sure to remove the cap or lid before cooking foods or heating liquids in a sealed bottle or container, which could otherwise explode.
 - Make sure that a minimum temperature of 70°C is attained for the cooking / heating of food. Never use a mercury or liquid thermometer for measuring the temperature of the food.
 - Baby food in jars or bottles should always be heated without a lid or top, and well stirred or shaken after heating, to ensure uniform distribution of the heat. **Always check the temperature before feeding to your child in order to avoid scalding.**
 - The hot food in a microwave oven will heat up the ovenware. For this reason always **use oven gloves** for handling hot dishes.
 - Never cook your food for too long or at too high a power setting. Some areas of the food can dry out or even ignite.
- To protect the appliance against corrosion from moisture (condensation) in the cavity or on the door, wipe these areas dry after each use.
 - Do not use porcelain or ceramic crockery, or porous earthenware (e.g. on the handles or unglazed bases) in your microwave as these types of dishes can absorb moisture from the food as it is cooking. This can cause vapour pressure to build up which could shatter the dish.
 - Food with «skin» or «peel», such as potatoes, tomatoes, sausages, and the like, should be pierced with a fork so that any steam present can escape and the food will not burst.
- Do not use your microwave oven for the following :**
- The heating or cooking of boiled, coddled eggs or fried eggs by microwave is prohibited. They can burst and cause serious burns or irreparable damage to your oven.
 - to heat large quantities of cooking oil (fondue or deep frying) and drinks containing a high percentage of alcohol - **there is danger of spontaneous combustion!**
 - to heat unopened cans, bottles, etc.
 - to dry animals, textiles or paper.

Suitability of cookware

Place the cookware in the microwave along with a glass half full of water. Heat on maximum power level for one minute. If the cookware feels hot, you should not

use it. If it is just slightly warm, you can use it for reheating but not for cooking. If the dish is room temperature, it is suitable for microwave cooking.

Ovenware material	Suitability
Ovenproof glass and ceramic dishes (without any metal parts, e.g. Pyrex, oven-to-tableware, pie dish)	X
Non ovenproof glass and porcelain (e.g. table crockery ¹⁾)	X
Glass ceramic and vitroceraamic made of fire/frostproof material (e.g. Arcoflam)	X
Ovenproof earthenware ²⁾	X
Plastic, heat-resistant up to 200°C	X
Paper, cardboard	X
Cling film	X
Metal roasting pans, e.g. enamel or cast-iron dishes	-
Black-lacquered or silicone coated baking tins	-

X suitable - non suitable

¹⁾ excluding silver, gold, platinum or metal decoration

²⁾ does not include glaze containing metal

Installation

- When you unpack the oven, check that the product is free from damage. Damage or any missing parts must be reported immediately to the retailer. The oven, parts of the oven or the accessories may be wrapped by a protection foil. If so, you must remove this foil before using the oven. Do not leave packing material so that small children can play with it. This can be hazardous.
- Do not use your appliance immediately (wait approx. 1-2 hours) after transfer from a cold place to a warm place as condensation may cause a malfunction.
- This oven can be used as a free standing oven or built-in using the kit available with the oven. To install the oven in a kitchen cabinet follow the instructions supplied with the building-in kit. The oven should be installed on a flat, level surface at least 85 cm above floor level. The surface must be strong enough to safely bear the weight of the oven, and the contents. To avoid the possibility of causing vibration or noise, the oven must be in a stable position.
- Be sure to install the oven away from heat and water sources.
- Do not block air vents on the top and the sides of the cabinet nor place any articles on the top of the oven. A gap all around the oven is necessary : 20 cm above the oven and any objects, 5 cm on the sides and 10 cm behind the oven. If air vents are blocked during operation, the oven may overheat, and this may lead to malfunctioning.

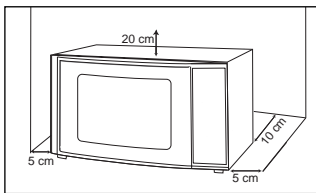

- This oven does conform to EEC requirements* of radio interference suppression, but some interference may occur if it is placed too close to a radio or TV, so keep them as far apart as possible.

Built-in model

- To install the appliance in a kitchen cabinet, use the appropriate mounting frame, kit number EBR/BF 517 or 617 for model QN 4021 or kit number EBR/BF 624 for model QN 4039. When building into a high cabinet, you may use the liftdoor. Note the relevant information for installation and connection given in the operating instructions. **Attention !** Never operate the microwave oven with the lift door closed. Such operation would damage your appliance and invalidate the guarantee.

Electical connections

- The oven is delivered with the power cord and a plug for 230-240 V, 50Hz, earthed socket outlet.
 - Earth protection minimizes the risks should a short-circuit occur. Check to ensure the voltage of the oven matches the supply. N.B. If the oven is connected to the socket via an extension cord, make sure the cord is earthed.
- This appliance must not be used on a non-earth protected power supply. Contact an electrician if you are uncertain regarding electrical connection of the oven or provision of earth protection of the supply.
- Microwave power output : QN 4021 - 750W / QN 4039 - 900W
 - This appliance complies with E.E.C. directive No. 87/308 of 2.6.87 relative to radio interference suppression.

Description of the microwave oven

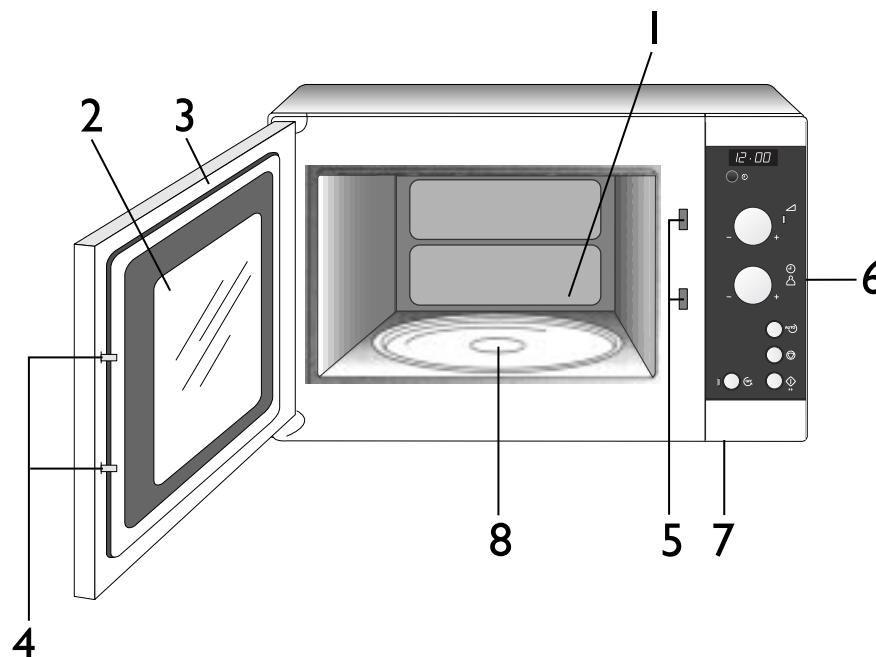

- 1 Cooking compartment
- 2 Viewing window
- 3 Oven door
- 4 Door catch

- 5 Safety interlock system
- 6 Control panel
- 7 Door open button
- 8 Drive shaft for turntable

Accessories

Turntable and turntable support

The turntable and turntable support should be installed as shown in the diagram. Take care to ensure the turntable support is properly in place.

The turntable may turn clockwise or counterclockwise during operation. Do not rotate the turntable manually, as you could damage the drive system.

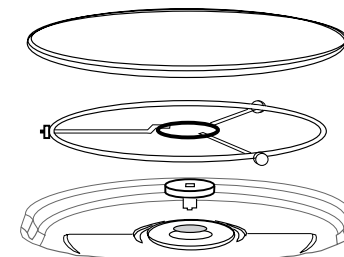

Description of the microwave oven

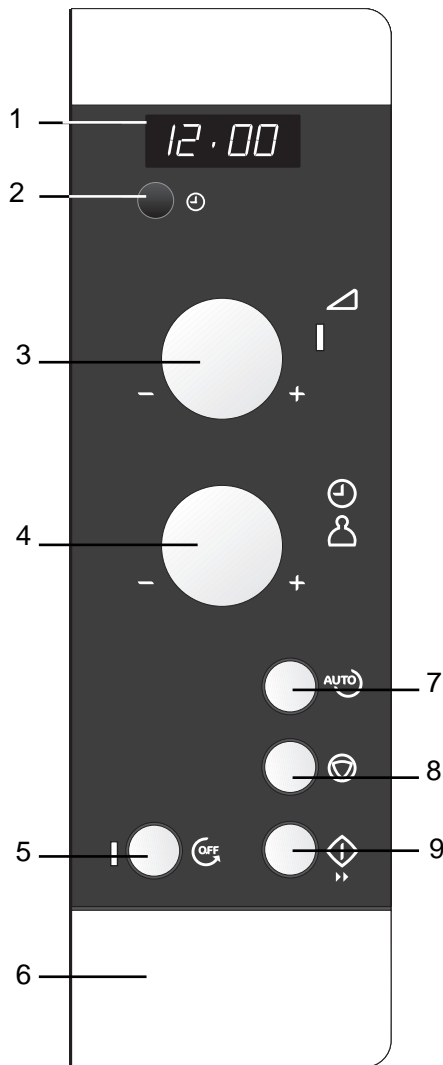

Control panel

- 1 **Display window** – showing time of day, function, cooking time and weight.
- 2 **Multifunction button** to set the time of day and display the selected microwave power level, etc.
- 3 **Power knob** with signal light to select microwave power level.
4. **Timer/weight knob** – to select cooking time or weight when using automatic programmes.
- 5 **Button for switching the turntable off**, with signal light.
- 6 **Button for opening door**
- 7 **Auto button** for automatic cook programmes or Auto Defrost programmes by weight.
- 8 **Clear/Stop** – to cancel or interrupt a cooking programme.
- 9 **Start button** – to start the selected programme and to switch on QUICK start.

Before using your microwave oven for the first time

Cleaning

Wipe over the front of the oven with a damp cloth. Do not use abrasive cleaning agents (these can damage the surface). For stainless steel fronts, use a suitable stainless steel cleaning agent that leaves a protective film against fingerprints. Before you first use the appliance, remove all the accessories (including the turntable and turntable support) from the cooking compartment. Wash the accessories in warm water and washing up liquid. Wipe the cooking space with a soft, damp cloth.

Setting the clock

Plug the appliance into the mains.

The display starts to flash "00:00".



The dots between the digits will flash rapidly.

Example: **12:15**

Press the multifunction button. The dots between the digits flash faster.

While keeping the multifunction button pressed, set the time of day with the Timer knob.



Release the button as soon as the time is displayed.

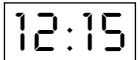

The dots between the digits flash slowly.

The appliance is now ready for use.



The Timer knob can be turned clockwise (to increase) or counterclockwise (to decrease).

The time of day can be changed at any time by pressing the multifunction button and simultaneously turning the Timer knob.

Microwave cooking

Example: 1 min 15 s at 700 W

1. Set the required microwave power by turning the Power knob. The signal light comes on. The time of day disappears from the display and the selected microwave power appears. **turn to the left = lower power**
turn to the right = higher power

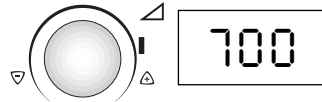

2. Set the required cooking timer by turning the Timer knob. The chosen time appears in the display.



3. Press the Start-button. The selected time starts to count down.

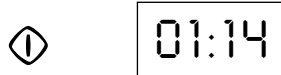

Cooking time can be set as follows: from 0 to 2 min in 5 second steps
from 2 to 5 min in 10 second steps
from 5 to 10 min in 20 second steps
from 10 to 20 min in 30 second steps
starting from 20 min in 1-min. steps

Maximum programme length is 60 minutes.

Metal items must be kept at least 2 cm from the oven sides and the oven door.

Microwave setting guide

MAXI	- heating liquids
700W	- to start roasting, stewing, etc. - cooking vegetables - cooking dishes
600W	- defrosting and heating of deep frozen ready made meals
500W	- heating refrigerated ready made meals - finish cooking casseroles - cooking egg based dishes
450W	- finish cooking casseroles
350W	- cooking of delicate dishes
250W	- heating baby food in glass jar - soaking rice - heating delicate dishes - melting of gelatin
150W	- defrosting meat, fish and bread
80W	- defrosting cheese, cream and butter - defrosting cakes with cream or butter icing - to let dough rise - warming cold dishes, drinks, softening butter

Automatic programmes

Programmes for defrosting and cooking are available. After having selected the programme, merely enter the weight of the dish, the rest of the programming is done

automatically. The following gives you an overview of what food can be defrosted, cooked or combination cooked with which programme.

Auto defrost



Programme	Food category	Example	Weight from - up to
d1	Poultry ¹⁾ Fish	Poultry (whole or parts) (whole or fillets)	100 - 2000 g 100 - 2000 g
d2	Meat	Porc roast, goulash	100 - 1000 g
d3	Delicate cakes, pastries	Cream pie	100 - 1000 g

¹⁾ Cover legs and wings with aluminium foil before defrosting.



Unpack the frozen dish, place inside a larger one to hold the liquid from defrosting. Follow our recommended standing time (general rule: standing time = defrosting time). A triple beep will sound halfway through defrost time. Turn or mix dish and, if possible, break up into pieces.

Example: To defrost a 1 kg chicken

1. Press the button for Automatic defrost until **d1** appears in the display.
2. Use the Timer/weight knob to set the weight.
3. Press the Start button. The display shows the defrost time.
4. If you want to modify the settings, press the Clear button and start again.

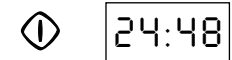
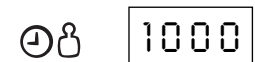

Automatic cooking programmes 

Program	Food categories	Examples	Weight
C1	Fresh vegetables I	Brussels sprouts, cabagge, carrots, celeriac	100–1000 g
C2	Fresh vegetables II	Corgettes, leeks, potatoes, spinach, fennel, cauliflower, broccoli	100–1000 g
C3	Frozen vegetables	Carrots, cauliflower, corgettes, leeks, Brussels sprouts, spinach, broccoli	100–1000 g



Cook covered, in a heat-resistant glass dish, whenever possible. A triple beep rings halfway through cook time. If cooking over 500 g of vegetables, stir once or twice.

Please add water in the following amounts:

– for fresh vegetables (I + II):
 100 – 500 g: 3 – 6 tbsp
 500 – 1000 g: 9 – 12 tbsp

– for frozen vegetables:
 100 – 500 g: 3 – 9 tbsp
 500 – 1000 g: 9 – 15 tbsp

Microwave hints

- Always keep the oven clean – avoid spill-overs and do not forget to clean under the glass tray and the inside of the door.
- Preferably use round or oval casseroles with a lid when cooking in your microwave oven.
- Do not use metal or metal decorated casserole dishes. Certain plastic materials can melt and be warped by hot food.
- Cover the food when cooking. Use a glass lid, a plate or grease-proof paper.
- Pastry, bread and the like can be defrosted directly in a bread basket or on a paper towel.
- If frozen food is heated in its packaging, the packaging should be opened. Packaging containing metal or metal decoration must not be used unless specifically recommended for use in the microwave. Remove metal clips and wire ties.
- Smaller pieces of aluminium foil can be used to cover parts that easily overcook such as chicken legs.
- Food with peel or skin should be pierced with a fork – e.g. potatoes and sausages. Do not boil eggs in the microwave oven as they can explode.
- Put large, thick pieces close to the edge of the casserole and try to cut the food into even-sized pieces. Always place the food in the centre of the oven.
- The food will be more evenly cooked if you stir or turn it regularly.
- Always set a shorter cooking time than indicated in your recipe to avoid overcooking. The larger the amount of food the longer it takes.
- Use little or no water for vegetables.
- Use less salt and spices than with traditional cooking methods.
- Season at the end of the programme.
- Allow a few minutes 'standing time' after the oven has switched off to ensure complete and even cooking results.
- Always ensure food is piping hot throughout before serving.
- Use gloves when taking dishes and food from the oven.

Quickstart

How to set

The Quick Start function provides full microwave power from 30 seconds up to 2 minutes and 30 seconds, in 30 second intervals.

Example: heating a cup of water (1 min 30 s)

1. Press the Start/Quick button three times. The time appears in the display and the programme begins.
2. You may increase the time by 30 second intervals while the programme is running up to a limit of 2 minutes and 30 seconds by pressing the Start/Quick button.

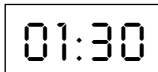

Childlock

This oven is equipped with a Child Lock Safety feature to prevent accidental operation by children.

How to set:

First press the Clear button **5 times**, then press the Start button. The display shows "LOC". The safety lock prevents the oven from operating. There will be no effect if you turn either knob or any button.



How to cancel:

Press the Clear button **5 times**, then press the Start button. A beep will sound then. The time of the day will appear in the display again and the appliance will function as normal.



Minute timer with alarm

The minute timer with alarm can also be used as a general purpose reminder. The timer works without selecting a cooking function.

How to set:

1. Select the microwave power "0" using the Power knob (all the way to the left).
2. Set the required time with the Timer knob. The time of day disappears from the display and the selected length of time appears.
3. Press the Start button. The pre-set time will start to count down. An audible signal will sound when the timer has finished counting down.



Charts

Defrosting

Model QN 4021

Description	Weight (g)	Power (Watt)	Duration (min)	Standing time (min)	Remarks/Hints
Meat					
Whole meat	500	150	10–15	10–15	Turn once. Cover fatty parts with aluminium foil midway through.
Steak	200	150	4–6	5–10	Turn once.
Mixed chopped meat	500	150	9–14	10–15	Remove defrosted chopped meat midway through programme.
Poultry					
Chicken	1000	150	25–35	15–30	Turn once. Cover legs and wings with aluminium foil midway through programme.
Duck	1500–2000	150	35–45 45–55	30–40 50–60	As for chicken.
Fish					
Whole fish	500	150	10–15	10–15	Turn once. Cover fins with aluminium foil.
Shrimps/Crab	250	150	6–8	10–15	Stir thoroughly after half the defrosting time.
Dairy produce					
Cottage cheese	500	150	15–20	15–20	Remove any aluminium foil wrapping. Divide and stir frozen pieces from time to time.
Butter	250	150	2–5	15–20	Remove any aluminium foil wrapping.
Cheese	250	150	3–5	20-30	Turn once.
Cream	200 ml	150	6–8	15–20	Remove any aluminium foil wrapping. Stir frozen pieces from time to time.
Fruit					
Strawberries	500	150	12-14	5–10	Defrost in a covered container, turn once.
Cherries	250	150	6–8	5–10	As for strawberries.
Black currants	250	150	7–9	5–10	As for strawberries.
Red currants	250	150	7–9	5–10	As for strawberries.

Description	Weight (g)	Power (Watt)	Duration (min)	Standing time (min)	Remarks/Hints
Bread					
Rolls (50 g)	4 units	150	2-4	3-5	Set on a paper towel, turn once.
Whole meal, mixed, rye Loaf	1 slice (60-80 g) 500	150	40s-50s 6-8	2-3 15-20	Defrost in a covered container. Cover cutting surface.
Pastry					
Dry cakes e.g. cakes with short crust pastry	300	80	4-6	8-10	Set on a paper towel, cover.
Fruit flans baked on a baking sheet	400-450	80	8-12	5-10	As for dry cakes.
1 slice cheese cake	400	80	8-12	5-10	As for dry cakes.
1 slice covered apple tart	400	80	8-12	5-10	As for dry cakes.
Cream and butter-cream layer cakes	300-400	80	5-8	10-20	Begin defrosting of cakes in the appliance, then remove.
Melting food					
Chocolate/toppings	100	700	1-2		Break up into pieces, stir from time to time.
Butter	50	900	30s-1min		To warm set time for 30 s longer.
Heating of refrigerated food and drink					
1 jar baby food	125-250	450	55s-1min20	2-3	Heat jar without lid. Stir after warming. Check temperature.
1 ready meal on a plate	350-400	750	2-4	2-3	Heat in a covered container. Place gravy alongside in a cup.
1 portion of meat	150	750	1min15-1min30	2-3	All meat, except breaded meat, should be heated in a covered container.
1 portion vegetables, potatoes or rice	200	750	2-2min30	2-3	Heat in covered container, stir once.
1 cup soup	200 ml	750	1min20-1min40	2-3	Heat clear soup uncovered, cover thick soups. Stir.
Drinks					
Milk or baby food	200 ml	750	45s-50s	2-3	Remove any lids. Stir. Check temperature !
Boil 1 cup water	180 ml	750	1min45-2	2-3	Stir instant coffee or tea when the water has stopped boiling.

1 cup milk	200 ml	750	1min45-2	2-3	Heat milk till it is just hot enough to drink. Stir.
1 cup coffee (reheat)	200 ml	750	45s-50s	2-3	Stir. Check temperature !

Defrosting and heating of frozen convenience foods

1 portion meat with gravy	150	750	2-3	2-3	Heat in a covered container. Stir now and again.
1 portion meat with vegetables, garnish	350-450	750	7-9	2-3	As for meat with gravy.

Cooking vegetables

Cook all vegetables in a covered container.

Description	Weight (g)	Liquid added	Power (Watt)	Duration (min)	Standing time (min)	Remarks/Hints
Meat						
Cauliflower	500	1/8 l	750	9-11	2-3	Dot with butter.
Frozen broccoli	300	1/8 l	750	6-8	2-3	Stalks facing outwards.
Mushrooms	250	none	750	6-8	2-3	Cut into slices.
Frozen peas and carrots	300	1/2 cup	750	7-9	2-3	
Carrots	250	2-3 tsp.	750	8-10	2-3	Cut into cubes or slices.
Potatoes	250	2-3 tsp.	750	5-7	2-3	Peel and quarter.
Red/green peppers	250	none	750	5-7	2-3	Cut into cubes or slices.
Leeks	250	1/2 cup	750	5-7	2-3	Cut into rings or pieces.
Frozen Brussels sprouts	300	1/2 cup	750	6-8	2-3	

Cooking fish

Description	Weight (g)	Power (Watt)	Duration (min)	Standing time (min)	Remarks/Hints
Fish fillets	500	600	10-12	3	Cook covered, turn half way through cooktime.
Whole fish	800	1) 750	3-5	3	Cook during cooking.
	500	2) 450	10-12	3	Cook flat parts with aluminium foil.



The times stated here are for guidance only.

Charts

Defrosting

Model QN 4039

Description	Weight (g)	Power (Watt)	Duration (min)	Standing time (min)	Remarks/Hints
Meat					
Whole meat	500	150	10–15	10–15	Turn once. Cover fatty parts with aluminium foil midway through.
Steak	200	150	4–6	5–10	Turn once.
Mixed chopped meat	500	150	9–14	5–10	Remove defrosted chopped meat midway through programme.
Poultry					
Chicken	1000	150	20–30	15–30	Turn once. Cover legs and wings with aluminium foil midway through programme.
Duck	1500–2000	150	35–45	40–60	As for chicken.
Fish					
Whole fish	500	150	10–15	15–20	Turn once. Cover fins with aluminium foil.
Shrimps/Crab	250	150	6–8	15–20	Stir thoroughly after half the defrosting time.
Dairy produce					
Cottage cheese	500	150	15–20	15–20	Remove any aluminium foil wrapping. Divide and stir frozen pieces from time to time.
Butter	250	150	2–3	15–20	Remove any aluminium foil wrapping.
Cheese	250	150	2–4	20–30	Turn once.
Cream	200 ml	150	6–8	15–20	Remove any aluminium foil wrapping. Stir frozen pieces from time to time.
Fruit					
Strawberries	500	150	7–9	10–15	Defrost in a covered container, turn once.
Cherries	250	150	5–7	5–10	As for strawberries.
Black currants	250	150	5–7	10–15	As for strawberries.
Red currants	250	150	4–6	5–10	As for strawberries.

Description	Weight (g)	Power (Watt)	Duration (min)	Standing time (min)	Remarks/Hints
Bread					
Rolls (50 g)	4 units	150	1–3	3–5	Set on a paper towel, turn once.
Whole meal, mixed, rye	1 slice (60–80 g)	150	15s–30s	3–5	Defrost in a covered container.
Loaf	500	150	6–8	15–20	Cover cutting surface.
Pastry					
Dry cakes e.g. cakes with short crust pastry	300	80	2–3	5–10	Set on a paper towel, cover.
Fruit flans baked on a baking sheet	400–450	80	4–8	10–20	As for dry cakes.
1 slice cheese cake	400	80	4–8	10–20	As for dry cakes.
1 slice covered apple tart	400	80	3–5	10–20	As for dry cakes.
Cream and butter-cream layer cakes	300–400	80	2–4	10–20	Begin defrosting of cakes in the appliance, then remove.
Melting food					
Chocolate/toppings	100	700	2–3		Break up into pieces, stir from time to time.
Butter	50	900	15s–45s		To warm set time for 30 s longer.
Heating of refrigerated food and drink					
1 jar baby food	125–250	450	30s–50s	2–3	Heat jar without lid. Stir after warming. Check temperature.
1 ready meal on a plate	350–400	900	2–3	2–3	Heat in a covered container. Place gravy alongside in a cup.
1 portion of meat	150	900	45s–1	2–3	All meat, except breaded meat, should be heated in a covered container.
1 portion vegetables, potatoes or rice	200	900	1–1min30	2–3	Heat in covered container, stir once.
1 cup soup	200 ml	900	1min20–2	2–3	Heat clear soup uncovered, cover thick soups. Stir.
Drinks					
Milk or baby food	200 ml	900	35–45	2–3	Remove any lids. Stir. Check temperature !
Boil 1 cup water	180 ml	900	1min30–2	2–3	Stir instant coffee or tea when the water has stopped boiling.

1 cup milk	200 ml	900	1min50–2	2–3	Heat milk till it is just hot enough to drink. Stir.
1 cup coffee (reheat)	200 ml	900	45–55	2–3	Stir. Check temperature !

Defrosting and heating of frozen convenience foods

1 portion meat with gravy	150	700	2–4	2–3	Heat in a covered container. Stir now and again.
1 portion meat with vegetables, garnish	350–450	700	7–14	2–3	As for meat with gravy.

Cooking vegetables

Cook all vegetables in a covered container.

Description	Weight (g)	Liquid added	Power (Watt)	Duration (min)	Standing time (min)	Remarks/Hints
Meat						
Cauliflower	500	1/8 l	900	8–10	2	Dot with butter.
Frozen broccoli	300	1/8 l	900	7–9	2	Stalks facing outwards.
Mushrooms	250	none	900	4–6	2	Cut into slices.
Frozen peas and carrots	300	½ cup	900	7–9	2	
Carrots	250	2-3 tsp.	900	6–8	2	Cut into cubes or slices.
Potatoes	250	2-3 tsp.	900	4–6	2	Peel and quarter.
Red/green peppers	250	none	900	4–6	2	Cut into cubes or slices.
Leeks	250	½ cup	900	4–6	2	Cut into rings or pieces.
Frozen Brussels sprouts	300	½ cup	900	7–9	2	

Cooking fish

Description	Weight (g)	Power (Watt)	Duration (min)	Standing time (min)	Remarks/Hints
Fish fillets	500	500	1–3	6–8	Cook covered, turn half way through cooktime.
Whole fish	800	1) 900	3–5	3	Cook during cooking.
	500	2) 450	9–11	3	Cook flat parts with aluminium foil.



The times stated here are for guidance only.

Care & cleaning

Do not attempt to tamper with or make any adjustments or repairs to any part of the oven. Repairs should only be made by an authorised service engineer.



Be sure the oven is off or the unit is unplugged before cleaning.

Do not clean your microwave oven with a vapor cleaner.

The oven must always be clean. Failure to clean the appliance regularly may damage its surfaces, reduce durability and lead to hazardous operation. Residue of food from spill-overs or splatters that is allowed to remain on the oven walls, door seal and door surface will absorb microwave energy causing it to burn on. This could reduce the efficiency of the oven, and possibly damage the oven interior.

Cleaning the accessories

(turnable and support)

Clean them with mild detergent after removing them from the cavity. The turntable support should be carefully handled.



The inside of the oven and turntable get very hot, so do not touch them immediately after use.

Cleaning the interior

Use mild, liquid detergent, warm water and a soft, clean cloth to remove soilage.

NEVER USE ABRASIVE CLEANERS, COMMERCIAL OVEN CLEANERS OR STEEL WOOL PADS ON ANY PART OF THE MICROWAVE OVEN.

To loosen difficult soilage, boil a cup of water in the microwave oven for 2 or 3 minutes. NEVER USE A KNIFE OR ANY UTENSIL TO REMOVE SOILAGE FROM OVEN SURFACES.

To remove odours from the oven interior, boil a cup of water plus 2 tablespoons of lemon juice for 5 minutes.

Cleaning the exterior

Open the oven door when cleaning the control panel. This will prevent the oven from being turned on accidentally. You should clean outside surfaces of the oven with mild liquid detergent and water followed by a wiping with clear water to remove any excess detergent. Dry with a soft cloth. Pay special attention to the door seal and front of the cavity which must be kept clean at all times. If these surfaces are damaged because of excessive soiling, call in a specialised technician before using your microwave oven. Spray-on window cleaners or all purpose spray-on kitchen cleaners can also be used. Never use abrasive cleaners, scouring pads or harsh chemicals on outside surfaces of your oven. To prevent damage to the working parts, do not allow water to seep into ventilation openings.

If the microwave does not function

What to do if...

... the microwave appliance is not working properly ?

Check that

- the fuses in the fuse box are working,
- there has not been a power outage.
- If the fuses continue to blow, please contact a qualified electrician.

... the microwave mode is not working ?

Check that

- the door is properly closed,
- the door seals and their surfaces are clean,
- the START-button has been pressed

... the turntable is not turning ?

Check that

- the turntable support is correctly connected to the drive,
- the ovenware does not extend beyond the turntable,
- food does not extend beyond the edge of the turntable preventing it from rotating.
- there is nothing in the well beneath the turntable.

What to do if...

... the microwave will not switch off ?

- Isolate the appliance from the fuse box.
- Contact your local HUSQVARNA Service Force Centre.

... the interior light is not working ?

- Call your local HUSQVARNA Service Force Centre. The interior light bulb can be exchanged only by trained HUSQVARNA technicians.

... the food is taking longer to heat through and cook than before ?

- Set a longer cooking time (double quantity = nearly double time) or
- if the food is colder than usual, rotate or turn from time to time or
- set a higher power setting.

Service and spare parts

In the event of your appliance requiring service, or if you wish to purchase spare parts, please contact your local Husqvarna Service Force Centre. Before calling out an engineer, please ensure you have made the above checks. When you contact the Service Force Centre you will need to give the following details:

1. Your name, address and post code
2. Your telephone number
3. Clear and concise details of the fault
4. The model and serial number of the appliance (found on the rating plate)
5. The purchase date

In-guarantee customers should ensure the necessary checks have been made as the engineer will make a charge if the problem is not a mechanical or electrical breakdown.

Please note that proof of purchase will be required for in-guarantee calls.

For general enquiries concerning your Husqvarna appliance or for further information on Husqvarna products, please contact our Customer Care Department by letter or telephone.

Technical data

	<u>QN 4021</u>	<u>QN 4039</u>		<u>QN 4021</u>	<u>QN 4039</u>
Overall dimension :					
Height	297 mm	316 mm	Power	230-240V	220-240V
Width	440 mm	540 mm		50 Hz	50 Hz
Depth	331 mm	416 mm	Fuse	10A	10A
Cavity :			Power consumption	1250W	1550 W
Height	205 mm	210 mm	Power output	750 W	900 W
Width	282 mm	350 mm	Volume	17l	24 l
Depth	285 mm	351 mm	Net weight	15 kg	18 kg

Guarantee conditions

Standard guarantee conditions

We, Husqvarna, undertake that if within 24 months of the date of the purchase this Husqvarna appliance or any part thereof is proved to be defective by reason only of faulty workmanship or materials, we will, at our option repair or replace the same FREE OF CHARGE for labour, materials or carriage on condition that:

- The appliance has been correctly installed and used only on the electricity supply stated on the rating plate.
- The appliance has been used for normal domestic purposes only, and in accordance with the manufacturer's instructions.
- The appliance has not been serviced, maintained, repaired, taken apart or tampered with by any person not authorised by us.
- All service work under this guarantee must be undertaken by an Husqvarna service centre.
- Any appliance or defective part replaced shall become the Company's property.
- This guarantee is in addition to your statutory and other legal rights.

Home visits are made between **8.30am** and **5.30pm** Monday to Friday. Visits may be available outside these hours in which case a **premium** will be charged.

Exclusions

This guarantee does not cover:

- Damage or calls resulting from transportation, improper use or neglect, the replacement of any light bulbs or removable parts of glass or plastic.
- Appliances found to be in use within a commercial or similar environment, plus those which are subject to rental agreements.
- Products of Husqvarna manufacture which are not marketed by Husqvarna.

European Guarantee

If you should move to another country within Europe then your guarantee moves with you to your new home subject to the following qualifications:

The guarantee starts from the date you first purchased your product.

The guarantee is for the same period and to the same extent for labour and parts as exist in the new country of use for this brand or range of products.

This guarantee relates to you and cannot be transferred to another user. Your new home is within the European Community (EC) or European Free Trade Area.

The product is installed and used in accordance with our instructions and is only used domestically, i.e. a normal household

The electrical supply complies with the specification given in the rating label.

The product is installed taking into account regulations in your new country.

Before you move, please contact your nearest Customer Care centre, listed below, to give them details of your new home. They will then ensure that the local Service Organisation is aware of your move and able to look after you and your appliances.

France: Senlis +33 (0) 3 44 62 22 22

Germany :

Nürnberg +49 (0) 911 323 2600

Italy: Pordenone +39 (0) 1678 47053

Sweden:

Stockholm +46 (0) 20 78 77 50

UK: Slough +44 (0) 1753 219 898



 **From the Electrolux Group.** *The world's No.1 choice.*

The Electrolux Group is the world's largest producer of powered appliances for kitchen, cleaning and outdoor use. More than 55 million Electrolux Group products (such as refrigerators, cookers, washing machines, vacuum cleaners, chain saws and lawn mowers) are sold each year to a value of approx. USD 14 billion in more than 150 countries around the world.
Download from www.Somanuals.com. All Manuals Search And Download.

99627281 -1/2/02

Free Manuals Download Website

<http://myh66.com>

<http://usermanuals.us>

<http://www.somanuals.com>

<http://www.4manuals.cc>

<http://www.manual-lib.com>

<http://www.404manual.com>

<http://www.luxmanual.com>

<http://aubethermostatmanual.com>

Golf course search by state

<http://golfingnear.com>

Email search by domain

<http://emailbydomain.com>

Auto manuals search

<http://auto.somanuals.com>

TV manuals search

<http://tv.somanuals.com>